

LS ELECTRIC L7C AC Servo Systems

Drive features

- Power: 100W–1kW single-phase 220VAC
- Fully digital with up to 1kHz velocity loop response
- Easy setup and diagnostics with built-in keypad/display or the DriveCM PC-based software
- Field upgradeable firmware ensures the drive can always be upgraded to the latest operating system
- Command options include:
 - $\pm 10V$ torque or velocity command
 - Pulse train or master encoder position command (accepts line driver or open collector) with real-time selectable electronic gearing
 - Internal Indexer for position/speed-based moves. 64 individual move statements can be configured in the drive. Each Index contains its own distance, speed, accel, decel, and dwell parameters. These indexes can be set up through DriveCM software or modified in real-time with serial communication (PLC, HMI, etc.). The indexes can be initiated via Digital Inputs or through serial comms.
- The 1 kHz bandwidth allows for high-level automatic tuning. Several modes of tuning are available including Off-Line Auto Tuning (the drive initiates its own move commands while Auto tuning), On-Line Auto Tuning (an external controller sends the move commands while the drive Auto tunes), and Manual Tuning (all tuning values are adjusted by the user).
- Optically isolated digital inputs (10) and (5) general purpose (user-configurable) outputs + (3) outputs permanently configured as alarm/status binary code, analog inputs for speed and torque control (2), and line driver output for encoder (with scalable resolution).
- Advanced Scope feature that can monitor a variety of command and status signals, including output speed, torque, power, etc.



Motor features

- Low inertia models:
 - 100W, 200W, 400W, 750W and 1kW
 - Speeds up to 5,000 rpm
- Permanent magnet 3-phase synchronous motor
- Keyed drive shafts support clamp-on style couplings or key-style couplings
- Integrated encoder with 17-bit resolution (131,072 pulses per revolution)
- Optional 24 VDC spring-set holding brakes (AYK2 motors)
- Standard hook-up cables for motor power, encoder, and brake (separate brake cable for brake motors)
- Motor cables available in standard or flex-rated lengths of 3, 5, 10, and 20m
- Standard 50-pin DIN-rail mounted break-out kit for the drive's CN1 connector (with screw terminal connections), or 50-pin cables with flying leads

Note: These parts available for sale to North American locations only.

Tuning Technology

The L7C drive closes the loop on current, velocity, and position (depending on control mode selection). The 1kHz bandwidth in the drive assures precise speed and current control and easy tuning. Proportional gain, integral gain and compensation, feed forward compensation, command low pass filter, and four (4) notch filters for resonance suppression are available. Auto Tuning has been greatly improved and can tune FBL/FCL motors up to 20:1 inertia mismatch.

There is an inertia estimation function that analyzes the motor and load to measure how much inertia is coupled to the motor.

The drive has several tuning methods available:

- Online Auto Tuning—the drive can either tune the load live while an external controller moves the load to different positions or using the drive's internal tuning motion profile.
- Offline Auto Tuning—the drive tunes the load using the drive's internal tuning motion profile.
- Manual Tuning—all parameters are available to give power users the ultimate flexibility to tune their systems.

Built-in Indexer

While the L7C drives can accept traditional commands from host controllers, they can also provide their own internal motion control. 64 point-to-point position moves can be configured in the drive. These moves can be populated through the DriveCM configuration software or they can be written to by a PLC through the drive's RS422/485 serial port. The moves can be initiated by digital inputs or by serial commands, and can be sequenced internally with delays in between the moves or moves can be linked together so they are processed one after the other.

Multi-axis systems can be controlled via digital inputs, or serial communication. The motion can be commanded from a powerful external controller that sends out high speed pulses to each drive, or the motion can be initiated by a low-level controller (the simplest CLICK PLC) since each drive has a powerful indexer inside. Applications include press feeds, auger fillers, rotary tables, robots for pick and place, test or assembly operations, drilling, cutting, tapping, and similar applications using simple index moves for single or multi-axis motion.

Optional Holding Brake

Each L7C motor can be ordered with an optional 24VDC spring-set holding brake that holds the motor in place when power is removed.

LS Electric MSS Series In-Line Planetary Precision Gearboxes for Servo Motors

Need more torque from the motor? Have an inertia balancing issue in your design? The LS Electric MSS series gearboxes easily mate to FBL/FCL motors. Everything you need to mount your LS electric servo is included!

- Three gear ratios available (5:1, 10:1, 20:1)
- Mounting hardware included for attaching to FBL/FCL motors.
- Industry-standard mounting dimensions
- Thread-in mounting style
- Very low backlash: 7 arc-min single stage (5:1 and 10:1 ratios), 9 arc-min for two-stage (20:1 ratios).
- 1-year warranty



LS ELECTRIC L7C Series AC Servo Systems

Servo drive overview

LED Display

The 5-digit display is used to indicate servo status and alarm. The keys can be used to configure the drive and to set up monitoring values (but we highly recommend using the Drive CM software instead).

Model Number

Clearly displayed on the front panel for easy identification.

Main Power Terminal

Incoming single phase 200-230 VAC (-15% to +10%, 50/60Hz)

Regenerative Resistor Terminal

Connection for optional external braking resistor (APCS-140R50-AD or APCS-300R30-AD)

Motor Output Terminal

Output power to the servo motor. LS motor power cables available in 3, 5, 10, and 20 meter lengths in standard and flexing cables.

Ground Terminals

Separate ground screws for incoming power supply ground and motor cable ground.

Keypad

Four Function keys:
MODE, UP, DOWN, SET

USB Connector

Used by Drive CM software for servo configuration. Connect with a standard USB A to USB miniB cable (SV2-PGM-USB15, MOSAIC-CSU, or similar).

CN1 I/O Signal Connector

50-pin CN1 connector for drive I/O. Signals include high speed pulse inputs, 10 digital inputs, 8 digital outputs, 2 analog inputs (voltage and torque), serial Modbus RS422 (compatible with RS485 PLCs) and scalable encoder output.

Encoder Connector

14-pin CN2 connector for the motor encoder. LS Encoder cables available in 3, 5, 10, and 20 meter lengths in standard and flexing cables.

The LS Electric L7C servo drives are fully digital and include over 300 parameters to configure the drive for almost any application. For convenience, the parameters are grouped into several categories including:

- Basic parameters
- Gain parameters
- I/O parameters
- Velocity parameters
- Misc. parameters
- Monitor parameters
- Index parameters

All parameters have commonly used default values which allow you to operate the L7C drive "out-of-the-box". The drive auto-detects the

LS servo motor (through the serial encoder) and sets up the default gains and limits based on the connected motor.

The drive can still be easily configured to your specific application, however. The Drive CM configuration software has a built-in Setup Wizard that will guide you through all the basic setup parameters. So, whether you want to use high speed pulse input, analog velocity, analog torque, or the powerful internal indexer for a control mode (or any multi-mode combination of these modes), the Setup Wizard will quickly and easily get your application started – from setting up the I/O to determining the appropriate homing sequence.

After configuration is complete, the Auto Tune features of the drive will get your application tuned for optimal responsiveness and performance.

LS ELECTRIC L7C Series AC Servo Systems

Servo motor overview

Encoder Connector

9-pin watertight connector (8 pins used) for the 17-bit serial encoder. The encoder transmits motor/encoder identification information to the drive at power-up and it sends position feedback during operation.

Low Inertia Motors

Low inertia designs result in high responsiveness and high speeds.

- 100W 60mm flange
- 200W 60mm flange
- 400W 60mm flange
- 750W 80mm flange
- 1kW 80mm flange

Non-Braking Motor

Motor Power Connector

4-pin watertight connector for motor power (U, V, W, and ground)

Keyed Shafts

"FBL and FCL motors are supplied with extra-large keyways, and slightly oversized keys which must be "fitted" into the keyway for performance and longevity. Clamp or compression couplings (without key) are recommended".

- 100W 14mm diameter shaft
- 200W 14mm diameter shaft
- 400W 14mm diameter shaft
- 750W 19mm diameter shaft
- 1kW 19mm diameter shaft



IP67 Housing

All LS Electric L7C motors have keyed shafts for use with servo-grade clamp or compression couplings (recommended) or servo-grade keyed couplings. Some sanding/filing of the key may be required before pressing into the keyway. Do not modify the shaft/keyway.

Encoder Connector

9-pin watertight connector (8 pins used) for the 17-bit serial encoder. The encoder transmits motor/encoder identification information to the drive at power-up and it sends position feedback during operation.

Brake Power Connector

2-pin watertight connector available on brake motors only. The 24VDC brake is located between the motor coils and the encoder. Motors ending in AYK2 have brakes. The brakes must have 24VDC applied to them before the motor is set in motion.

Brake Motor

Motor Power Connector

4-pin watertight connector for motor power (U, V, W, and ground)

Keyed Shafts

"FBL and FCL motors are supplied with extra-large keyways, and slightly oversized keys which must be "fitted" into the keyway for performance and longevity. Clamp or compression couplings (without key) are recommended".

- 100W 14mm diameter shaft
- 200W 14mm diameter shaft
- 400W 14mm diameter shaft
- 750W 19mm diameter shaft
- 1kW 19mm diameter shaft



IP67 Housing



LS Electric AC Servo Systems

Drive Software

Drive CM Configuration Software

Drive CM is an optional free downloadable configuration software package for LS Electric servo drives. A PC may be directly connected to the servo drive via any standard USB-A to USB mini-B cable (SV2-PGM-USB15 or SV2-PGM-USB30 recommended).

Features

- Easy-to-use setup wizard guides you through the most common setup functions.
- Digital I/O / Jog Control allows the user to operate the servo system from the PC. This allows the servo to perform some basic motion and check the I/O during startup.
- Parameter Object editor for setting up all drive parameters.
- Tune and check the servo response in real-time using the scope feature.
- Upload and download the drive configuration. Save the drive configuration as a file for backup or future use.
- Edit the drive configuration.
- View all drive faults.
- View drive variable trends in real-time.
- (L7P/L7C series only) Set up 64 internal Indexes (point-to-point moves) that can be triggered by digital inputs or serial communications. Indexes can repeat and can initiate another Index when one move completes.

Download

Download the Drive CM software from AutomationDirect's LS Electric support page:

<https://support.automationdirect.com/products/lselectric.html>

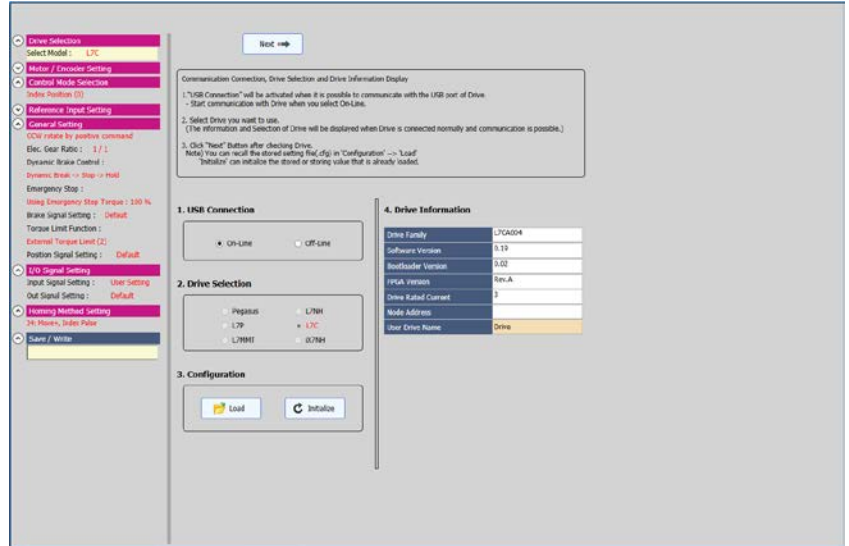

Setup Wizard Screen

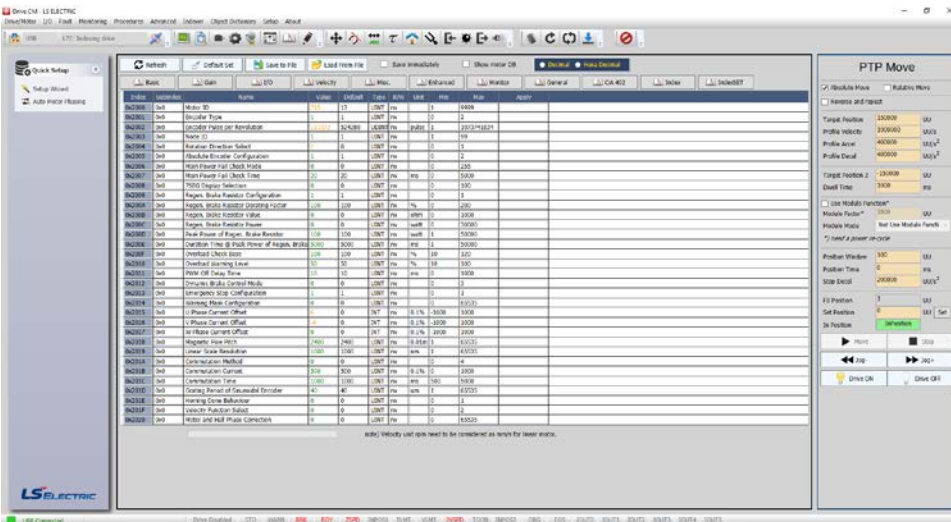

Drive CM Software Interface

Parameter Object Editor

The Drive CM configuration tool logically organizes all servo drive object parameters for viewing and editing using the Object Dictionary screen. Each parameter has a factory default that usually allows the servo to run "out-of-the-box".

The parameters can be easily changed with available setting ranges displayed. Tuning modes and parameters can also be changed using Drive CM. After the parameters have been defined, the complete setup can be stored and archived. Drive configurations can be uploaded, edited, saved, and downloaded as often as necessary.

Using the Drive CM software you can also configure and commission your drive without having to be connected to the master controller.



LS Electric AC Servo Systems

Drive Software, *continued*

Digital I/O, Jog Control, and Scope

The Digital I/O / Jog Control screen allows the user to operate the servo system from the PC. This is a great aid during start-up to allow the servo to perform some basic motion and to check the I/O.

Drive CM also includes a powerful scope function that allows the user to have as many as four channels of data displayed simultaneously. Each channel has a drop-down table to select the data to be displayed. The scope has the ability to save traces to a file and load those traces for offline review/analysis. This function is a valuable tool for tuning LS Electric servo drives.

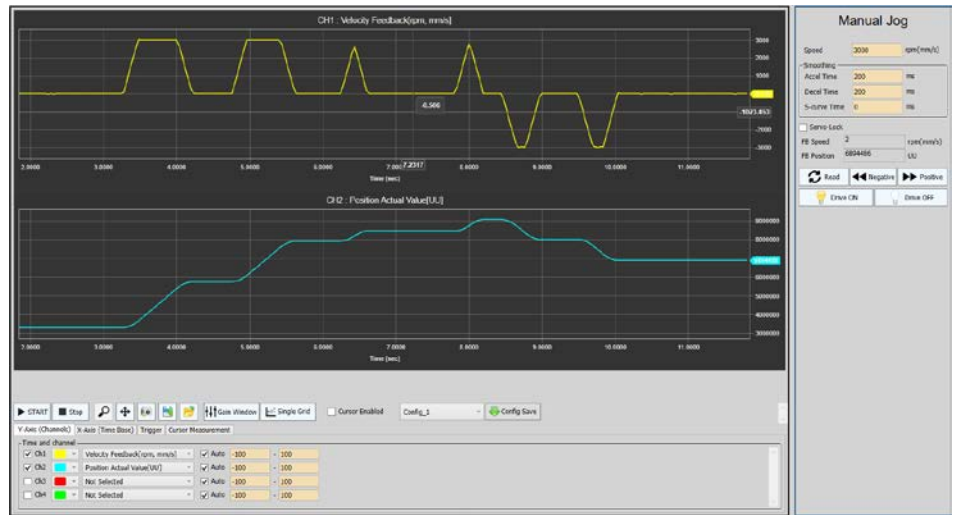

Jog Control / Scope Screen

General Setup Screen

Alarm History Screen

Indexer Setting Screen (L7P/L7C series only)

Object Dictionary Screen

LS ELECTRIC L7C AC Servo Systems

How to select and apply L7C systems

The primary purpose of the AC servo system is to precisely control the motion of the load. The most fundamental considerations in selecting the servo system are “reflected” load inertia, servo system maximum speed requirement, servo system continuous torque requirement, and servo system peak torque requirement. In a retrofit application, select the largest torque servo system that most closely matches these parameters for the system being replaced. In a new application, these parameters should be determined through calculation and/or

measurement. The Drive CM software has the ability to measure the load (reflected) inertia and accurately measure the motor torque output.

AutomationDirect has teamed with Copperhill Technologies to provide free servo-sizing software. “VisualSizer-SureServo” software will assist in determining the correct motor and drive for your application by calculating the reflected load inertia and required speed and torque based on the load configuration. “VisualSizer-SureServo” software can be downloaded from <https://support.automationdirect.com/products/sureservo.html>.

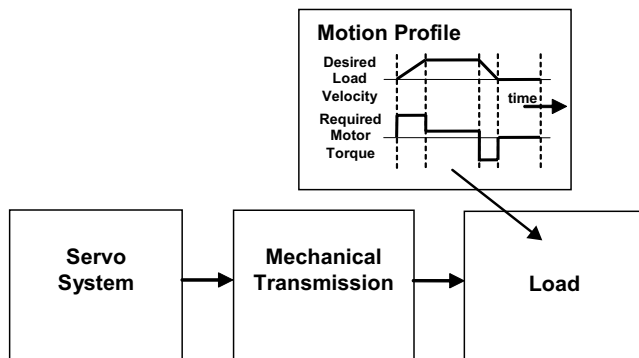

1. “Reflected” load inertia

The inertia of everything attached to the servo motor driveshaft needs to be considered and the total “reflected” inertia needs to be determined. This means that all elements of any mechanical transmission and load inertia need to be translated into an equivalent inertia as if attached directly to the motor driveshaft. The ratio of “reflected” load inertia to motor inertia needs to be carefully considered when selecting the servo system.

In general, applications that need high response or bandwidth

will benefit from keeping the ratio of load inertia to motor inertia as low as possible and ideally under 10:1. L7C Auto Tuning will still tune a system with very high response, up to 20:1 inertia mismatch. Higher system ratios can be implemented, but corresponding lower bandwidth or responsiveness must be accepted. The servo response including the attached load inertia is determined by the servo tuning. The L7C servo systems may be tuned automatically by the software/drive or manually by the user.

2. Torque and speed

With knowledge of the motion profile and any mechanical transmission between the motor and load, calculations can be made to determine the required servo motor continuous torque, peak torque, and maximum motor speed. The required amount of continuous torque must fall inside the continuous operating region of the system torque-speed curve (you can check the continuous torque at the average speed of the motion profile). The required amount of peak torque must also fall within the servo system’s intermittent operating region of the system torque-speed curve (you need to check this value at the required maximum speed or torque). If you have an L7C system, these values are easily captured and recorded with the Scope feature built into the Drive CM software. If you are designing the system from scratch, use VisualSizer to define the system and calculate expected inertia and required power.

Compare the application’s Continuous and Intermittent torque requirements to the torque-speed curves found in Chapter 16 of the L7C User Manual.

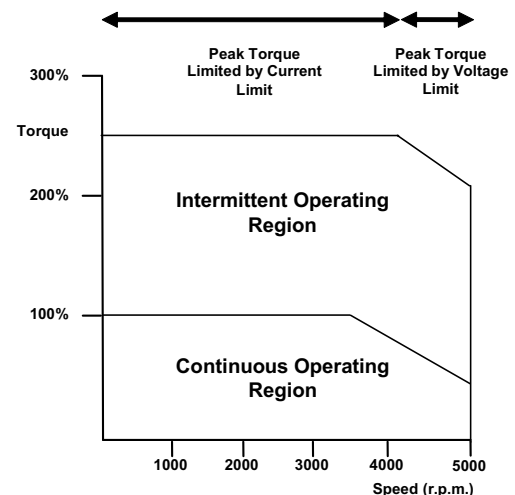

LS ELECTRIC L7C AC Servo Systems

Application tip - coupling considerations

The LS Electric FBL/FCL motors have keyed shafts that can be used with keyed couplings or with clamp-on or compression style couplings. For standard keyed couplings, the servo key must be "fitted" into the keyway for optimum performance and longevity. Some minor filing and pressing of the key may be required. "Servo-grade" clamp-on or compression style couplings

are usually the best choice when you consider stiffness, torque rating, and inertia. Higher stiffness (lb-in/radian) is needed for better response but there is a trade-off between stiffness and the added inertia of the coupling. Concerning the torque rating of the coupling, use a safety factor of 1.25 over the servo's **peak** torque requirement of your application.

[Click here for Available Couplings](#)

Mechanical transmissions

Common mechanical transmissions include leadscrews, rack & pinion mechanisms, conveyors, gears, and timing belts. The use of leadscrew, rack & pinion, or conveyor are common ways to translate the rotary motion of the servo motor into linear motion of the load. Matched gearboxes are available from LS Electric that will work with the FBL and FCL motors. Each gearbox is selected to accept the 300% maximum available torque that could be generated by the motor. Gearboxes are available in 5:1, 10:1, and 20:1 ratios. The use of a speed reducer such as a gearbox or timing belt can be very beneficial as follows:

1. Reduction of reflected load inertia

As a general rule, it is beneficial to keep the reflected load inertia as low as possible while using the full range of servo speed. The LS Electric motors can rotate at a rated speed of 3000rpm (rated torque at rated speed). Their max speed (slightly less available torque) is 5000rpm. See the speed-torque curves for more information.

Example: A gearbox reduces the motor's required torque by a factor of the gear ratio, and reduces the reflected load inertia by a factor of the gear ratio squared. A 10:1 gearbox reduces output speed to 1/10, increases output torque 10 times, and decreases reflected inertia to 1/100.

However, when investigating the effect of different speed reduction ratios DO NOT forget to include the added inertia of couplings, gearbox, or timing belt pulleys. These added inertias can be significant, and can negate any inertia reduction due to the speed reduction.

2. Low speed and high torque applications

If the application requires low speed and high torque then it is common to introduce a speed reducer so that the servo system can operate over more of the available speed range. This could also have the added benefit of reducing the servo motor torque requirement which could allow you to use a smaller and lower cost servo system. Additional benefits are also possible with reduction in reflected inertia, increased number of motor encoder counts at the load, and increased ability to reject load disturbances due to mechanical advantage of the speed reducer.

3. Space limitations and motor orientation

FBL/FCL motors can be mounted in any orientation, but the shaft seal should not be immersed in oil (open-frame gearbox, etc.). Reducers can possibly allow the use of a smaller motor or allow the motor to be repositioned.



Motor	Brake Motor	LS Electric MSS Planetary In-Line Gearboxes		
		5:1 Gearbox	10:1 Gearbox	20:1 Gearbox
APMC-FBL01AYK-AD	APMC-FBL01AYK2-AD	96200004 (MSS0601A-005KS-B3110103C14)	96200005 (MSS0601A-010KS-B3110103C14)	96200103 (MSS0902B-020KS-B3110103C14)
APMC-FBL02AYK-AD	APMC-FBL02AYK2-AD			
APMC-FBL04AYK-AD	APMC-FBL04AYK2-AD			
APMC-FCL08AYK-AD	APMC-FCL08AYK2-AD	96200007 (MSS0901A-005KS-C3110103C19)	96200008 (MSS0901A-010KS-C3110103C19)	96200257 (MSS1152B-020KS-C3110103C19)
APMC-FCL10AYK-AD	APMC-FCL10AYK2-AD			

Here is a link to our [Timing Belts and Pulleys](#)

Ordering guide instructions

The following four pages are your ordering guide for LS Electric L7C servo systems. Each system has a torque-speed curve included for reference. This is the fundamental information that you need to select the servo motor and matching drive for your application.

Each system needs:

- Motor
- Drive
- Motor Power Cable
- Motor Encoder Cable
- I/O connections (either a 50-pin CN1 cable+terminals kit or a 50-pin flying lead cable(user provides terminal blocks))
- For brake motors you will also need a brake cable (connectorized on the motor end, two ferruled flying leads on the opposite end).

LS ELECTRIC L7C Series AC Servo Systems

L7C series drives and motors part numbering system

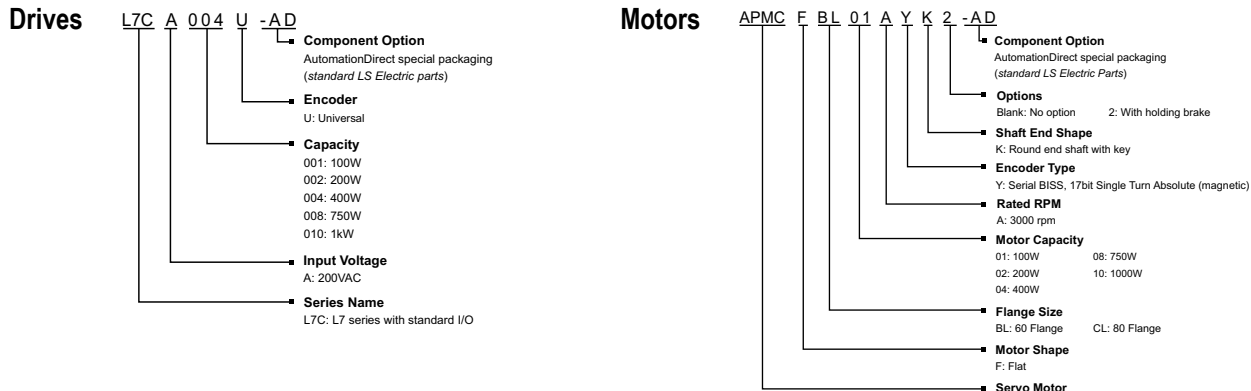

Example of what you will need to build a complete servo system:



NOTE: Unit can be programmed via keypad. Optional programming software (free download). Use a standard USB-A to USB miniB cable for connectivity (SV2-PGM-USB15, MOSAIC-CSU, or equivalent)

NOTE: If you need a gear box for your configuration, reference the gearbox chart on the previous page. Ratios of 5:1, 10:1, and 20:1 are available for each FBL/FCL motor.



Torque to L7C System Quick Reference

System Rated Torque (N·m)	System Maximum Torque (N·m)	Suggested Servo Motor	Required Servo Drive
0.32	0.96	APMC-FBL01AYK-AD	L7CA004U-AD
		APMC-FBL01AYK2-AD	
0.64	1.91	APMC-FBL02AYK-AD	
		APMC-FBL02AYK2-AD	
1.27	3.82	APMC-FBL04AYK-AD	
		APMC-FBL04AYK2-AD	
2.39	7.16	APMC-FCL08AYK-AD	L7CA010U-AD
		APMC-FCL08AYK2-AD	
3.18	9.55	APMC-FCL10AYK-AD	
		APMC-FCL10AYK2-AD	

LS ELECTRIC L7C Series AC Servo Systems

L7C AC servo drive, motor, and cable combinations

xx = Cable length in meters

BN, EN, or PN = Standard cable (not continuous flex)

BF, EF, or PF = Flex-rated cable

AYK motors = no brake

AYK2 motors = mechanical holding brake

Type	System Torque Chart	L7C Drive	APMC Motor	Power Cable	Encoder Cable	Brake Cable	I/O Cable and Breakout
100W Low Inertia System		L7CA004U-AD	APMC-FBL01AYK-AD	APCS-PNxxLSC-AD	APCS-ENxxES-AD	n/a	APC-VSCN1Txx-AD or APC-CN10xA-AD
				APCS-PFxxLSC-AD	APCS-EFxxES-AD	n/a	
			APMC-FBL01AYK2-AD	APCS-PNxxLSC-AD	APCS-ENxxES-AD	APCS-BNxxQS-AD	
				APCS-PFxxLSC-AD	APCS-EFxxES-AD	APCS-BFxxQS-AD	
200W Low Inertia System		L7CA004U-AD	APMC-FBL02AYK-AD	APCS-PNxxLSC-AD	APCS-ENxxES-AD	n/a	
				APCS-PFxxLSC-AD	APCS-EFxxES-AD	n/a	
			APMC-FBL02AYK2-AD	APCS-PNxxLSC-AD	APCS-ENxxES-AD	APCS-BNxxQS-AD	
				APCS-PFxxLSC-AD	APCS-EFxxES-AD	APCS-BFxxQS-AD	
400W Low Inertia System		L7CA004U-AD	APMC-FBL04AYK-AD	APCS-PNxxLSC-AD	APCS-ENxxES-AD	n/a	
				APCS-PFxxLSC-AD	APCS-EFxxES-AD	n/a	
			APMC-FBL04AYK2-AD	APCS-PNxxLSC-AD	APCS-ENxxES-AD	APCS-BNxxQS-AD	
				APCS-PFxxLSC-AD	APCS-EFxxES-AD	APCS-BFxxQS-AD	

LS ELECTRIC L7C Series AC Servo Systems

L7C AC servo drive, motor, and cable combinations, *continued*

Type	System Torque Chart	L7C Drive	APMC Motor	Power Cable	Encoder Cable	Brake Cable	I/O Cable and Breakout
750W Low Inertia System		L7CA010U-AD	APMC-FCL08AYK-AD	APCS-PNxxLSC-AD	APCS-ENxxES-AD	n/a	APC-VSCN1Txx-AD or APC-CN10xA-AD
				APCS-PFxxLSC-AD	APCS-EFxxES-AD	n/a	
			APMC-FCL08AYK2-AD	APCS-PNxxLSC-AD	APCS-ENxxES-AD	APCS-BNxxQS-AD	
				APCS-PFxxLSC-AD	APCS-EFxxES-AD	APCS-BFxxQS-AD	
1.0kW Low Inertia System		L7CA010U-AD	APMC-FCL10AYK-AD	APCS-PNxxLSC-AD	APCS-ENxxES-AD	n/a	APC-VSCN1Txx-AD or APC-CN10xA-AD
				APCS-PFxxLSC-AD	APCS-EFxxES-AD	n/a	
			APMC-FCL10AYK2-AD	APCS-PNxxLSC-AD	APCS-ENxxES-AD	APCS-BNxxQS-AD	
				APCS-PFxxLSC-AD	APCS-EFxxES-AD	APCS-BFxxQS-AD	

LS ELECTRIC L7C Series AC Servo Systems

L7C Servo drive specifications

L7C Servo Drive Specifications			
Model	<u>L7CA004U-AD</u>	<u>L7CA010U-AD</u>	
Price	\$286.00	\$360.00	
Drawing	PDF	PDF	
Power	Input Power	Single phase AC200 - 230V(-15 to +10%), 50-60Hz	
	Rated Current [Amps]	3.6	8.0
	Peak Current [Amps]	9.0	20.25
	Inrush Current	34A @ 240VAC	36A @ 240VAC
Control Performance	Speed Control Range	Maximum 1:5000	
	Frequency Response	Maximum 1KHz or above (when using 17-Bit Serial Encoder)	
	Speed Variation Ratio	± 0.01 % or lower (when load changes between 0 and 100%), ± 0.1 % or lower (temperature 25±10°C)	
	Accel/Decel Time	Straight or S-curve acceleration/deceleration (0-10,000 ms), increment by 1ms	
	Input Frequency	1Mpps, line driver / 200kpps, open collector	
	Input Pulse Type	Pulse+Direction, CW+CCW, A/B Phase	
Recommended Breaker	5A max	10A max	
Recommended Fuse	15A max	30A max	
SCCR Rating	5000A		
RS-422	Specification	ANSI/TIA/EIA - 422 standard specifications - connects to PLCs with RS485 ports (Click, P-Series, Do-More, etc.)	
	Protocol	MODBUS-RTU	
	Synchro Method	Asynchronous	
	Power Consumption	100mA	
	Transmission Speed (bps)	9,600 / 19,200 / 38,400 / 57,600	
	Distance	200m maximum	
	Terminating Resistance	Optional built-in 120Ω resistor for end-of-line termination	
Digital I/O Specifications	Digital Input	Input voltage range: 12-24 VDC Total 10 input channels (configurable) 34 different selectable functions for assignment. (*SV_ON, *SPD/LVSF1, *SPD2/LVSF2, *SPD3, *A-RST, *JDIR, *POT, *NOT, *EMG, *STOP, START, REGT, HOME, HSTART, ISEL0, ISEL1, ISEL2, ISEL3, ISEL4, ISEL5, PCON, GAIN2, P_CL, N_CL, MODE, PAUSE, ABSRQ, JSTART, PCLR, AOVR, INHIBIT, EGEAR1, EGEAR2, ABS_RESET)	
	Digital Output	Service rating: 24VDC ± 10%, 120mA 5 of 8 output channels are configurable, 3 channels are fixed with AL00, AL01, and AL02 19 different selectable functions for assignment (*ALARM, *READY, *ZSPD, *BREAK, *INPOS1, ORG, EOS, TGON, TLMT, VLMT, INSPD, WARN, INPOS2, IOUT0, IOUT1, IOUT2, IOUT3, IOUT4, IOUT5)	
Analog Input	2 channel Analog speed input (Command/Override) ± 10V Analog torque input (Command/Override) ± 10V		
USB Communication	Connect	PC	
	Communication Standard	USB 2.0 full speed (applies standard)	
	Specification	PC, USB 2.0 full speed (applies standard)	
Continued on next page			

* Basic allocation signal

LS ELECTRIC L7C Series AC Servo Systems

L7C Servo drive specifications, *continued*

L7C Servo Drive Specifications, <i>continued</i>			
<i>Continued from previous page</i>			
Model	<u>L7CA004U-AD</u>	<u>L7CA010U-AD</u>	
Internal Function	Dynamic Braking	Standard built-in brake (activated when the servo alarm goes off or when the servo is OFF)	
	Regenerative Braking	3.0 kW capacity with external resistor APCS-140R50	5.0 kW capacity with external resistor APCS-300R30
	Display Function	7 segments (5DIGIT)	
	Additional Function	Gain tuning, alarm history, JOG operation, homing	
	Protection Function	Excessive current/voltage/overload/overheating/speed, excessive current limit, low voltage, encoder/ position following/current sensing fail	
Operation Environment	Operating Temperature	0–50 °C	
	Storage Temperature	-20 to -65°C	
	Operating Humidity	Below 80% relative humidity	
	Storage Humidity	Below 90% relative humidity (avoid dew-condensation)	
	Environment	Indoor, avoid corrosive, inflammable gas, or liquid and electrically conductive dust	
Approvals	cUL _{US} (E479434), CE		

LS ELECTRIC L7C Series AC Servo Systems

L7C Drive Standard Installation

L7C Drive Installation Spacing

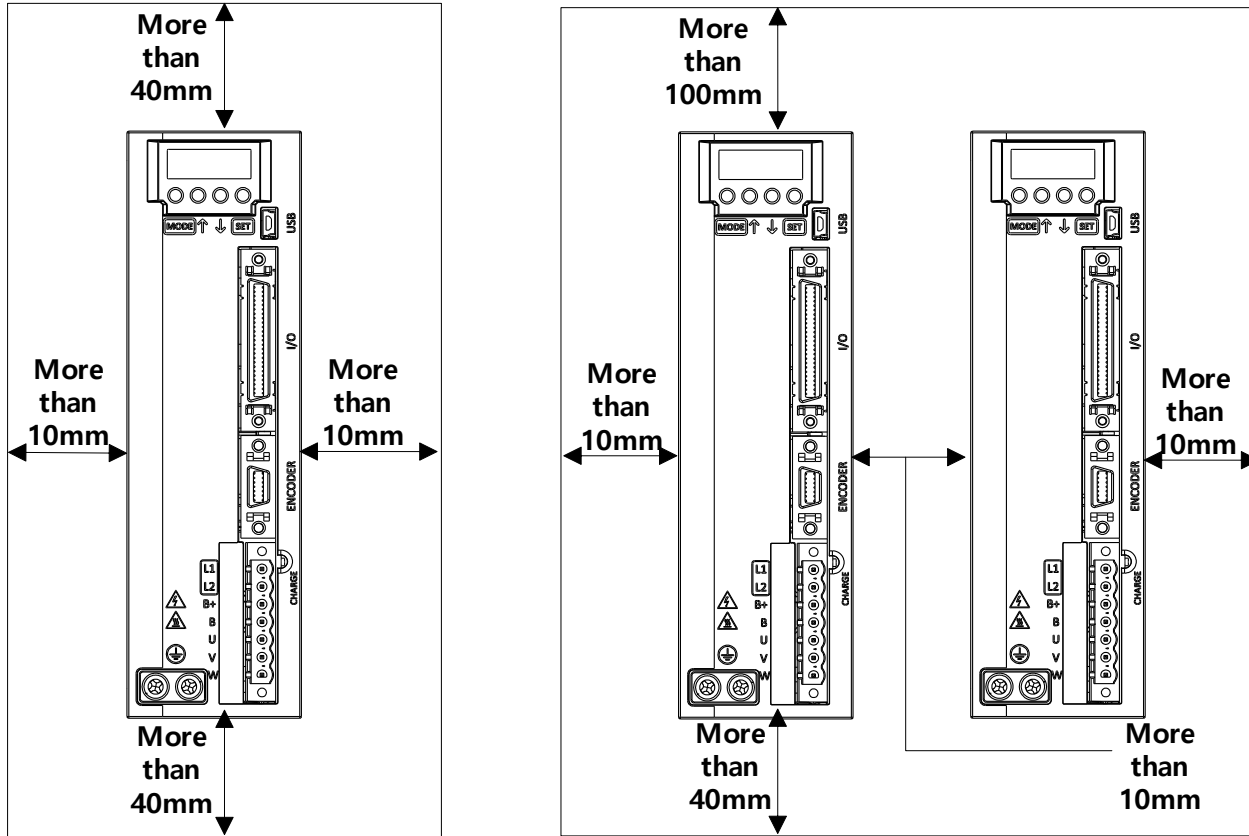

L7C Drive Installation Concerns:

- Install external regenerative resistors so that any heat generated does not affect the drive.
- Vertical installation only. For proper heat dissipation, ensure the back of the drive makes good contact with the subpanel.
- Protect the drive from metal chips and other falling debris during control panel assembly.
- Make sure that oil, water, or metal dust do not enter the drive.
- Protect the control panel by using an air purge system when installing it in any area where there are harmful gases or dust.

LS ELECTRIC L7C Series AC Servo Systems

L7C Drive Wiring

L7C Power Supply Wiring

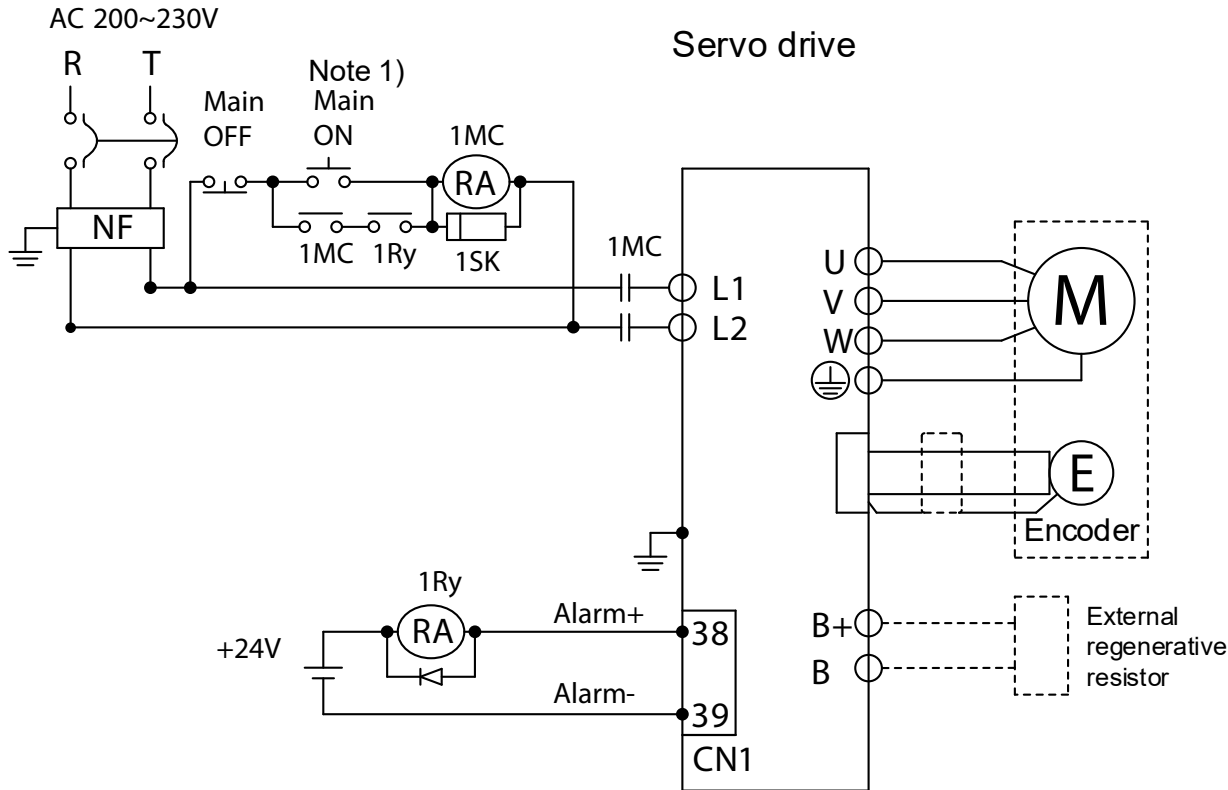

NOTE 1: About 1–2 seconds are required from main power supply to alarm signal output. Hold the main power on for 2 seconds until the alarm circuit (“1Ry”) will latch main power ON.

NOTE: If an external regen resistor is required, connect a regenerative resistance of 50W/100Ω for the L7CA004U-AD, and 100W/40Ω for the L7CA010U-AD.

Connect the L7C RS422 port to a PLC with an RS485 port:

To use RS422 with AutomationDirect PLCs with RS485 ports

PLC RS485 terminals

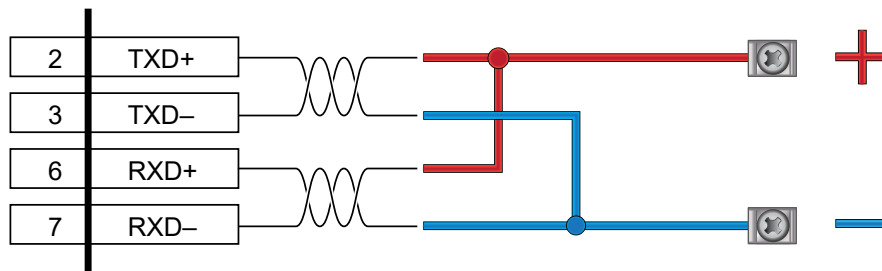

NOTE: Do not use APC-VSCN1T(xx)-AD feedthrough terminal block if using PLC/Drive serial communication. Communication errors may occur due to disconnects in cable shields. Use APC-CN10xA-AD flying lead cables.

LS ELECTRIC L7C Series AC Servo Systems

Non-brake Motor Specifications

L7C Non-brake Motor Specifications					
Model	APMC-FBL01AYK-AD	APMC-FBL02AYK-AD	APMC-FBL04AYK-AD	APMC-FCL08AYK-AD	APMC-FCL10AYK-AD
Price	\$210.00	\$248.00	\$260.00	\$308.00	\$376.00
Drawing	PDF	PDF	PDF	PDF	PDF
Flange Size	60	60	60	80	80
Rated Power [kW]	0.1	0.2	0.4	0.75	1
Rated Torque [N·m] Note 1	0.32	0.64	1.27	2.39	3.18
Max. Torque [N·m]	0.96	1.91	3.82	7.16	9.55
Rated Speed [rpm]	3000				
Max. Speed [rpm]	5000				
Mechanical Time Constant [ms]	0.926	0.518	0.374	0.609	0.492
Rated current [Amps] rms	0.95	1.45	2.6	5.02	5.83
Max. Instantaneous Current [Amps] rms	2.85	4.35	7.8	15.07	17.5
Rated Power Rate [kW/s]	11.09	27.6	27.07	45.09	62.08
Electrical Time Constant [ms]	2.416	3.488	4.271	5.774	6.919
Insulation Class	Class BE (CE, UL)				
Insulation Resistance	>10MΩ, 500VDC				
Insulation Strength	1.8 kVAC, 1 second				
Rotor Inertia [x10 ⁻⁴ kg m ²]	0.091	0.147	0.248	1.264	1.632
Allowable Load Inertia Ratio	20 times motor inertia			15 times motor inertia	
Max Radial Loading [N]	206			255	
Max Axial Loading [N]	69			98	
Vibration Grade [μm]	V15				
Vibration Capacity	19.6m/s ² or lower (2.5G)				

Note 1—The rated torque is the continuous permissible torque between the 0°C and 40°C operating temperature which is suitable for a servo motor mounted with the following heat sink dimensions: 250mm x 250mm x 6mm made from aluminum (or mounted to equipment with an equivalent heat sinking capability).

LS ELECTRIC L7C Series AC Servo Systems

Non-brake Motor Specifications, *continued*

L7C Non-brake Motor Specifications, <i>continued</i>					
Model	<u>APMC-FBL01AYK-AD</u>	<u>APMC-FBL02AYK-AD</u>	<u>APMC-FBL04AYK-AD</u>	<u>APMC-FCL08AYK-AD</u>	<u>APMC-FCL10AYK-AD</u>
Speed/Position Detector	Serial Single-Turn Encoder (17-bit), built-in				
IP Rating	Fully closed, self cooling IP67				
Rated Time	Continuous				
Operating Temperature	0°C to 40°C				
Storage Temperature	-10°C to 60°C				
Operating Humidity	Below 80% relative humidity				
Storage Humidity	Below 90% relative humidity, no condensation				
Atmosphere	Avoid direct sunlight, no corrosive gas, inflammable gas, oil mist, or dust				
E/V	Elevation/vibration 49m/s ² (5G)				
Weight [kg]	0.56	0.74	1.06	2.68	3.3
Agency Approvals	cUR _{US} (E255738), CE				

Note 1—The rated torque is the continuous permissible torque between the 0°C and 40°C operating temperature which is suitable for a servo motor mounted with the following heat sink dimensions: 250mm x 250mm x 6mm made from aluminum (or mounted to equipment with an equivalent heat sinking capability).

LS ELECTRIC L7C Series AC Servo Systems

Brake Motor Specifications

L7C Brake Motor Specifications					
Model	APMC-FBL01AYK2-AD	APMC-FBL02AYK2-AD	APMC-FBL04AYK2-AD	APMC-FCL08AYK2-AD	APMC-FCL10AYK2-AD
Price	\$386.00	\$434.00	\$444.00	\$484.00	\$569.00
Drawing	PDF	PDF	PDF	PDF	PDF
Flange Size	60	60	60	80	80
Rated Power [kW]	0.1	0.2	0.4	0.75	1
Rated Torque [N·m] Note 1	0.32	0.64	1.27	2.39	3.18
Max. Torque [N·m]	0.96	1.91	3.82	7.16	9.55
Rated Speed [rpm]	3000				
Max. Speed [rpm]	5000				
Mechanical Time Constant [ms]	0.926	0.518	0.374	0.609	0.492
Rated current [Amps] rms	0.95	1.45	2.6	5.02	5.83
Max. Instantaneous Current [Amps] rms	2.85	4.35	7.8	15.07	17.5
Rated Power Rate [kW/s]	11.09	27.6	27.07	45.09	62.08
Electrical Time Constant [ms]	2.416	3.488	4.271	5.774	6.919
Insulation Class	Class BE (CE, UL)				
Insulation Resistance	>10MΩ, 500VDC				
Insulation Strength	1.8 kVAC, 1 second				
Rotor Inertia [x10 ⁻⁴ kg m ²]	0.091	0.147	0.248	1.264	1.632
Allowable Load Inertia Ratio	20 times motor inertia			15 times motor inertia	
Max Radial Loading [N]	206			255	
Max Axial Loading [N]	69			98	
Brake Holding Torque [N·m (min)]	1.47			3.23	
Brake Power Consumption (at 20°C) [W]	6.5			9	
Brake Release Time [ms (max)]	20				
Brake Pull-in Time [ms (max)]	50			60	
Vibration Grade [μm]	V15				
Vibration Capacity	19.6m/s ² or lower (2.5G)				

Note 1—The rated torque is the continuous permissible torque between the 0°C and 40°C operating temperature which is suitable for a servo motor mounted with the following heat sink dimensions: 250mm x 250mm x 6mm made from aluminum (or mounted to equipment with an equivalent heat sinking capability).

LS ELECTRIC L7C Series AC Servo Systems

Brake Motor Specifications, *continued*

L7C Brake Motor Specifications, <i>continued</i>					
Model	APMC-FBL01AYK2-AD	APMC-FBL02AYK2-AD	APMC-FBL04AYK2-AD	APMC-FCL08AYK2-AD	APMC-FCL10AYK2-AD
Speed/Position Detector	Serial Multi-Turn Built-in Type (17-bit)				
IP Rating	Fully closed, self cooling IP67				
Rated Time	Continuous				
Operating Temperature	0°C to 40°C				
Storage Temperature	-10°C to 60°C				
Operating Humidity	Below 80% relative humidity				
Storage Humidity	Below 90% relative humidity, no condensation				
Atmosphere	Avoid direct sunlight, no corrosive gas, inflammable gas, oil mist, or dust				
E/V	Elevation/vibration 49m/s ² (5G)				
Weight [kg]	1.28	1.46	1.78	3.45	4.07
Agency Approvals	cUR _{US} (E255738), CE				

Note 1—The rated torque is the continuous permissible torque between the 0°C and 40°C operating temperature which is suitable for a servo motor mounted with the following heat sink dimensions: 250mm x 250mm x 6mm made from aluminum (or mounted to equipment with an equivalent heat sinking capability).

L7C/L7P Series AC Servo Systems

Accessories

CN1 Accessories

For L7x series drives, two methods are available for creating I/O connections.

Option 1:

Terminal blocks + cables:

- [APC-VSCN1T-AD](#)
- [APC-VSCN1T01-AD](#)
- [APC-VSCN1T02-AD](#)

APC-VSCN1T terminals ship with a universal labeling strip (A1-A25, B1-B25). A labeling template with designations specifically for the L7x drive can be downloaded from any of the drive pages or the terminal block page (www.automationdirect.com/pn/apc-vscn1t-ad).



APC-VSCN1T-AD

Option 2:

Flying lead cables:

- [APC-CN101A-AD](#)
- [APC-CN102A-AD](#)
- [APC-CN103A-AD](#)



APC-CN101A-AD



NOTE: For L7C drives, do not use APC-VSCN1T(xx)-AD feedthrough terminal block if using PLC/Drive serial communication. Communication errors may occur due to disconnects in cable shields. Use APC-CN10xA-AD flying lead cables.

Part Number	Price	Description	Cable Length	Drawing	Compatible Drives
APC-VSCN1T-AD	\$75.00	LS Electric CN1 feedthrough terminal block, 50-pole, DIN rail mount	0.5 m [1.6 ft]	PDF	All L7C and L7P drives
APC-VSCN1T01-AD	\$84.00		1.0 m [3.2 ft]	PDF	
APC-VSCN1T02-AD	\$92.00		2.0 m [6.5 ft]	PDF	
APC-CN101A-AD	\$46.00	LS Electric control cable, 50-pin connector to pigtail.	1.0 m [3.2 ft]	PDF	
APC-CN102A-AD	\$50.00		2.0 m [6.5 ft]	PDF	
APC-CN103A-AD	\$55.00		3.0 m [9.8 ft]	PDF	

LS ELECTRIC L7C Series AC Servo Systems

Accessories

L7C Terminal Assignment Table

CAUTION: This terminal assignment table is for use with L7C drives ONLY. Using this table with non-L7C series drives could damage your equipment as terminal assignments are different for each drive series.

APC-VSCN1T-AD

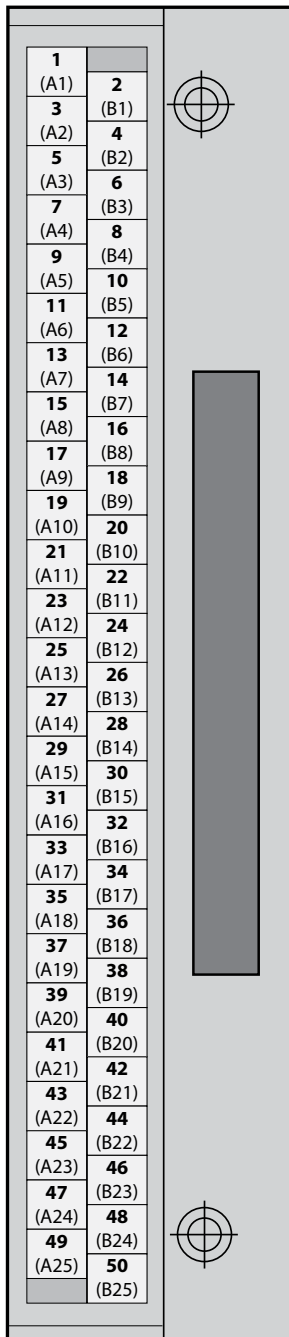

You can download a printable terminal label at <https://www.automationdirect.com/pn/APC-VSCN1T-AD>

L7C Drive Terminal Assignments					
Terminal	Drive I/O Pin/Wire #	Description	Wire Color	Stripe Color	Number of Stripes
A1	1	AI-1 (TRQCOM)	Orange	Black	1
B1	2	TXD+	Orange	Red	1
A2	3	TXD-	Orange	Black	2
B2	4	Z0	Orange	Red	2
A3	5	/Z0	Orange	Black	3
B3	6	RXD+	Orange	Red	3
A4	7	RXD-	Orange	Black	4
B4	8	A-GND	Orange	Red	4
A5	9	PF+	Orange	Black	5
B5	10	PF-	Orange	Red	5
A6	11	PR+	Yellow	Black	1
B6	12	PR-	Yellow	Red	1
A7	13	N/C	Yellow	Black	2
B7	14	DO-8	Yellow	Red	2
A8	15	DO-7	Yellow	Black	3
B8	16	DO-6	Yellow	Red	3
A9	17	DI-5	Yellow	Black	4
B9	18	DI-9	Yellow	Red	4
A10	19	DI-8	Yellow	Black	5
B10	20	DI-7	Yellow	Red	5
A11	21	DI-4	Gray	Black	1
B11	22	DI-3	Gray	Red	1
A12	23	DI-2	Gray	Black	2
B12	24	DO-GND24	Gray	Red	2
A13	25	DO-GND24	Gray	Black	3
B13	26	N/C	Gray	Red	3
A14	27	AI-2 (SPDCOM)	Gray	Black	4
B14	28	N/C	Gray	Red	4
A15	29	N/C	Gray	Black	5
B15	30	B0	Gray	Red	5
A16	31	/B0	White	Black	1
B16	32	AO	White	Red	1
A17	33	/AO	White	Black	2
B17	34	+12V	White	Red	2
A18	35	-12V	White	Black	3
B18	36	ENC SG	White	Red	3
A19	37	N/C	White	Black	4
B19	38	DO-1+	White	Red	4
A20	39	DO-1-	White	Black	5
B20	40	DO-2+	White	Red	5
A21	41	DO-2-	Pink	Black	1
B21	42	N/C	Pink	Red	1
A22	43	DO-3	Pink	Black	2
B22	44	DO-4	Pink	Red	2
A23	45	DO-5	Pink	Black	3
B23	46	DI-6	Pink	Red	3
A24	47	DI-1	Pink	Black	4
B24	48	DI-A	Pink	Red	4
A25	49	PULCOM	Pink	Black	5
B25	50	+24v	Pink	Red	5

Accessories, continued

NOTE: These parts available for sale to North American locations only

L7C/L7P/iX7NH System Motor Encoder Cables

Part Number	Price	Flex Rated	Length	Gauge	Drawing	Compatible Motors
APCS-EN03ES-AD	\$48.00	N	3m [9.8 ft]	24AWG	PDF	APMC motors with 17-bit incremental encoders (AYK/AYK2 motors)
APCS-EN05ES-AD	\$58.00		5m [16.4 ft]		PDF	
APCS-EN10ES-AD	\$67.00		10m [32.8 ft]		PDF	
APCS-EN20ES-AD	\$79.00		20m [65.6 ft]		PDF	
APCS-EF03ES-AD	\$70.00	Y	3m [9.8 ft]		PDF	
APCS-EF05ES-AD	\$83.00		5m [16.4 ft]		PDF	
APCS-EF10ES-AD	\$116.00		10m [32.8 ft]		PDF	
APCS-EF20ES-AD	\$188.00		20m [65.6 ft]		PDF	
APCS-EN03ES1-AD	\$79.00	N	3m [9.8 ft]	24AWG	PDF	FBL/FCL series motors with 19-bit encoders
APCS-EN05ES1-AD	\$83.00		5m [16.4 ft]		PDF	
APCS-EN10ES1-AD	\$96.00		10m [32.8 ft]		PDF	
APCS-EN20ES1-AD	\$120.00		20m [65.6 ft]		PDF	
APCS-EF03ES1-AD	\$99.00	Y	3m [9.8 ft]		PDF	
APCS-EF05ES1-AD	\$117.00		5m [16.4 ft]		PDF	
APCS-EF10ES1-AD	\$159.00		10m [32.8 ft]		PDF	
APCS-EF20ES1-AD	\$244.00		20m [65.6 ft]		PDF	
APCS-EN03DS1-AD	\$83.00	N	3m [9.8 ft]	24AWG	PDF	APM-FE/APM-FF series motors
APCS-EN05DS1-AD	\$88.00		5m [16.4 ft]		PDF	
APCS-EN10DS1-AD	\$99.00		10m [32.8 ft]		PDF	
APCS-EN20DS1-AD	\$123.00		20m [65.6 ft]		PDF	
APCS-EF03DS1-AD	\$104.00	Y	3m [9.8 ft]		PDF	
APCS-EF05DS1-AD	\$120.00		5m [16.4 ft]		PDF	
APCS-EF10DS1-AD	\$159.00		10m [32.8 ft]		PDF	
APCS-EF20DS1-AD	\$246.00		20m [65.6 ft]		PDF	



APCS-EN series encoder cable



APCS-ENxxxES1 series encoder cable



APC-EF00BS-AD

L7P/iX7NH System Encoder Accessories

Part Number	Price	Description	Compatible Drives
APC-EF00BS-AD	\$20.00	17-pin motor encoder connector.	APM-FE and APM-FF series motors
APCS-BATT36-AD	\$36.00	Encoder battery. One (1) AA ER6V lithium battery with extended leads and an encoder cable connector.	All LS Electric motors with 19-bit encoders



APCS-BATT36-AD

Accessories, *continued*

NOTE: These parts available for sale to North American locations only

L7C/L7P/iX7NH System Motor Brake Power Cables

Part Number	Price	Flex Rated	Length	Gauge	Drawing	Compatible Motors
<u>APCS-BN03QS-AD</u>	\$52.00	N	3m [9.8 ft]	18AWG	<u>PDF</u>	APMC FBL/FCL brake motors (100W – 1kW)
<u>APCS-BN05QS-AD</u>	\$55.00		5m [16.4 ft]		<u>PDF</u>	
<u>APCS-BN10QS-AD</u>	\$61.00		10m [32.8 ft]		<u>PDF</u>	
<u>APCS-BN20QS-AD</u>	\$74.00		20m [65.6 ft]		<u>PDF</u>	
<u>APCS-BF03QS-AD</u>	\$58.00	Y	3m [9.8 ft]		<u>PDF</u>	
<u>APCS-BF05QS-AD</u>	\$63.00		5m [16.4 ft]		<u>PDF</u>	
<u>APCS-BF10QS-AD</u>	\$79.00		10m [32.8 ft]		<u>PDF</u>	
<u>APCS-BF20QS-AD</u>	\$108.00		20m [65.6 ft]		<u>PDF</u>	



APCS-BN series brake cable

LS ELECTRIC L7C Series AC Servo Systems

Accessories, *continued*

NOTE: These parts available for sale to North American locations only

L7C System Motor Power Cables

Part Number	Price	Flex Rated	Length	Gauge	Drawing	Compatible Motors
APCS-PN03LSC-AD	\$40.00	N	3m [9.8 ft]	18AWG	PDF	APMC FBL/FCL motors (100W – 1kW) used with L7C drives
APCS-PN05LSC-AD	\$48.00		5m [16.4 ft]		PDF	
APCS-PN10LSC-AD	\$62.00		10m [32.8 ft]		PDF	
APCS-PN20LSC-AD	\$85.00		20m [65.6 ft]		PDF	
APCS-PF03LSC-AD	\$52.00	Y	3m [9.8 ft]		PDF	
APCS-PF05LSC-AD	\$68.00		5m [16.4 ft]		PDF	
APCS-PF10LSC-AD	\$96.00		10m [32.8 ft]		PDF	
APCS-PF20LSC-AD	\$151.00		20m [65.6 ft]		PDF	



APCS-PN series motor cable

Accessories, continued

LS Drive System Replacement Connectors

Part Number	Price	Description	Compatible Drives	Image
<u>5452573</u>	\$6.50	AutomationDirect replacement drive power connector.	All L7C drives	
<u>APC-CN1NNA-AD</u>	\$17.50	LS solder-type CN1 50-pin Electric I/O connector.	All L7C and L7P series drives	
<u>APC-CN2NNA-AD</u>	\$15.00	LS Electric I/O connector, replacement, 20-pin.	All iX7NH series drives	
<u>APC-CN3NNA-AD</u>	\$17.50	LS Electric solder-type CN2 14-pin drive encoder connector.	All L7C, L7P, and iX7NH series drives	
<u>APCS-CN6K-AD</u>	\$19.00	LS Electric STO connector, replacement, 6-pin. For use with all LS Electric iX7 series drives.	All iX7NH series drives	
<u>IX7-CON-A</u>	\$19.00	AutomationDirect drive power connector, replacement, 11-pin. Note: Do not wire to pin 4 (the "N" terminal).	iX7NH series drives, 400W, 750W, and 1kW	
<u>IX7-CON-B</u>	\$19.00	AutomationDirect drive power connector for motor power, replacement, 4-pin.	iX7NH series drives, 400W, 750W, and 1kW	
<u>IX7-CON-C</u>	\$9.00	AutomationDirect drive power connector release, replacement.	iX7NH series drives, 400W, 750W, and 1kW	
<u>IX7-CON-D</u>	\$19.00	AutomationDirect drive power connector for motor power, replacement, 4-pin	iX7NH series drives, 2kW and 3.5 kW	
<u>IX7-CON-E</u>	\$19.00	AutomationDirect drive control power connector, replacement, 5-pin.	iX7NH series drives, 2kW and 3.5 kW	
<u>IX7-CON-F</u>	\$19.00	AutomationDirect drive main power connector, replacement, 6-pin.	iX7NH series drives, 2kW and 3.5 kW	
<u>L7P-CON-A</u>	\$15.00	Replacement 11-pin drive power connector. Do not wire to pin 4 (the "N" terminal)	L7PA series 230VAC 400W and 1kW drives	
<u>L7P-CON-B</u>	\$8.00	Replacement 3-pin drive power connector.	L7PA series 230VAC 400W and 1kW drives	

Continued on next page

Accessories, continued

L7C/L7P/iX7NH System Braking Resistors

Use external braking resistors to provide additional regenerative capacity and to dissipate heat away from the servo drive.

Part Number	Price	Description	Drawing	Compatible Drive Series	Compatible Drive Models
<u>APCS-140R50-AD</u>	\$18.50	LS Electric 140W 30Ω encapsulated braking resistor	<u>PDF</u>	All 400W LS drives	L7CA004U-AD L7PA004U-AD IX7NHA004U-AD
<u>APCS-300R30-AD</u>	\$24.00	LS Electric 300W 30Ω encapsulated braking resistor	<u>PDF</u>	All 230VAC 750W and 1kW LS drives	L7CA010U-AD L7PA010U-AD IX7NHA008U-AD IX7NHA010U-AD
<u>APC-600R30-AD</u>	\$42.00	LS Electric 600W 30Ω encapsulated braking resistor.	<u>PDF</u>	All 230VAC 2.2 kW and 3.5 kW LS drives	L7PA020U-AD L7PA035U-AD IX7NHA020U-AD IX7NHA035U-AD
<u>APC-600R28-AD</u>	\$64.00	LS Electric 600W 28Ω encapsulated braking resistor.	<u>PDF</u>	All 230VAC 5.5 kW and 7.5 kW LS drives	L7PA050U-AD L7PA075U-AD
<u>APCS-300R82-AD</u>	\$16.00	LS Electric 300W 82Ω encapsulated braking resistor.	<u>PDF</u>	All 460VAC 1kW LS drives	L7PB010U-AD
<u>APCS-600R140-AD</u>	\$42.00	LS Electric 600W 140Ω encapsulated braking resistor.	<u>PDF</u>	Alternate resistor for 460VAC 2.2 kW and 3.5 kW LS drives	Alternate resistor for L7PB020U-AD L7PB035U-AD
<u>APCS-600R75-AD</u>	\$42.00	LS Electric 600W 75Ω encapsulated braking resistor.	<u>PDF</u>	All 460VAC 2.2, 3.5, 5.5, and 7.5 kW LS drives	L7PB020U-AD L7PB035U-AD L7PB050U-AD L7PB075U-AD



NOTE: 600W resistors require customer-supplied M5-.8 bolts and cable lugs for connection.



APCS-140R50-AD

Accessories, continued

NOTE: These parts available for sale to North American locations only

L7C/L7P/iX7NH/PHOX System Planetary Gearboxes

Precision planetary gearboxes can increase the torque output of servo systems while reducing the reflected load inertia for higher response. Gearboxes offer high stiffness, high efficiency, and very quiet operation. Input motor shaft clamp, oversized output shaft key, and mounting hardware are included for mating to LS Electric motors.

Features:

- Maintenance free (no need to replace lubrication)
- IP65
- Operating temperature range of -10°C to +90°C [14°F to 194°F]
- Uses VIGO Grease RE #0



MSS Series Planetary Gearbox

MSS Series Planetary Gearbox Specifications										
Model	96200004	96200005	96200103	96200007	96200008	96200257	96200373	96200378	96200393	96200459
Manufacturer Part Number	MSS0601A-005KS-B3110103C14	MSS0601A-010KS-B3110103C14	MSS0902B-020KS-B3110103C14	MSS0901A-005KS-C3110103C19	MSS0901A-010KS-C3110103C19	MSS1152B-020KS-C4120103C19	MSS0901A-005KS-C4120103C19	MSS0901A-010KS-C4120103C19	MSS1152B-020KS-C4120103C19	MSS1151A-005KS-D3110103C22
Compatible Motors	APMC-FBL series 100, 200, 300, and 400 W motors			APMC FCL series 750W and 1kW motors			APM-FE series 900W and 1.5 kW motors			APM-FE series 1.6 kW motors
Price	\$288.00	\$296.00	\$528.00	\$387.00	\$387.00	\$762.00	\$350.00	\$350.00	\$699.00	\$499.00
Drawing	PDF	PDF	PDF	PDF	PDF	PDF	PDF	PDF	PDF	PDF
Ratio	5:1	10:1	20:1	5:1	10:1	20:1	5:1	10:1	20:1	5:1
Nominal Output Torque	54 N·m	42 N·m	143 N·m	160 N·m	121 N·m	295 N·m	160 N·m	121 N·m	295 N·m	332 N·m
Inertia	0.13 kg/cm ²	0.13 kg/cm ²	0.13 kg/cm ²	0.48 kg/cm ²	0.44 kg/cm ²	0.48 kg/cm ²	0.48 kg/cm ²	0.44 kg/cm ²	0.48 kg/cm ²	2.81 kg/cm ²
Output Shaft Diameter	16mm	16mm	22mm	22mm	22mm	32mm	22mm	22mm	32mm	32mm
Stage	1	1	2	1	1	2	1	1	2	1
Frame	60mm	60mm	90mm	90mm	90mm	115mm	90mm	90mm	115mm	115mm
Nominal Input Speed (rpm)	5,000	5,000	4,000	4,000	4,000	4,000	4,000	4,000	4,000	4,000
Max Input Speed (rpm)	10,000	10,000	8,000	8,000	8,000	8,000	8,000	8,000	8,000	8,000
Emergency Stop Torque	3 times nominal output torque									
Noise (dB)	≤54	≤54	≤56	≤56	≤56	≤59	≤56	≤56	≤59	≤59
Efficiency (%)	≥97	≥97	≥94	≥97	≥97	≥94	≥97	≥97	≥94	≥97
Backlash (Arcmin)	≤7	≤7	≤9	≤7	≤7	≤9	≤7	≤7	≤9	≤7
Max Radial Load (N)	1,280	1,280	3,200	3,200	3,200	6,800	3,200	3,200	6,800	6,800
Max Axial Load (N)	690	690	1,600	1,600	1,600	3,400	1,600	1,600	3,400	3,400
Service Life (Hours)	20,000 (10,000 under continuous operation)									
Continued on next page										



LS Electric AC Servo Systems

Accessories, continued

MSS Series Planetary Gearbox Specifications											
Model	96200464	96200479	96200010	96200011	96200445	96200013	96200014	96200701	96200016	96200017	96200862
Manufacturer Part Number	MSS1151A-010KS-D3110103C22	MSS1422B-020KS-D3110103C22	MSS1151A-005KS-D3110103C24	MSS1151A-010KS-D3110103C24	MSS1422B-020KS-D3110103C24	MSS1421A-005KS-E3110103C35	MSS1421A-010KS-E3110103C35	MSS1802B-020KS-E3110103C35	MSS1801A-005KS-F3110103C42	MSS1801A-010KS-F3110103C42	MSS1802A-015KS-F3110103C42
Compatible Motors	APM-FE series 1.6 kW motors		APM-FE series 2.2 kW motors			APM-FF series 3.5 kW and 5.5 kW motors			APM-FF series 7.5 kW motors		
Price	\$499.00	\$1,030.00	\$499.00	\$499.00	\$1,030.00	\$770.00	\$770.00	\$1,850.00	\$1,480.00	\$1,480.00	\$1,850.00
Drawing	PDF	PDF	PDF	PDF	PDF	PDF	PDF	PDF	PDF	PDF	PDF
Ratio	10:1	20:1	5:1	10:1	20:1	5:1	10:1	20:1	5:1	10:1	15:1
Nominal Output Torque	262 N·m	295 N·m	332 N·m	262 N·m	295 N·m	634 N·m	500 N·m	1060 N·m	1195 N·m	960 N·m	897 N·m
Inertia	2.59 kg/cm ²	2.81 kg/cm ²	2.81 kg/cm ²	2.59 kg/cm ²	2.81 kg/cm ²	7.52 kg/cm ²	7.05 kg/cm ²	7.52 kg/cm ²	24.29 kg/cm ²	23.51 kg/cm ²	24.29 kg/cm ²
Output Shaft Diameter	32mm	40mm	32mm	32mm	40mm	40mm	40mm	55mm	55mm	55mm	55mm
Stage	1	2	1	1	2	1	1	2	1	1	2
Frame	115mm	142mm	115mm	115mm	142mm	142mm	142mm	180mm	180mm	180mm	180mm
Nominal Input Speed (rpm)	4,000	3,000	4,000	4,000	3,000	3,000	3,000	3,000	3,000	3,000	3,000
Max Input Speed (rpm)	8,000	6,000	8,000	8,000	6,000	6,000	6,000	6,000	6,000	6,000	6,000
Emergency Stop Torque	3 times nominal output torque										
Noise (dB)	≤59	≤62	≤59	≤59	≤62	≤62	≤62	≤64	≤64	≤64	≤64
Efficiency (%)	≥97	≥94	≥97	≥97	≥94	≥97	≥97	≥94	≥97	≥97	≥94
Backlash (Arcmin)	≤7	≤9	≤7	≤7	≤9	≤7	≤7	≤9	≤7	≤7	≤9
Max Radial Load (N)	6,800	9,300	6,800	6,800	9,300	9,300	9,300	15,100	15,100	15,100	15,100
Max Axial Load (N)	3,400	4,500	3,400	3,400	4,500	4,500	4,500	7,500	7,500	7,500	7,500
Service Life (Hours)	20,000 (10,000 under continuous operation)										