

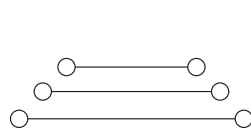

Triple-Level Terminal Blocks

- Designed to make sensor connections more practical
- Ideal for individual cross connections for each layer
- Screw connection terminal
- UL E179129 (For copper wire only. One conductor in terminal only.)
- CE (EN 60947-7-1)



KN-TL14

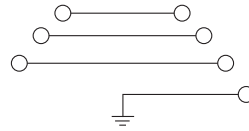
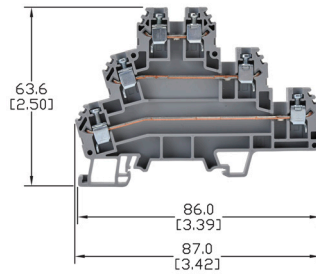

KN-TG12

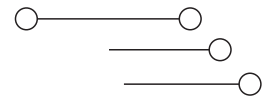
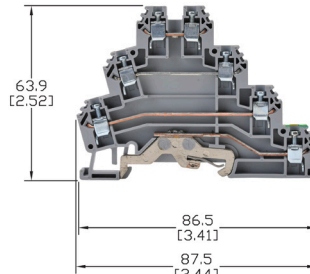

KN-TL14S

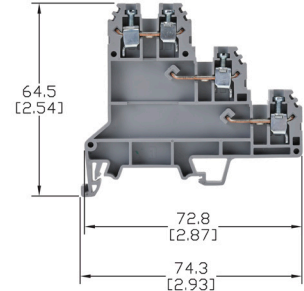

See our website: www.AutomationDirect.com for complete engineering drawings

Ordering Information									
Color	Part Number	Qty	Price	Part Number	Qty	Price	Part Number	Qty	Price
Gray	KN-TL14	20	\$40.50	KN-TG12	20	\$108.00	KN-TL14S	20	\$36.50

Technical Specifications									
Model	KN-TL14			KN-TG12			KN-TL14S		
Width	6mm [0.24 in]			6mm [0.24 in]			6mm [0.24 in]		
Striping Length	8mm [0.31 in]			8mm [0.31 in]			8mm [0.31 in]		
Tightening Torque	0.4 N·m [3.5 lb-in]			0.4 N·m [3.5 lb-in]			0.5 N·m [4.4 lb-in]		
Density	166/m [50 pcs/ft]			166/m [50 pcs/ft]			166/m [50 pcs/ft]		
UL/CSA Approval	300V	24A	24-12 AWG	300V	24A	24-12 AWG	300V	24A	24-12 AWG
CE Conformity	440V	24A	2.5 mm ²	440V	24A	2.5 mm ²	550V	24A	2.5 mm ²
SCCR Rating	100kA			100kA			100kA per Table SB4.1, 2009, UL 508A.		
Operating Temperature	Ambient air temperature: -67 to 185°F [-55 to 85°C] Relative humidity: 50% max at 104°F [40°C] and 90% max at 68°F [20°C]								
Material	Current Bar: Copper Alloy / Housing: Polyamide 66 / Screws: Zinc Plated Steel								
DIN Rail Width	35mm								

Accessories										
End Cover	Gray	KN-ECTL	10/pkg	\$3.75	KN-ECTG12	10/pkg	\$4.75	KN-ECTLS	10/pkg	\$4.75
Jumpers	2-pole	KN-2JTL12	25/pkg	\$18.50	KN-2JTL12	25/pkg	\$18.50	KN-2JTL12	25/pkg	\$18.50
	3-pole	KN-3JTL12	20/pkg	\$23.00	KN-3JTL12	20/pkg	\$23.00	KN-3JTL12	20/pkg	\$23.00
	4-pole	KN-4JTL12	15/pkg	\$21.50	KN-4JTL12	15/pkg	\$21.50	KN-4JTL12	15/pkg	\$21.50
	10-pole	KN-10JTL12	5/pkg	\$18.50	KN-10JTL12	5/pkg	\$18.50	KN-10JTL12	5/pkg	\$18.50
Marking Tags	KN-L5 Series			KN-L5 Series			KN-L5 Series			



Triple-Level Terminal Blocks

Sensor Terminal Blocks with LED

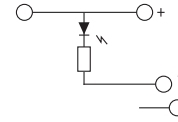
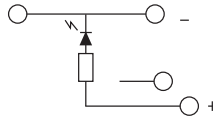

Dimensions: mm [in]

KN-TL14SLN (for NPN sensors)

KN-TL14SLP (for PNP sensors)

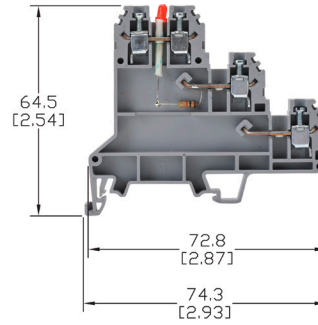
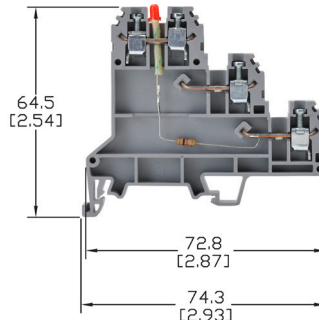

- Make sensor connections more practical
- Provide individual cross connections for each layer
- Screw connection terminal
- UL E179129 (For copper wire only. One conductor in terminal only.)
- CE (EN 60947-7-1/ EN 60947-7-2)

See our website: www.AutomationDirect.com for complete engineering drawings

Ordering Information						
Color	Part Number	Qty	Price	Part Number	Qty	Price
Gray	KN-TL14SLN	20	\$67.00	KN-TL14SLP	20	\$67.00

Technical Specifications						
Model	KN-TL14SLN			KN-TL14SLP		
Width	6mm [0.24 in]			6mm [0.24 in]		
Stripping Length	8mm [0.31 in]			8mm [0.31 in]		
Tightening Torque	0.5 N·m [4.4 lb-in]			0.5 N·m [4.4 lb-in]		
Density	166/m [50 pcs/ft]			166/m [50 pcs/ft]		
UL/CSA Approval	300V	24A	24-12 AWG	300V	24A	24-12 AWG
CE Conformity	—	24A	2.5 mm ²	—	24A	2.5 mm ²
LED Voltage	2 Volts			2 Volts		
Resistor Value	10kΩ			10kΩ		
SCCR Rating	100kA per Table SB4.1, 2009, UL 508A. Maximum short circuit current rating for unmarked components.					
Operating Temperature	Ambient air temperature: -67 to 185°F [-55 to 85°C] Relative humidity: 50% max at 104°F [40°C] and 90% max at 68°F [20°C]					
Material	Current Bar: Copper Alloy / Housing: Polyamide 66 / Screws: Zinc Plated Steel					
DIN Rail Width	35mm					

Accessories							
End Covers	Gray	KN-ECTLS	10/pkg	\$4.75	KN-ECTLS	10/pkg	\$4.75
Jumpers	2-pole	KN-2JTL12	25/pkg	\$18.50	KN-2JTL12	25/pkg	\$18.50
	3-pole	KN-3JTL12	20/pkg	\$23.00	KN-3JTL12	20/pkg	\$23.00
	4-pole	KN-4JTL12	15/pkg	\$21.50	KN-4JTL12	15/pkg	\$21.50
	10-pole	KN-10JTL12	5/pkg	\$18.50	KN-10JTL12	5/pkg	\$18.50
Marking Tags	KN-L5 Series				KN-L5 Series		



100kA Terminal Block Short-Circuit Current Rating Data

Short-Circuit Current Rating Data										
Part Number	Suitable Copper Conductor Range (AWG)		Fuse Class Maximum Amperage						SCCR Rating	Volts Max
	Line	Load	Class J	Class T	Class RK1	Class RK5	Class G	Class CC		
KN-T12 ²	26-12	26-12	20	20	—	—	20	20	100 kA	600
KN-T10 ²	26-10	26-10	30	30	—	—	30	30	100 kA	600
KN-T8 ²	26-8	26-8	50	50	30	—	45	30	100 kA	600
KN-T6 ²	16-6	16-6	80	80	60	30	60	30	100 kA	600
KN-T4 ²	12-4	12-4	80	80	60	30	60	30	100 kA	600
KN-T2 ²	12-2	12-2	125	125	100	30	60	30	100 kA	600
KN-T1/0 ³	6-1/0	6-1/0	150	150	100	30	60	30	100 kA	600
KN-T2/0 ³	6-2/0	6-2/0	225	225	100	60	60	30	100 kA	600
KN-D12 ^{1 2}	26-12	26-12	20	20	—	—	20	20	100 kA	600
KN-D10 ^{1 2}	26-10	26-10	30	30	—	—	30	30	100 kA	600
KN-TL14 ²	24-12	24-12	30	30	—	—	30	30	100 kA	600
KN-TG12 ²	24-12	24-12	30	30	—	—	30	30	100 kA	600
KN-M12 ²	26-12	26-12	30	30	—	—	30	30	100 kA	600
KN-M10 ²	14-12	14-12	30	30	—	—	30	30	100 kA	600

Note: ¹ KN-D12 and KN-D10 have optional short circuit rating evaluated for use with copper conductors only. Must be protected by the max ampere and Class of overcurrent protective device noted above.

²The terminal block short-circuit rating for KN-D12 and KN-D10 were determined based on testing in a minimum size enclosure measuring 4x4x6 inches. The suitability of smaller enclosures shall be determined in the end-use investigation.

³The terminal block short-circuit rating for KN-T1/0 and KN-T2/0 were determined based on testing in a minimum size enclosure measuring 12x12x6 inches. The suitability of smaller enclosures shall be determined in the end-use investigation.



KONNECT-IT Accessories

Multi-Pole Jumper Bars

Multi-pole jumper bars provide terminal block connection flexibility. Screw-down connection jumpers feature all-metal construction and can be installed quickly just by tightening the screws. Screwless comb-style jumpers are also available. See next page for the larger J1/0 jumper installation instructions.

KN-10J12



KN-2JM12



KN-2JCC8



Multi-Pole Jumper Bars Ordering Information

Type	Part Number	Price	Qty	Number of Poles	Rating		Tightening Torque	Dimensions - mm [in]			Fig.	Works With
					(V)	(A)		Height	Length	Width		
Screw-down connection	KN-2J12	\$12.00	25	2	750	24	0.4–0.6 Nm [3.5–5.3 lb-in]	15.8 [0.62]	10.1 [0.40]	4.4 [0.17]	1	KN-T12xx KN-D12xx KN-D12X KN-D12DR1 KN-D12LEDxx
	KN-3J12	\$14.50	20	3	750	24			15.3 [0.60]			
	KN-4J12	\$18.00	15	4	750	24			20.4 [0.80]			
	KN-10J12	\$12.00	5	10	750	24			51.1 [2.01]			
	KN-2J10	\$17.00	25	2	750	32	0.6–0.8 Nm [5.3–7.1 lb-In]	15.5 [0.61]	10.8 [0.43]	6.0 [0.24]	1	KN-T10xx KN-D10xx KN-D10X KN-D10DR1 KN-D10LEDxx
	KN-3J10	\$20.50	20	3	750	32			17.0 [0.67]			
	KN-4J10	\$20.50	15	4	750	32			23.0 [0.91]			
	KN-10J10	\$14.50	5	10	750	32			59.0 [2.32]			
	KN-2J8	\$18.00	25	2	630	41	0.6–0.8 Nm [5.3–7.1 lb-In]	15.5 [0.61]	14.3 [0.56]	6.0 [0.24]	1	KN-T8xx
	KN-3J8	\$22.00	20	3	630	41			22.3 [0.88]			
	KN-4J8	\$21.50	15	4	630	41			30.3 [1.19]			
	KN-10J8	\$17.00	5	10	630	41			78.3 [3.08]			
	KN-2J6	\$22.50	25	2	630	57	0.6–0.8 Nm [5.3–7.1 lb-In]	15.5 [0.61]	18.0 [0.71]	6.0 [0.24]	1	KN-T6xx
	KN-3J6	\$23.50	20	3	630	57			28.0 [1.10]			
	KN-4J6	\$23.50	15	4	630	57			38.0 [1.50]			
	KN-10J6	\$18.50	5	10	630	57			98.0 [3.86]			
	KN-2J4	\$35.50	25	2	750	76	0.6–0.8 Nm [5.3–7.1 lb-In]	23.0 [0.91]	21.0 [0.83]	6.0 [0.24]	1	KN-T4xx
	KN-3J4	\$37.00	20	3	750	76			33.0 [1.30]			
	KN-4J4	\$37.00	15	4	750	76			45.0 [1.77]			
	KN-10J4	\$29.50	5	10	750	76			117.0 [4.61]			
KN-2J2	\$36.00	25	2	750	125	1.2–1.4 Nm [10.6–12.4 lb-In]	21.0 [0.83]	29.0 [1.14]	8.0 [0.31]	1	KN-T2xx	
KN-3J2	\$39.00	20	3	750	125			45.0 [1.77]				
KN-4J2	\$39.00	15	4	750	125			61.0 [2.40]				
KN-10J2	\$29.50	5	10	750	125			157.0 [6.18]				
KN-2J1/0	\$11.00	5	2	1000	150	2.5–3.5 Nm [22.1–31.0 lb-In]	22.3 [0.88]	36.0 [1.42]	12.0 [0.47]	2	KN-T1/0xx	
KN-3J1/0	\$18.50	5	3	1000	150			56.0 [2.20]				
KN-4J1/0	\$23.50	5	4	1000	150			76.0 [2.99]				
KN-2JTL12	\$18.50	25	2	440	24	0.4–0.6 Nm [3.5–5.3 lb-In]	15.5 [0.61]	11.0 [0.43]	4.4 [0.17]	1	KN-DG12 KN-TG12 KN-TL14 KN-TL14S KN-TL14SLN KN-TL14SLP	
KN-3JTL12	\$23.00	20	3	440	24			17.0 [0.67]				
KN-4JTL12	\$21.50	15	4	440	24			23.0 [0.91]				
KN-10JTL12	\$18.50	5	10	440	24			59.0 [2.32]				
Push-in Connection	KN-2JM10	\$11.00	25	2	750	32	-	23.2 [0.91]	9.5 [0.37]	2.7 [0.11]	3	KN-M10xx KN-KBD10
	KN-3JM10	\$13.50	20	3	750	32			15.5 [0.61]			
	KN-4JM10	\$15.50	15	4	750	32			21.5 [0.85]			
	KN-10JM10	\$14.50	5	10	750	32	57.5 [2.26]					
	KN-2JM12	\$10.50	25	2	750	24	-	21.7 [0.85]	8.0 [0.31]	2.3 [0.09]	3	KN-M12xx KN-T12SP4
	KN-3JM12	\$12.00	20	3	750	24			13.0 [0.51]			
	KN-4JM12	\$12.00	15	4	750	24			18.0 [0.71]			
KN-10JM12	\$13.50	5	10	750	24	48.0 [1.89]						
Screwless Comb-style	KN-2JCC12	\$15.50	25	2	750	24	-	23.7 [0.93]	8.0 [0.31]	2.8 [0.11]	4	KN-T12xx
	KN-2JCC10	\$31.00	25		750	32	-	24.7 [0.97]	9.5 [0.37]			KN-T10xx
	KN-2JCC8	\$32.50	25		630	41	-	25.6 [1.01]	13.5 [0.53]			KN-T8xx
	KN-2JCC6	\$36.00	25		630	57	-	26.7 [1.05]	16.0 [0.63]			KN-T6xx

Figure 1

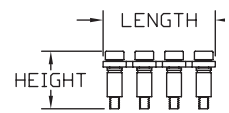

Figure 2

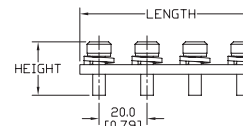

Figure 3

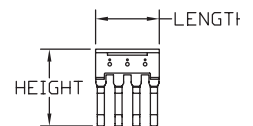
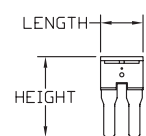

Figure 4



Please visit our website www.AutomationDirect.com for complete engineering drawings.



KONNECT-IT Accessories

End Brackets

End brackets prevent terminal blocks and other DIN rail mount components and devices from moving laterally on the rail. They are constructed from polyamide 66 and available in configurations for 35mm and 15mm DIN rails.

Dimensions mm [in]

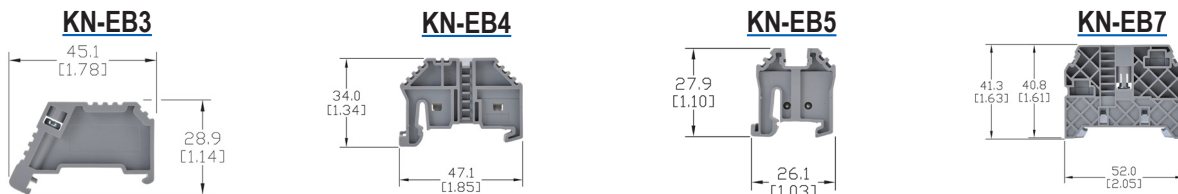

End Brackets Ordering Information												
Gray End Brackets	KN-EB3	100/pkg	\$48.00	KN-EB4	100/pkg	\$50.00	KN-EB5	100/pkg	\$73.00	KN-EB7	50/pkg	\$50.00
	KN-EB3-10	10/pkg	\$6.00	KN-EB4-10	10/pkg	\$4.75	KN-EB5-10	10/pkg	\$8.50	KN-EB7-10	10/pkg	\$9.75
Technical Specifications												
Description	Screw-type end bracket			Screwless end bracket			Screwless end bracket			Screw-type end bracket		
Bracket Width	8 mm [0.31 in]			8 mm [0.31 in]			8 mm [0.31 in]			10 mm [0.39 in]		
DIN Rail Width	35 mm			35 mm			15 mm			35 mm		
Material	Housing: Polyamide 66 / Clamping Connector: Zinc Plated Steel											
End Bracket Accessories												
Label Holder	—	—	—	KN-MA-1	25/pkg	\$21.50	—	—	—	KN-MA-2	50/pkg	\$54.00
	—	—	—	KN-MA-1-10	10/pkg	\$9.75	—	—	—	KN-MA-2-10	10/pkg	\$12.50
Marking Tags	KN-L5 Series or KN-L6P5 Series											

End Covers

End covers are used to cover the open side of sectional DIN rail mount terminal blocks. They should be used at the end of an assembly of identical terminal blocks or whenever there is a change in the physical size of the terminal block.

Material: Polyamide 66

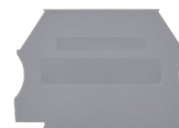

End Covers Ordering Information													
Part Number	Color	Dimensions H x L x W mm [in]	Works With	Qty	Price	Part Number	Color	Dimensions H x L x W mm [in]	Works With	Qty	Price		
KN-ECT6GRY	gray	34.0x42.7x1.3 [1.34x1.68x0.05]	KN-T12 KN-T10 KN-T8 KN-T6	100	\$26.50	KN-ECDORG	orange	48.2x63.2x1.3 [1.90x2.49x0.05]	KN-D10 KN-D12	10	\$6.00		
KN-ECT6GRY-25	gray			KN-ECDRED	red	25	\$6.00						
KN-ECT6BLU	blue			KN-ECDYEL	yellow		\$3.00						
KN-ECT6BLK	black						\$3.00	KN-ECTL	gray	54.7x87.1x1.3 [2.15x3.43x0.05]	KN-TL14	10	\$3.75
KN-ECT6BRN	brown						\$3.00	KN-ECTLS	gray	54.7x72.8x1.2 [2.15x2.87x0.05]	KN-TL14S	10	\$4.75
KN-ECT6GRN	green						\$3.00	KN-ECDG12	gray	48.0x71.4x1.2 [1.89x2.81x0.05]	KN-DG12	10	\$4.75
KN-ECT6ORG	orange						\$3.00	KN-ECTG12	gray	62.5x87.5x1.2 [2.46x3.44x0.05]	KN-TG12	10	\$4.75
KN-ECT6RED	red						\$3.00	KN-ECMGRY	gray	28.1x27.0x3.0 [1.11x1.06x0.12]	KN-M12 KN-M10	100	\$55.00
KN-ECT6WHT	white						\$3.00	KN-ECMGRY-10	gray			10	\$6.00
KN-ECT6YEL	yellow						\$3.00	KN-ECMBLU	blue			10	\$6.00
KN-ECT4GRY	gray	45.7x52.8x1.2 [1.80x2.08x0.05]	KN-T4	25	\$12.50	KN-ECMGRN	green/ yellow	28.1x27.0x3.0 [1.11x1.06x0.12]	KN-MG12 KN-MG10	10	\$6.00		
KN-ECT4BLU	blue					10	\$5.25	KN-ECG12SP4	green/ yellow	39.7x57.1x1.2 [1.56x2.25x0.05]	KN-G12SP4	10	\$4.75
KN-ECDGRY	gray	48.2x63.2x1.3 [1.90x2.49x0.05]	KN-D10 KN-D12	25	\$13.50	KN-ECT12SP4	gray	39.7x57.1x1.2 [1.56x2.25x0.05]	KN-T12SP4	25	\$12.00		
KN-ECDBLU	blue					10	\$6.00	KN-ECF10	gray	27.3x59.6x1.2 [1.07x2.35x0.05]	KN-F10	25	\$14.50
KN-ECDBLK	black						\$6.00	KN-ECKBD	gray	37.1x53.5x1.2 [1.46x2.11x0.05]	KN-KDB10	10	\$6.00
KN-ECDGRN	green						\$6.00						



KONNECT-IT Accessories

Separators

Separators are used to segment banks of terminal blocks. Allows you to maintain a single row of terminal blocks, but have separate power source clusters.

Separators Ordering Information							
Part Number	Color	Works With	Dimensions - mm [in]			Qty	Price
			Height	Length	Thickness		
KN-ST1GRY	Gray	KN-T12 KN-T10 KN-T8 KN-T6	39.0 [1.54]	42.5 [1.67]	1.2 [0.05]	10	\$12.50
KN-ST1BLU	Blue						\$4.75
KN-ST1BLK	Black						\$4.75
KN-ST1BRN	Brown						\$4.75
KN-ST1GRN	Green						\$4.75
KN-ST1ORG	Orange						\$4.75
KN-ST1RED	Red						\$4.75
KN-ST1WHT	White						\$4.75
KN-ST1YEL	Yellow						\$4.75
KN-ST2GRY	Gray						KN-T4
KN-ST2BLU	Blue	\$16.00					
KN-ST3GRY	Gray	KN-T2	62.6 [2.46]	53.1 [2.09]	1.5 [0.06]	10	\$8.00
KN-ST3BLU	Blue						\$8.00

KN-ST1GRY



Top Covers and Label Holders

Top Covers and Label Holders Ordering Information							
Part Number	Description	Works With	Dimensions - mm [in]			Qty	Price
			Height	Length	Width		
KN-TC-1	Top cover for Konnect-It terminal block, blank, white	KN-T12 KN-T10 KN-T8 KN-T6	6.8 [0.27]	29.0 [1.14]	5.8 [0.23]	25	\$9.75
KN-TC-1S	Top cover for Konnect-It terminal block, printed electric symbol, white					25	\$14.00
KN-TC-2	Top cover for Konnect-It terminal block, blank, white	KN-T4 KN-T2	7.3 [0.29]	35.8 [1.41]	9.0 [0.35]	25	\$25.00
KN-TC-2S	Top cover for Konnect-It terminal block, printed electric symbol, white					25	\$25.00
KN-MA-1	Label holder for terminal block group. Label media not included. Adhesive label: Apply on top.	KN-EB4	46.2 [1.82]	46.0 [1.81]	11.4 [0.45]	25	\$21.50
KN-MA-1-10	Max label dimensions: 7 x 44 mm (0.28 x 1.73 in).					10	\$9.75
KN-MA-2	Label holder for terminal block group. Label media not included. Adhesive label: Apply on top.	KN-EB7	37.5 [1.48]	46.2 [1.82]	9.5 [0.37]	50	\$54.00
KN-MA-2-10	Max label dimensions: 7 x 44 mm (0.28 x 1.73 in).					10	\$12.50
KN-MA-3	Top mounting marking tag adapter for terminal block. Holds up to (4) L5x5 tags	KN-T4 KN-T2	9.3 [0.36]	36.0 [1.42]	9.0 [0.35]	25	\$14.00
KN-MA-4	Top mounting marking tag adapter for terminal block. Holds up to (4) L5x5 tags	KN-T12 KN-T10 KN-T8 KN-T6	9.0 [0.35]	29.0 [1.14]	5.7 [0.22]	25	\$12.50
KN-MA-5	Label holder for terminal block group. Label media included.	Attaches to any 35mm DIN rail	46.4 [1.83]	44.5 [1.75]	10.0 [0.39]	50	\$44.00
KN-MA-5-25	Max label dimensions: 10 x 38mm (0.39 x 1.50 in). Thickness 0.30 mm (0.01 in)					25	\$27.00

KN-MA-1



KN-MA-2



KN-MA-5



KN-TC-1 / KN-TC-2



KN-TC-1S / KN-TC-2S



KN-MA-3



KN-MA-4





KONNECT-IT Accessories

Marking Tags 5 x 5mm

Use with any KONNECT-IT series terminal blocks.



5 x 5mm Marking Tags Ordering Information											
250 Pieces per Package						500 Pieces per Package					
Part Number	Imprint	Price	Part Number	Imprint	Price	Part Number	Imprint	Price	Part Number	Imprint	Price
KN-L5-BLANK-250	Blank	\$11.50	KN-L5-A-250	A	\$11.50	KN-L5-BLANK	Blank	\$18.00	KN-L5-A	A	\$22.00
KN-L5-0-250	0	\$11.50	KN-L5-B-250	B	\$11.50	KN-L5-0	0	\$22.00	KN-L5-B	B	\$22.00
KN-L5-1-250	1	\$11.50	KN-L5-C-250	C	\$11.50	KN-L5-1	1	\$22.00	KN-L5-C	C	\$22.00
KN-L5-2-250	2	\$11.50	KN-L5-D-250	D	\$11.50	KN-L5-2	2	\$22.00	KN-L5-D	D	\$22.00
KN-L5-3-250	3	\$11.50	KN-L5-E-250	E	\$11.50	KN-L5-3	3	\$22.00	KN-L5-E	E	\$22.00
KN-L5-4-250	4	\$11.50	KN-L5-F-250	F	\$11.50	KN-L5-4	4	\$22.00	KN-L5-F	F	\$22.00
KN-L5-5-250	5	\$11.50	KN-L5-G-250	G	\$11.50	KN-L5-5	5	\$22.00	KN-L5-G	G	\$22.00
KN-L5-6-250	6	\$11.50	KN-L5-H-250	H	\$11.50	KN-L5-6	6	\$22.00	KN-L5-H	H	\$22.00
KN-L5-7-250	7	\$11.50	KN-L5-I-250	I	\$11.50	KN-L5-7	7	\$22.00	KN-L5-I	I	\$22.00
KN-L5-8-250	8	\$11.50	KN-L5-J-250	J	\$12.00	KN-L5-8	8	\$22.00	KN-L5-J	J	\$22.50
KN-L5-9-250	9	\$11.50	KN-L5-K-250	K	\$12.00	KN-L5-9	9	\$22.00	KN-L5-K	K	\$22.50
KN-L5-10-250	10	\$11.50	KN-L5-L-250	L	\$11.50	KN-L5-10	10	\$22.00	KN-L5-L	L	\$22.00
KN-L5-1-10-250	1-10	\$11.50	KN-L5-M-250	M	\$12.00	KN-L5-1-10	1-10	\$22.00	KN-L5-M	M	\$22.50
KN-L5-11-20-250	11-20	\$11.50	KN-L5-N-250	N	\$11.50	KN-L5-11-20	11-20	\$22.00	KN-L5-N	N	\$22.00
KN-L5-21-30-250	21-30	\$11.50	KN-L5-O-250	O	\$11.50	KN-L5-21-30	21-30	\$22.00	KN-L5-O	O	\$22.00
KN-L5-31-40-250	31-40	\$11.50	KN-L5-P-250	P	\$12.00	KN-L5-31-40	31-40	\$22.00	KN-L5-P	P	\$22.50
KN-L5-41-50-250	41-50	\$11.50	KN-L5-Q-250	Q	\$12.00	KN-L5-41-50	41-50	\$22.00	KN-L5-Q	Q	\$22.50
KN-L5-1-50-250	1-50	\$11.50	KN-L5-R-250	R	\$11.50	KN-L5-1-50	1-50	\$22.00	KN-L5-R	R	\$22.00
KN-L5-51-100-250	51-100	\$11.50	KN-L5-S-250	S	\$11.50	KN-L5-51-100	51-100	\$22.00	KN-L5-S	S	\$22.00
KN-L5-101-150-250	101-150	\$11.50	KN-L5-T-250	T	\$11.50	KN-L5-101-150	101-150	\$22.00	KN-L5-T	T	\$22.00
KN-L5-151-200-250	151-200	\$11.50	KN-L5-U-250	U	\$12.00	KN-L5-151-200	151-200	\$22.00	KN-L5-U	U	\$22.50
KN-L5-201-250-250	201-250	\$11.50	KN-L5-V-250	V	\$11.50	KN-L5-201-250	201-250	\$22.00	KN-L5-V	V	\$22.00
KN-L5-251-300-250	251-300	\$11.50	KN-L5-W-250	W	\$12.00	KN-L5-251-300	251-300	\$22.00	KN-L5-W	W	\$22.50
KN-L5-301-350-250	301-350	\$11.50	KN-L5-X-250	X	\$11.50	KN-L5-301-350	301-350	\$22.00	KN-L5-X	X	\$22.00
KN-L5-351-400-250	351-400	\$11.50	KN-L5-Y-250	Y	\$11.50	KN-L5-351-400	351-400	\$22.00	KN-L5-Y	Y	\$22.00
KN-L5-401-450-250	401-450	\$11.50	KN-L5-Z-250	Z	\$12.00	KN-L5-401-450	401-450	\$22.00	KN-L5-Z	Z	\$22.50
KN-L5-451-500-250	451-500	\$11.50	KN-L5-POS-250	+	\$11.50	KN-L5-451-500	451-500	\$22.00	KN-L5-POS	+	\$22.00
KN-L5-L1-250	L1	\$11.50	KN-L5-NEG-250	-	\$11.50	KN-L5-L1	L1	\$22.00	KN-L5-NEG	-	\$22.00
KN-L5-L2-250	L2	\$11.50	KN-L5-GND-250	GND	\$11.50	KN-L5-L2	L2	\$22.00	KN-L5-GND	GND	\$22.00
KN-L5-L3-250	L3	\$11.50				KN-L5-L3	L3	\$22.00			



KONNECT-IT Accessories

Marking Tags 6.5 x 10mm

Use with any KONNECT-IT series terminal blocks 6.5mm or wider.

6.5 x 10mm Marking Tags Ordering Information			
Part Number	Description	Qty	Price
<u>KN-L6P5-BLNK-250</u>	Blank	250	\$30.00
<u>KN-L6P5-1-10-250</u>	Numbered 1-10	250	\$31.50
<u>KN-L6P5-11-20-250</u>	Numbered 11-20	250	\$31.50
<u>KN-L6P5-21-30-250</u>	Numbered 21-30	250	\$31.50
<u>KN-L6P5-31-40-250</u>	Numbered 31-40	250	\$31.50
<u>KN-L6P5-41-50-250</u>	Numbered 41-50	250	\$31.50
<u>KN-L6P5-51-60-250</u>	Numbered 51-60	250	\$31.50
<u>KN-L6P5-61-70-250</u>	Numbered 61-70	250	\$31.50
<u>KN-L6P5-71-80-250</u>	Numbered 71-80	250	\$31.50
<u>KN-L6P5-81-90-250</u>	Numbered 81-90	250	\$32.00
<u>KN-L6P5-91-100-250</u>	Numbered 91-100	250	\$32.00
<u>KN-L6P5-BLNK</u>	Blank	500	\$56.00
<u>KN-L6P5-1-10</u>	Numbered 1-10	500	\$57.00
<u>KN-L6P5-11-20</u>	Numbered 11-20	500	\$57.00
<u>KN-L6P5-21-30</u>	Numbered 21-30	500	\$57.00
<u>KN-L6P5-31-40</u>	Numbered 31-40	500	\$57.00
<u>KN-L6P5-41-50</u>	Numbered 41-50	500	\$57.00
<u>KN-L6P5-51-60</u>	Numbered 51-60	500	\$57.00
<u>KN-L6P5-61-70</u>	Numbered 61-70	500	\$57.00
<u>KN-L6P5-71-80</u>	Numbered 71-80	500	\$57.00
<u>KN-L6P5-81-90</u>	Numbered 81-90	500	\$58.00
<u>KN-L6P5-91-100</u>	Numbered 91-100	500	\$58.00

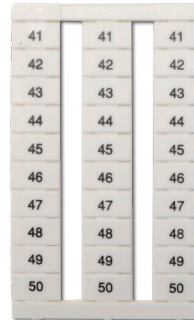

Marking Tags 5 x 10mm, 6 x 10mm, 10 x 10mm

Marking Tags Ordering Information			
Part Number*	Description	Qty	Price
<u>KN-L5X-BLNK-220</u>	Blank marking tag, 5x10mm, use with any Konnect-It terminal block series	220	\$10.50
<u>KN-L6X-BLNK-180</u>	Blank marking tag, 6x10mm, use with any Konnect-It terminal block 6mm or wider	180	\$9.75
<u>KN-L10X-BLNK-100</u>	Blank marking tag, 10x10mm, use with any Konnect-It terminal block 10mm or wider	100	\$14.50
<u>KN-L5X-BLNK</u>	Blank marking tag, 5x10mm, use with any Konnect-It terminal block series	440	\$19.50
<u>KN-L6X-BLNK</u>	Blank marking tag, 6x10mm, use with any Konnect-It terminal block 6mm or wider	360	\$18.50
<u>KN-L10X-BLNK</u>	Blank marking tag, 10x10mm, use with any Konnect-It terminal block 10mm or wider	200	\$26.50

*Does not fit any KN-T1/0xx or [KN-G1/0](#) series block

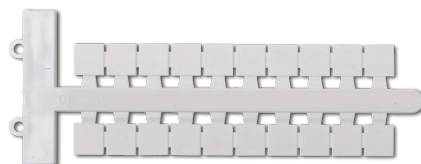

DINnectors[®] Accessories

Steel DIN Rails Features

35mm wide

- Available in 1-meter lengths
- 7.5 mm-high rails primarily used to mount terminal blocks, relays, timers and small PLCs such as the BRX, CLICK, DirectLogic and Productivity series. 15mm-high rails for mounting larger and heavier components such as contactors and larger PLCs

15mm wide

- Available in 1-meter lengths
- DN-R15S1 exclusively for mounting mini terminal blocks such as the [DN-M10-A](#)

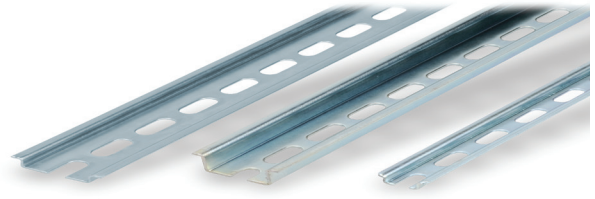

Steel DIN Rails Specifications									
	Part Number	Qty	Price	Part Number	Qty	Price	Part Number	Qty	Price
DIN Rail	DN-R35S1	10	\$39.00	DN-R35HS1	10	\$68.00	DN-R15S1	10	\$36.00
	DN-R35S1-2	2	\$11.00	DN-R35HS1-2	2	\$16.50	DN-R15S1-2	2	\$10.00
Description	DINnectors DIN rail, slotted, 35mm width, 7.5mm height, 1m length, plated steel. Package of 10.			DINnectors DIN rail, slotted, 35mm width, 15mm height, 1m length, plated steel. Package of 10.			DINnectors DIN rail, slotted, 15mm width, 5.5mm height, 1m length, plated steel. Package of 2.		
Plating	Zinc-plated and chromated								
International Standards	EN 60715, RoHs								
Suggested Mounting Screw Type	M6			M6			M4		

Aluminum DIN Rail Features

35mm wide

- Non-anodized finish
- Zinc plating and passivation (minimum thickness 6 microns)
- Lightweight, easy to cut and deburr
- Terminal blocks only
- Maximum mounting screw #10-32 or M5
- Available in 1-meter lengths

35mm wide raised

- Non-anodized finish
- Zinc plating and passivation (minimum thickness 6 microns)
- Enables users to raise terminal blocks 2¼" above the back panel
- Terminal blocks only
- Available in 1-meter lengths
- Bushing or grommet recommended for wire access hole (example Heyco UB-875 not sold by ADC)



Aluminum DIN Rails Specifications						
	Part Number	Qty	Price	Part Number	Qty	Price
DIN Rail	DN-R35SAL1	10	\$60.00	DN-R35SAL2-2	2	\$38.00
	DN-R35SAL1-2	2	\$16.00			
Description	DINnectors DIN rail, slotted, 35mm width, 10mm height, 1m length, aluminum. Package of 10.			DINnectors DIN rail, slotted, 2in raised 35mm width, 7.5mm height, 1m length, aluminum. Package of 2.		
Plating	Galvanic zinc plating, non-anodized finish					
International Standards	DIN 50960, RoHs					
Suggested Mounting Screw Type	#10-32 or M5					

DINnectors Accessories

DIN rail support brackets

- Angled support brackets raise and tilt mounting rails 30 degrees from mounting surface for easier wiring
- [DN-ASB1](#) plated steel support bracket
- [DN-ASB2-10](#) cold-rolled steel treated with galvanic zinc plating and passivation

DIN rail mounting clips

- Snap small devices not made for mounting onto 35mm DIN rails
- Zinc plated steel

DIN Rail Support Brackets and Mounting Clips			
Part Number	Description	Qty	Price
DN-ASB1	30° angled DIN rail support bracket (M6-1.0 screws not included)	50	\$107.00
DN-ASB2-10	30° angled DIN rail support bracket (M6-1.0 screws included)	10	\$18.00
DN-SSB25-10	1" (25mm) DIN rail support bracket (M6-1.0 screws included)	10	\$24.50
DN-SSB50-10	2" (50mm) DIN rail support bracket (M6-1.0 screws included)	10	\$25.50
DN-SSB70-10	2.75" (70mm) DIN rail support bracket (M6-1.0 screws included)	10	\$32.00
DN-SSB90-10	3.5" (90mm) DIN rail support bracket (M6-1.0 screws included)	10	\$34.50
DN-CLIP-FM4	DIN rail mounting clip with M4 x 0.7 mm threaded hole (Screws not included)	40	\$66.00
DN-CLIP-FM4-5		5	\$9.50
DN-CLIP-FM5	DIN rail mounting clip with M5 x 0.8 mm threaded hole (Screws not included)	40	\$66.00
DN-CLIP-FM5-5		5	\$9.50

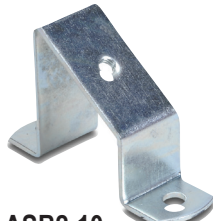
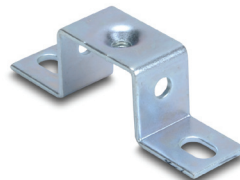
[DN-ASB1](#)[DN-ASB2-10](#)[DN-SSB25-10](#)[DN-SSB50-10](#)[DN-SSB70-10](#)[DN-SSB90-10](#)[DN-CLIP-FM4](#)
[DN-CLIP-FM4-5](#)[DN-CLIP-FM5](#)
[DN-CLIP-FM5-5](#)