

IDEM TouchSafe Two-Hand Control Panels



IDEM TouchSafe Two-Hand Control Panels are an all-in-one-box solution that is ergonomic, easy to set up, and easy to use. These panels take the guesswork out of two-hand pushbutton spacing and provide straightforward mounting options.



2H-240001



2H-240002

Applications

Two-hand control panels are designed for use in combination with a two-hand control monitoring device and require an operator to use both hands at the same time when initiating a hazardous operation. This forces operators to have their hands on the two-hand control actuator elements and out of the danger zone while the system is actuated.

Safety Design

These panels are designed with guard hoods over the actuator elements, which prevent individuals from circumventing the protection function using just one hand or other body parts. For additional safety, these two-hand control panels have been designed so that it is not possible to operate them from the back side of a panel. The two-hand control station is a complementary device designed to ensure that the operator's hands remain away from a hazard. Additional safety measures – for example, guarding – may be needed to ensure operator safety.

Features

- Pre-installed two-hand pushbuttons for ease of installation
- Five additional pre-drilled M22 holes (ships with hole covers installed)
- Ergonomic operation
- Two-part enclosure
- Die-cast aluminum enclosure
- Ability to be wall mounted
- Guard hoods over the actuator elements
- Safety yellow and black finish
- Optional empty enclosure
- Convenient terminal block inside the enclosure



IDEM Two-Hand Control Panel Selection Guide

Part Number	Price	Type of Pushbutton	Pushbutton Contacts	Ingress Protection	Weight (kg [lb])	Drawing
Control Panel Versions With Pushbuttons						
2H-240001	\$724.00	Zero Force touch switch with LED indication	2 (1 NO, 1 NC)	IP65	5.4 [11.92]	PDF
2H-240002	\$593.00	Mechanical momentary pushbuttons	2 (1 NO, 1 NC)	IP65	5.5 [12.19]	PDF

Control Panel Without Pushbuttons Selection Guide

Part Number	Price	Type of Pushbutton	Pushbutton Contacts	Ingress Protection	Weight (kg [lb])	Drawing
2H-240000	\$406.00	Aluminum die-cast, powder coated	Two 30mm holes (for two-hand control buttons) and five 22mm holes for additional buttons or lamps	IP65	5.2 [11.40]	PDF



IDEM TouchSafe Two-Hand Control Panels – Connections



The enclosure features an internal connection PCB. This board makes it very simple to change out a pushbutton or a light, reducing the overall cost of ownership. The PCB has two M12 5-pin connectors for connection to either of IDEM's pushbuttons (the [2H-240021](#) Zero Force pushbutton or the [2H-240022](#) mechanically activated pushbutton) for two-hand control. In addition, the board provides four V+ terminals, four V- terminals, and eight pairs of pass-through terminals for end-user use.

PCB Connections

IDEM TouchSafe Two Hand Control Panels PCB Terminals Wiring Connections		
Top-Row Terminals		
Terminal	Connects to	Description
V+	DC supply	Required when using Zero Force type buttons
V-	DC supply	Required when using Zero Force type buttons
NC1	Button 1	Normally closed (NC) circuit
COM1	Button 1	Common
NO1	Button 1	Normally open (NO) circuit
NC2	Button 2	Normally closed (NC) circuit
COM2	Button 2	Common
NO2	Button 2	Normally open (NO) circuit

Pass-Through Terminals		
Terminal	Connects to	Description
A1	A2	Common connection for end user use
B1	B2	Common connection for end user use
C1	C2	Common connection for end user use
D1	D2	Common connection for end user use
E1	E2	Common connection for end user use
F1	F2	Common connection for end user use
G1	G2	Common connection for end user use
H1	H2	Common connection for end user use

Bottom-Row Common Terminals		
Terminal	Connects to	Description
All V+	Internally connected	Common connection for end user use
All V-	Internally connected	Common connection for end user use

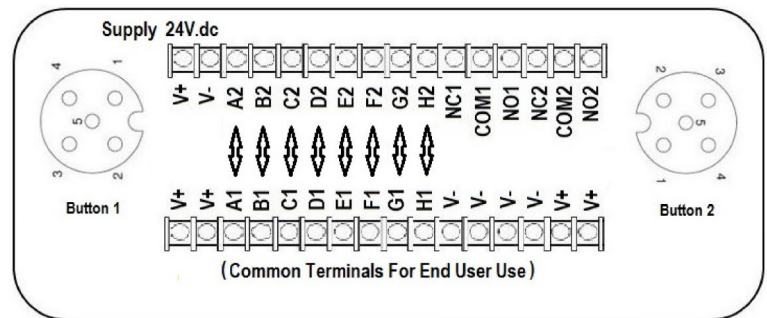

IDEM Zero Force Touch Switch For Two-Hand Control



IDEM Zero Force Touch Switch	
Part Number	<u>2H-240021</u>
Price	\$187.00
Description	IDEM touch switch, IP65, 30mm, zero force, LED illuminated, (1) N.O./ (1) N.C. contact(s), black, mushroom, 68mm, round.
Mounting Diameter	30mm [1.18 in]
Actuating Stroke	Zero stroke (touch sensitive)
Pushbutton Material	Polyester
Front Panel Thickness	2 to 9 mm [0.08 to 0.35 in]
Weight	139g [0.31 lb]
Mounting Screws Tightening Torque	1.0 N•m [0.74 lb•ft]
Ambient Temperature	-20°C to +40°C [-4°F to +104°F]
Ingress Protection Rating	IP65
Standards	ISO 13851; UL File E258676
Drawing	PDF

The IDEM Zero Force Touch Switch is activated when touched. The switch does not require any force to activate. It was designed to eliminate hand or wrist stresses associated with frequent repetitive machine operations. It features solid state construction as well as high-visibility LED status indication (red when the button is not being touched, as shown at left, or green when the button is being touched).

This touch switch is supplied with a 250mm [9.84 in] flying lead with a 5-pin M12 male plug. The plug makes it easy to connect to the PCB connection board which is part of IDEM's two-hand control stations.

Note that if gloves must be worn by the operator, mechanical pushbuttons (such as [2H-240022](#)) should be used instead.

Cable Connections

5-Pin M12 Connections	
1	+24VDC
2	NC contact
3	0 VDC
4	NO contact
5	Common

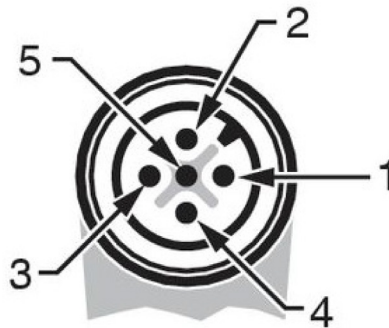

Safety Products



Warning: Safety products sold by AutomationDirect are Safety components only. The purchaser/installer is solely responsible for the application of these components and ensuring all necessary steps have been taken to assure each application and use meets all performance and applicable safety requirements and/or local, national and/or international safety codes as required by the application. AutomationDirect cannot certify that our products, used solely or in conjunction with other AutomationDirect or other vendors' products, will assure safety for any application. Any person using or applying any products sold by AutomationDirect is responsible for learning the safety requirements for their individual application and applying them, and therefore assumes all risks, and accepts full and complete responsibility, for the selection and suitability of the product for their respective application.

AutomationDirect does not provide design or consulting services, and cannot advise whether any specific application or use of our products would ensure compliance with the safety requirements for any application.