

Safety Limit Switches Selection Guide



Series	HLM Series	HLM-SS Series	LSPS Series
Prices start at	\$78.00	\$166.00	\$26.50
Description	Die-cast metal body safety limit switch	Stainless steel body safety limit switch	Plastic body safety limit switch
Material of Construction	Die-cast zinc aluminum casing	Stainless steel 316 casing	Plastic casing
Degree of Protection (IEC529)	IEC IP67	IEC IP67/IP69	IEC IP67
Maximum Switching Frequency	6,000 operations/day	6,000 operations/day	6,000 operations/day
Mechanical Service Life	2,500,000 cycles	2,500,000 cycles	2,500,000 cycles
Contact Configuration	Each model available with: 2 N.C. / 2 N.O. slow action break before make contacts, or 1 N.O. / 1 N.C. snap action contacts	Each model available with: 2 N.C. / 2 N.O. slow action break before make contacts, or 1 N.O. / 1 N.C. snap action contacts	Each model available with: 2 N.C. / 2 N.O. slow action break before make contacts, or 1 N.O. / 1 N.C. snap action contacts
Conduit Opening	One cable hole	One cable hole	One cable hole
Connection	1/2 inch female NPT conduit	1/2 inch female NPT conduit	1/2 inch female NPT conduit
Agency Approvals	CE, UL (file E258676)	CE, UL (file E258676)	CE, UL (file E258676)



Series	LSMM Series	LSPM Series	AP2 Series
Prices start at	\$48.00	\$36.00	\$15.50
Description	Panel mount die-cast metal body safety limit switch	Panel mount plastic body safety limit switch	30 mm limit switches with pull button reset
Material of Construction	Die-cast zinc aluminum casing	Plastic casing	Plastic casing, double insulated
Degree of Protection (IEC529)	IEC IP67	IEC IP67	IEC IP65
Maximum Switching Frequency	6,000 operations/day	6,000 operations/day	Contact blocks: 1 cycle per second (all)
Mechanical Service Life	2,500,000 cycles	2,500,000 cycles	1,000,000 operations interlock and limit switches
Contact Configuration	Each model available with: 2 N.C. / 1 N.O. slow action break before make contacts, or 1 N.O. / 1 N.C. snap action contacts	Each model available with: 2 N.C. / 1 N.O. slow action break before make contacts, or 1 N.O. / 1 N.C. snap action contacts	X11 - Slow action break before make, positive opening, 1 N.O. + 1 N.C. W02 - Simultaneous, slow action, positive opening, 2 N.C.
Conduit Opening	One cable hole	One cable hole	One cable hole, 1/2" NPT adapter
Connection	Pigtail; 2m / 6.5 ft cable length	Pigtail; 2m / 6.5 ft cable length	2x2.5mm2 (AWG14) to 2x0.5mm2 (AWG 18)
Agency Approvals	CE, UL (file E258676)	CE, UL (file E258676)	CE, UL file E189258, CSA 176294, RoHS

IDEM Type HLM-SS (Stainless Steel 316 Body) Safety Limit Switches

IDEM limit switches are designed to be mounted for position sensing applications, such as guard doors, conveyors, machine beds, elevators, etc. These Stainless Steel switches have a IP69K rating which makes them suitable for high-temperature washdown with detergent.

They are available with a range of actuator heads and either slow or snap action contacts.

Features

- Heavy duty Stainless Steel 316 bodies
- Direct opening NC safety contact(s) to EN60947-5-1
- High mechanical life: Over 5 million cycles
- Industry standard mounting to EN50041



HLM-SS-175002



HLM-SS-175052



HLM-SS-175102



HLM-SS-175252



HLM-SS-175302

IDEM Type HLM-SS (Stainless Steel 316 Body) Safety Limit Switches						
Part Number	Price	Type	Contacts	Action	Bar Chart	Connection
HLM-SS-175002	\$173.00	Side rotary lever with stainless steel roller	2 N.C. safety contacts / 2 N.O. monitoring contacts	Slow action break before make	A	1/2 inch female NPT conduit
HLM-SS-175011	\$173.00		1 N.C. safety contact / 1 N.O. monitoring contact	Snap action	B	
HLM-SS-175052	\$166.00	Plunger with stainless steel roller	2 N.C. safety contacts / 2 N.O. monitoring contacts	Slow action break before make	C	
HLM-SS-175061	\$166.00		1 N.C. safety contact / 1 N.O. monitoring contact	Snap action	D	
HLM-SS-175102	\$166.00	Stainless steel plunger	2 N.C. safety contacts / 2 N.O. monitoring contacts	Slow action break before make	C	
HLM-SS-175111	\$166.00		1 N.C. safety contact / 1 N.O. monitoring contact	Snap action	D	
HLM-SS-175252	\$173.00	Side rotary adjustable stainless steel rod	2 N.C. safety contacts / 2 N.O. monitoring contacts	Slow action break before make	A	
HLM-SS-175261	\$173.00		1 N.C. safety contact / 1 N.O. monitoring contact	Snap action	B	
HLM-SS-175302	\$176.00	Side rotary adjustable lever with stainless steel roller	2 N.C. safety contacts / 2 N.O. monitoring contacts	Slow action break before make	A	
HLM-SS-175311	\$176.00		1 N.C. safety contact / 1 N.O. monitoring contact	Snap action	B	

Bar Charts

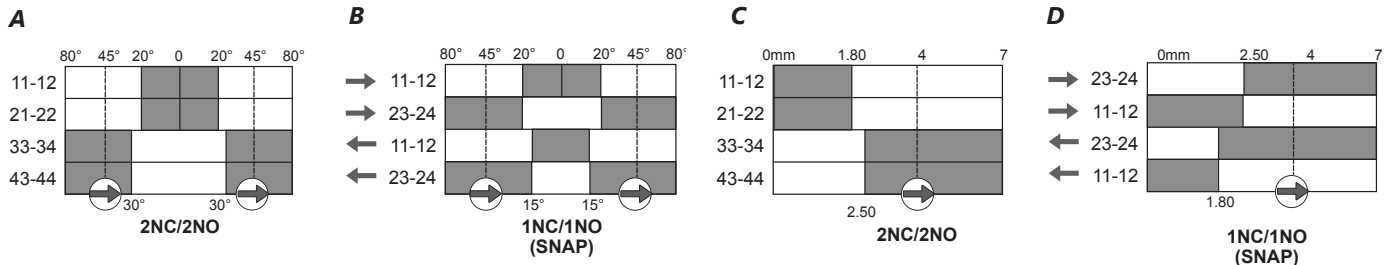

Contacts Configuration Charts

Slow Action 2NC 2NO

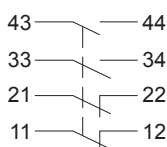

Snap Action 1NC 1NO

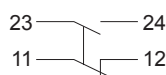

IDEM Type HLM-SS (Stainless Steel 316 Body) Safety Limit Switches

Dimensions

mm [in]

HLM-SS-175002
HLM-SS-175011

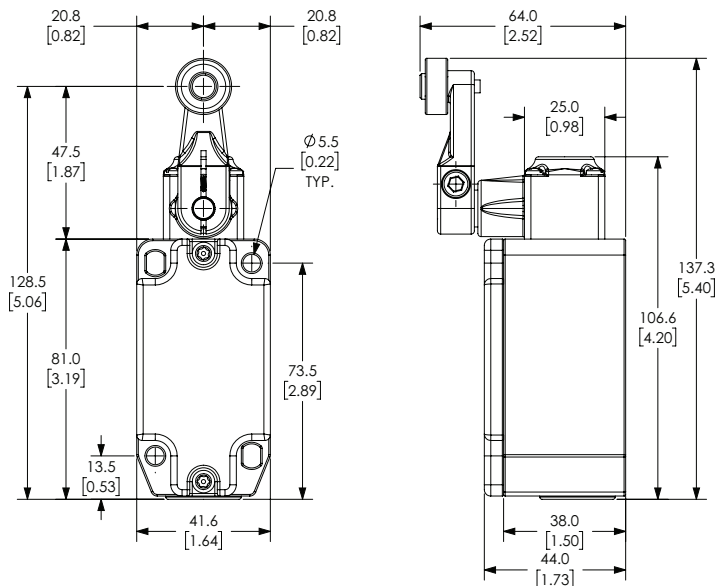

HLM-SS-175052
HLM-SS-175061

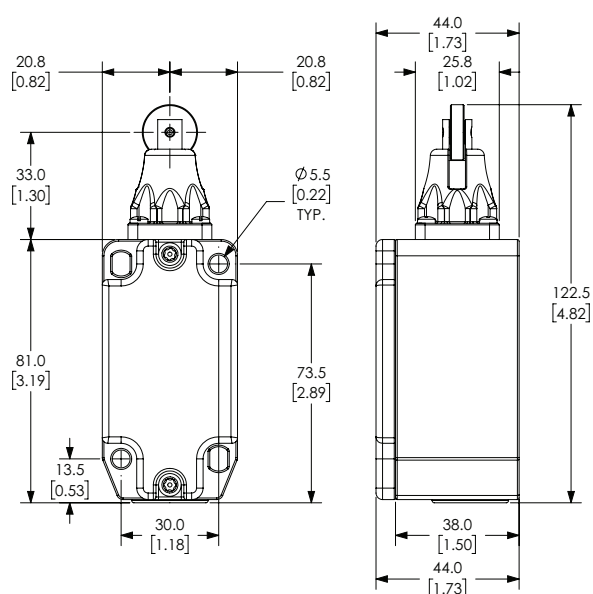

HLM-SS-175252
HLM-SS-175261

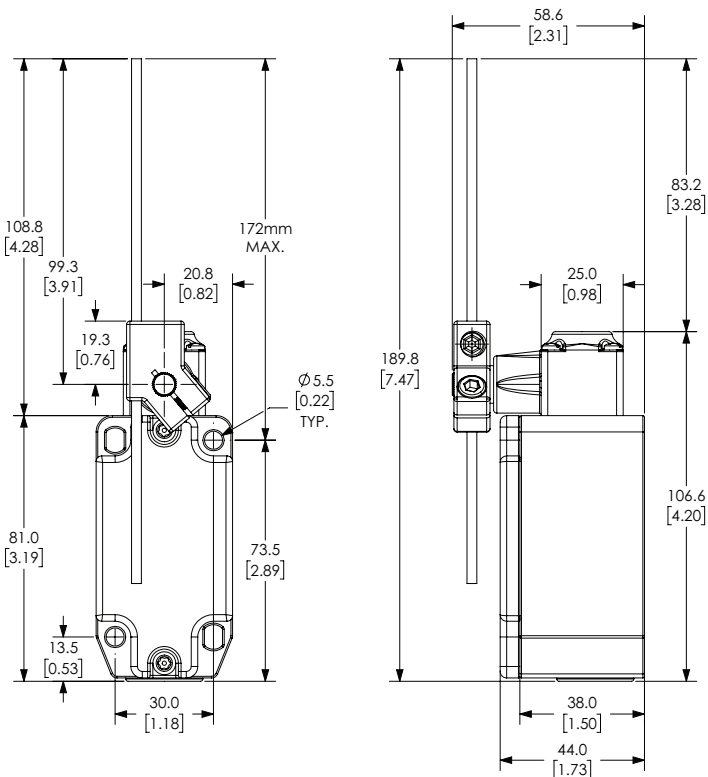

HLM-SS-175102
HLM-SS-175111

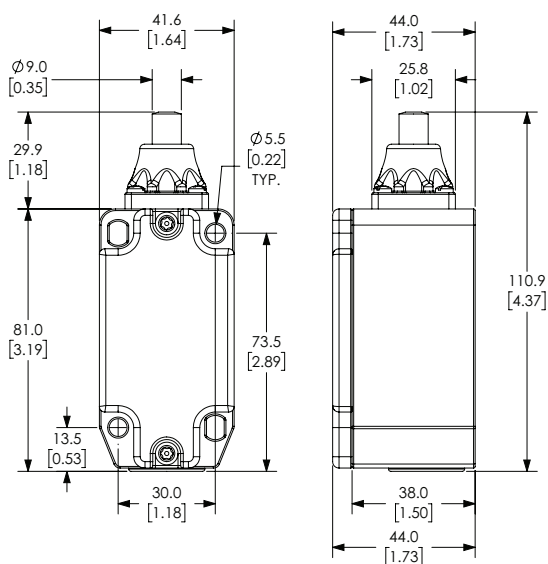

IDEM Type HLM-SS (Stainless Steel 316 Body) Safety Limit Switches

HLM-SS-175302
HLM-SS-175311

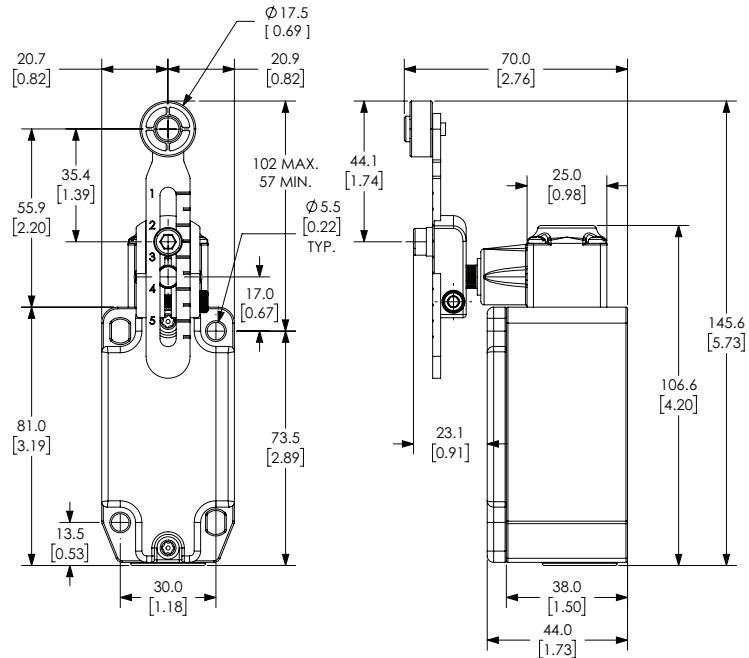

IDEM Type HLM-SS (Stainless Steel 316 Body) Safety Limit Switches Specifications	
Safety Characteristic Data	
Performance level	Up to PLe depending on the system architecture
Category	Up to Cat 4 depending on the system architecture
Safety Integrity Level	Up to SIL3 depending on the system architecture
B10d	2.5 x 10 ⁶ operations
Safety Data - Annual Usage	8 cycles per hour / 24 hours per day / 365 days
MTTFd	356 years
PFHd (1/h)	3.44 x 10 ⁻⁸
Proof Test Interval T1	35 years
Electrical and General Specifications	
Utilization Category	AC15 A300 240V, 3A
Minimum Switched Current	5mA, 5VDC
Thermal Current	10A
Rated Insulation Voltage	300VAC
Max. Switching Speed	250 mm/sec
Max. Switching Frequency	6,000 operations/day
Case Material	Stainless steel 316
Operating Temperature	-25° to +80°C [-13° to +176°F]; (cleaning to +105°C [+221°F])
Enclosure Protection	IP67/IP69K
Mechanical Life Expectancy	2,500,000 cycles
Vibration	IEC 68-2-6
Conductor Size	1.5 mm ²
Head Screws/Torque	1Nm
Lid Screws/Torque	1Nm
Recommended Mounting Bolt Torque	2Nm
Recommended Mounting Screws	M5
Agency Approvals	CE, UL (file E258676)

Note: When the product is used differently from the assumptions shown (different load, operating frequency, etc.) the values must be adjusted accordingly.

IDEM Safety Limit Switches - Operation, Installation and Maintenance



Note: These guidelines apply to all IDEM Safety Limit Switches

Operation:

Operation of the switches is achieved when a moving object causes deflection of the switch plungers or levers.

For safety applications it is important that the moving object does not pass completely over the switch actuators so as to cause the actuator to return to its original position.

Installation Guide:

Correct mounting of limit switches is critical to obtain optimum performance and ensure safety reliability.

Installation of all switches must be in accordance with a risk assessment for the individual application.

Installation must only be carried out by competent personnel and in accordance with these instructions.

1. Never use the switch as a mechanical stop. Ensure that the actuator is protected from mechanical shock.
2. For switches with linear actuators the actuating direction and force from the moving object should be applied in line with the axis of the plunger.
3. For switches with rotary actuators or rollers the operating cam from the moving object should be designed such that the switch is never operated beyond its over travel position. Always use a 30 degree tapered actuating cam.

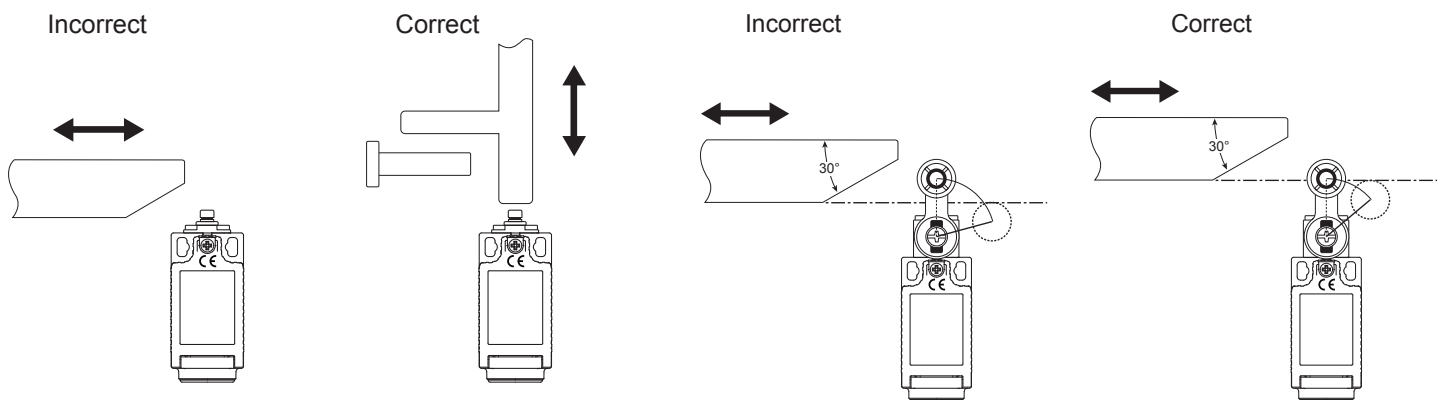

4. Always ensure that when running electrical conductors that they are routed correctly and no damage can occur to the cable insulation.
5. Always use correct mounting bolts (M4 or M5 depending on the switch model) and ensure 2Nm tightening torque for secure fitting.
6. Ensure 1Nm tightening torque for conduit plugs and cable glands to achieve IP rating.
7. The safety functions and mechanics must be tested regularly. For applications where infrequent guard access is foreseeable, the system must have a manual function test to detect a possible accumulation of faults. Do this at least once per month for PLe Cat3/4 or once per year for PLd Cat3 (ISO13849-1). Where possible, it is recommended that the control system of the machine demands and monitors these tests, and stops or prevents the machine from starting if the test is not done. (See ISO14119).

Maintenance:

Every Month: Check switch actuator and body for signs of mechanical damage and wear. Replace any switch showing damage.

Every 6 Months: Isolate power and remove cover. Check screw terminal tightness and check for signs of moisture ingress. Never attempt to repair any switch.

Safety Products



Warning: Safety products sold by AutomationDirect are Safety components only. The purchaser/installer is solely responsible for the application of these components and ensuring all necessary steps have been taken to assure each application and use meets all performance and applicable safety requirements and/or local, national and/or international safety codes as required by the application. AutomationDirect cannot certify that our products, used solely or in conjunction with other AutomationDirect or other vendors' products, will assure safety for any application. Any person using or applying any products sold by AutomationDirect is responsible for learning the safety requirements for their individual application and applying them, and therefore assumes all risks, and accepts full and complete responsibility, for the selection and suitability of the product for their respective application.

AutomationDirect does not provide design or consulting services, and cannot advise whether any specific application or use of our products would ensure compliance with the safety requirements for any application.