

# High-speed Counter I/O Module



## Overview

The High-Speed Counter I/O (H4-CTRIO) module is designed to accept high-speed pulse-type input signals for counting or timing applications and designed to provide high-speed pulse-type output signals for stepper/servo motor control, monitoring, alarm or other discrete control functions. The H4-CTRIO module offers great flexibility for applications that call for precise counting or timing, based on an input event or for high-speed control output applications. The H4-CTRIO module has its own microprocessor and operates asynchronously with respect to the PLC/Controller. This means that on-board outputs respond in real time to incoming signals so there is no delay waiting for the PLC/Controller to scan I/O.

The H4-CTRIO module is designed to work with incremental encoders or other field devices that send pulse outputs.

## CTRIO features

The CTRIO modules offer the following I/O features:

- 8 DC sink/source inputs, 9-30 VDC
- 4 isolated sink/source DC outputs, 5-30 VDC, 1A per point

Inputs supported:

- 2 quadrature encoders counters up to 100kHz, or 4 single channel counters up to 100 kHz using module terminals Ch1A, Ch1B, Ch2A and Ch2B
- High-speed edge timers, dual edge timers, pulse catch, count reset, count inhibit count capture or home search limits using module terminals Ch1C, Ch1D, Ch2C or Ch2D

Outputs supported:

- 4 independently configurable high-speed discrete outputs or 2 channels pulse output control (20 Hz-25 kHz per channel)
- Pulse and direction or cw/ccw pulses supported for pulse output control
- Raw control of discrete outputs directly from the user control program

## Software Configuration

All scaling and configuration is done via CTRIO Workbench, a Windows software utility program. This eliminates the need for ladder programming to set up the module. CTRIO Workbench runs under Windows 98/2000/XP and NT 4.0 SP5 or later.

### CTRIO Workbench main configuration screen

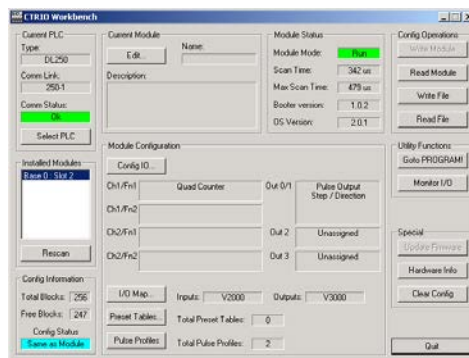

Use Configure I/O dialog to assign the CTRIO input and output functions

## Typical applications

- High-speed cut-to-length operations using encoder input
- Pick-and-place or indexing functions controlling a stepper/servo drive
- Dynamic registration for web material control
- Accurate frequency counting for speed control with onboard scaling
- PLS (Programmable Limit Switch) functions for high-speed packaging, gluing, or labeling
- Less than 10µs pulse-catch capability for high-speed product detection
- Functions for level or flow

## Supported systems

Multiple H4-CTRIO modules can reside in the same base provided that the backplane power budget is adequate.

### DirectLOGIC DL405 PLC

You can use the H4-CTRIO module with the [D4-454](#) CPU. The module plugs into any I/O slot of any DirectLogic 405 base. The CTRIO cannot be used in local expansion bases or in serial remote I/O bases.

### PC-based Ethernet I/O control systems

The [H4-CTRIO](#) module can be used in PC-based control systems using the [H4-EBC](#) interface module. H4-EBCs support the use of the H4-CTRIO in DL405 local expansion bases.

### ERM to EBC systems

The H4-CTRIO module is supported in the H4-EBC Servers in [H2-ERM100](#) or [H4-ERM100](#) systems.

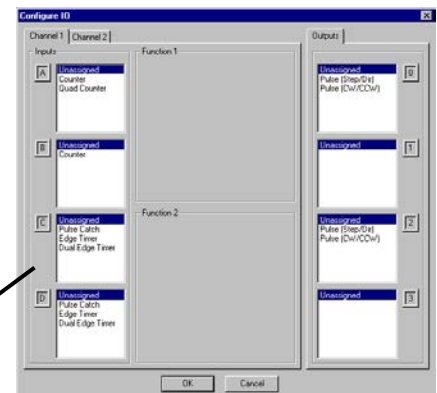

# High-speed I/O Counter Module

## I/O Specifications

| General Specifications            |   |
|-----------------------------------|---|
| <b>Module Type</b>                | Intelligent   |
| <b>Modules Per Base</b>           | Limited only by power consumption   |
| <b>I/O Points Used</b>            | None, I/O map directly in PLC V-memory or PC control access   |
| <b>Field Wiring Connector</b>     | Standard removable terminal block   |
| <b>Internal Power Consumption</b> | 400mA Max at +5V from Base Power Supply, Maximum of 6 Watts<br>(All I/O in ON State at Max Voltage/Current) |
| <b>Operating Environment</b>      | 32°F to 140°F (0°C to 60°C), Humidity (non-condensing) 5% to 95%  |
| <b>Isolation</b>                  | 2500V I/O to Logic, 1000V among Input Channels and All Outputs  |

| H4-CTRIO Input Specifications   |  |
|---------------------------------|--|
| <b>Inputs</b>                   | 8 pts sink/source                            |
| <b>Minimum Pulse Width</b>      | 5µs  |
| <b>Input Voltage Range</b>      | 9-30 VDC                                     |
| <b>Maximum Voltage</b>          | 30VDC  |
| <b>Input Voltage Protection</b> | Zener Clamped at 33VDC                       |
| <b>Rated Input Current</b>      | 8mA typical 12mA maximum                     |
| <b>Minimum ON Voltage</b>       | 9.0 VDC                                      |
| <b>Maximum OFF Voltage</b>      | 2.0 VDC                                      |
| <b>Minimum ON Current</b>       | 5.0 mA (9VDC required to guarantee ON state) |
| <b>Maximum OFF Current</b>      | 2.0 mA                                       |
| <b>OFF to ON Response</b>       | Less than 3µs                                |
| <b>ON to OFF Response</b>       | Less than 3µs                                |

| H4-CTRIO Output Specifications |  |
|--------------------------------|--|
| <b>Outputs</b>                 | 4 pts, independently isolated, current sourcing or sinking<br>FET Outputs: open drain and source with floating gate drive  |
| <b>Voltage Range</b>           | 5VDC - 36VDC   |
| <b>Maximum Voltage</b>         | 36VDC  |
| <b>Output clamp Voltage</b>    | 60VDC  |
| <b>Maximum load Current</b>    | 1.0A   |
| <b>Maximum load Voltage</b>    | 36VDC  |
| <b>Maximum Leakage Current</b> | 100µA  |
| <b>Inrush Current</b>          | 5A for 20ms  |
| <b>OFF to ON Response</b>      | less than 3µsec  |
| <b>ON to OFF Response</b>      | less than 3µsec  |
| <b>ON State V Drop</b>         | ≤ 0.3V   |
| <b>External Power Supply</b>   | For loop power only, not required for internal module function*  |
| <b>Overcurrent Protection</b>  | 15A max  |
| <b>Thermal Shutdown</b>        | Tjunction = 150°C  |
| <b>Overtemperature Reset</b>   | Tjunction = 130°C  |
| <b>Duty Cycle Range</b>        | 1% to 99% in 1% increments (default = 50%)   |
| <b>Configurable Presets</b>    | a) each output can be assigned one preset, or<br>b) each output can be assigned one table of presets, one table can contain max. 128 presets, max. predefined tables = 255 |

\* User supplied power source required for stepper drive configuration.

| H4-CTRIO Input Resources        |   |
|---------------------------------|---|
| <b>Counter/Timer</b>            | 4, (2 per 4 input channel group) up to 100kHz   |
| <b>Resource Options</b>         | 1X, 2X, or 4X Quadrature, Up or Down Counter, Edge Timer, Dual Edge Timer, Input Pulse Catch, Reset, Inhibit, Capture |
| <b>Timer Range / Resolution</b> | 4.2 billion (32 bits); 1µs  |
| <b>Counter Range</b>            | ±2.1 billion (32 bits or 31 bits + sign bit)  |

| H4-CTRIO Output Resources              |  |
|--|--|
| <b>Pulse Output / Discrete Outputs</b> | Pulse outputs: 2 channels (2 outputs each channel) (20Hz–25KHz);<br>Discrete outputs: 4 pts.   |
| <b>Resource Options</b>                | Pulse outputs: pulse/direction or cw/ccw; Profiles: Trapezoid, S-Curve, Symmetrical S-Curve, Dynamic Position, Dynamic Velocity, Home Search, Velocity Mode, Run to Limit Mode and Run to Position Mode<br>Discrete outputs: 4 configurable for set, reset, pulse on, pulse off, toggle, reset count functions (assigned to respond to Timer/Counter input functions).<br>Raw mode: Direct access to discrete output from user application program |
| <b>Target Position Range</b>           | ±2.1 billion (32 bits or 31 bits + sign bit)   |

# High-speed I/O Counter Module

## Status indicators

| H4-CTRIO LED Descriptions |                          |
|---------------------------|--------------------------|
| <b>OK</b>                 | Module OK                |
| <b>ER</b>                 | User Program Error       |
| <b>1A - 1D</b>            | Ch1A - Ch1D Input Status |
| <b>2A - 2D</b>            | Ch2A - Ch2D Input Status |
| <b>(Ch1) F1 - F2</b>      | Ch1 Resource State       |
| <b>(Ch2) F1 - F2</b>      | Ch1 Resource State       |
| <b>Y0 - Y3</b>            | Output Status            |

| H4-CTRIO LED Diagnostic Definitions |          |   |
|-------------------------------------|----------|---|
| LED OK                              | LED ER   | Description                                   |
| <b>ON</b>                           | OFF      | All is well - RUN Mode                        |
| <b>Blinking</b>                     | Blinking | Boot Mode - Used for Field OS Upgrades        |
| <b>Blinking</b>                     | OFF      | Program Mode                                  |
| <b>OFF</b>                          | Blinking | Module Self-diagnostic Failure                |
| <b>OFF</b>                          | ON       | Module Error Due to Watchdog Timeout          |
| <b>OFF</b>                          | OFF      | No Power to Module                            |
| <b>TB</b>                           |          | User Terminal Block is not Properly Installed |

| H4-CTRIO LED Diagnostic Definitions |  |
|-------------------------------------|--|
| <b>1A - 1D</b>                      | Follow actual input state / Ch1                            |
| <b>2A - 2D</b>                      | Follow actual input state / Ch2                            |
| <b>(Ch1) F1</b>                     | Blinks when Channel 1 Function 1 is counting or timing     |
| <b>(Ch1) F2</b>                     | Blinks when Channel 1 Function 2 is counting or timing     |
| <b>(Ch2) F1</b>                     | Blinks when Channel 2 Function 1 is counting or timing     |
| <b>(Ch2) F2</b>                     | Blinks when Channel 2 Function 2 is counting or timing     |
| <b>Y0 - Y3</b>                      | Follow actual output state; ON = output is passing current |

## Installation and wiring

The H4-CTRIO module has two independent input channels, each consisting of 4 optically isolated input points (pts. 1A-1D on common 1M and pts. 2A-2D on common 2M). The inputs can be wired to either sink or source current.

The module has 4 optically isolated output points (pts. Y0-Y3 with isolated commons C0-C3, respectively). The outputs must be wired so positive current flows into the Cn terminal and then out of the Yn terminal (see the diagram on the following page).

The module is configured, using CTRIO Workbench, to accommodate the user's application. The function of each input (counting, timing, reset, etc.) and output (pulse output, discrete output, etc.) is defined in the configuration of the module.

See the notes below for further details about power source considerations, circuit polarities, and field devices.

## Notes:

- Inputs (1A, 1B, 1C, 1D and 2A, 2B, 2C, 2D) require user-provided 9-30 VDC power sources. Terminals 1M and 2M are the commons for Channel 1 and Channel 2 inputs. Maximum current consumption is 12mA per input point.
- Polarity of the input power sources (shown right) can be reversed. Consideration must be given, however, to the polarity of the field device. Many field devices are designed for only one polarity and can be damaged if power wiring is reversed.
- Outputs have one polarity only (as shown) and are powered by user provided 5-36 VDC power sources. The maximum allowable current per output circuit is 1A.

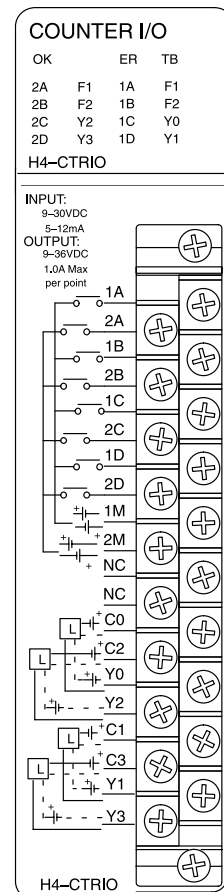
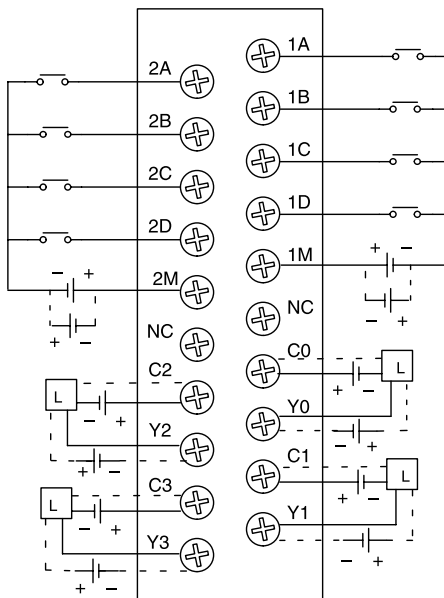

# High-speed I/O Counter Module

## Solid state input wiring device

DC types of field devices are configured to either sink or source current. This affects the wiring of the device to the CTRIO module. Refer to the sinking/sourcing appendix in this desk reference for a complete explanation of sinking and sourcing concepts.

### NPN Field Device (sink)

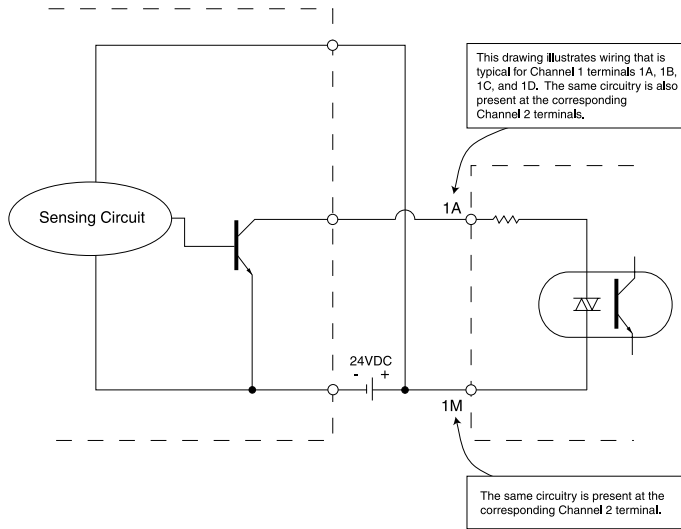

### PNP Field Device (source)

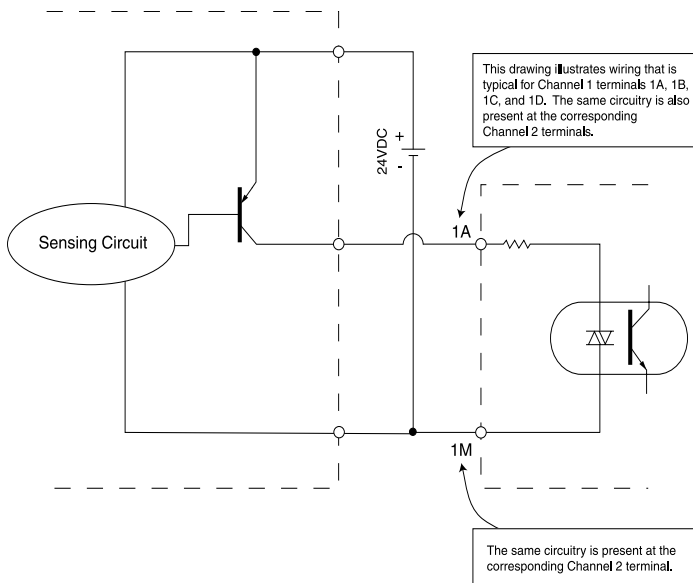

## Pulse output schematic

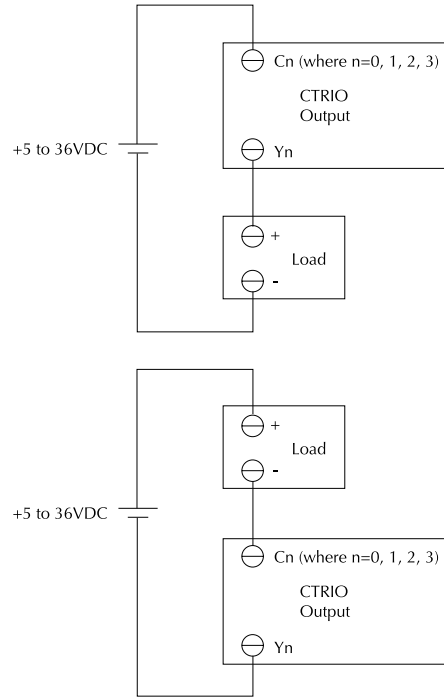

## Stepper/Servo drive wiring example

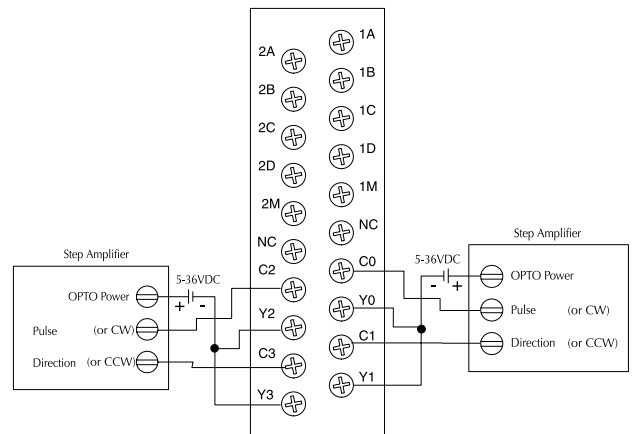

# High-speed I/O Counter Module

## Fill-in-the-blank configuration software

The CTRIO Workbench is the software utility used to configure the CTRIO module and to scale signals to desired engineering units. Workbench also allows you to perform various other functions, such as switching between the CTRIO's Program mode and Run mode, monitoring I/O status and functions, and diagnostic control of module functions. The latest version of the CTRIO Workbench utility can be downloaded for free at the Host Engineering's Web site: [www.hosteng.com](http://www.hosteng.com).

### CTRIO Workbench configure I/O setup

The Configure I/O dialog is the location where input and output functions are assigned to the module. The choice of input and output functions determines which options are available. The input function boxes prompt you with selections for supported functions. The Workbench software automatically disallows any unsupported configurations.

Configure I/O Screen

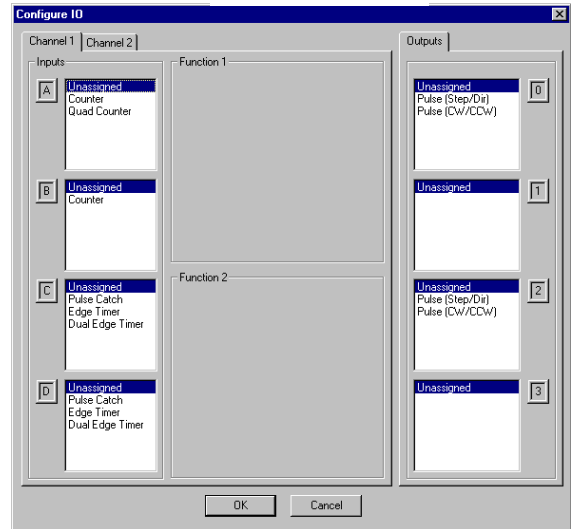

CTRIO Workbench main configuration screen

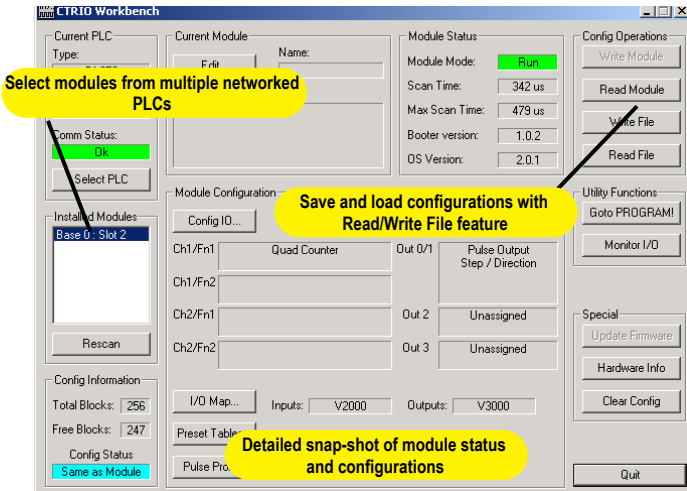

### CTRIO Workbench diagnostics and monitoring

The Monitor I/O dialog is accessible from the main Workbench dialog when the module is in Run Mode. This allows for a convenient way to test and debug your configuration prior to installation. The Monitor I/O dialog is divided into three functional areas: Input Functions, Output Functions and System Functions. The data displayed under the Input Functions tab includes all input Dword parameters, status bits and the current status of each configured input and output function. The fields displayed under the Output Functions tab includes all output Dword parameters and configuration information that can be altered during runtime and the bits that indicate successful transfers or errors. The System Functions can be used to read from or write to the CTRIO's internal registers.

### CTRIO Workbench on-board scaling

Scaling raw signals to engineering units is accomplished using the Scaling Wizard. The Scaling Wizard options are different for the Counter functions as compared with the Timer functions. "Position" and "Rate" scaling are available when you select a Counter function. "Interval" scaling is available when you select a Timing function.

Scaling Wizard screen

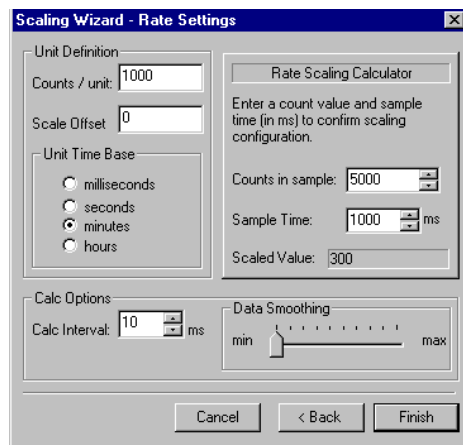

Monitor I/O screen

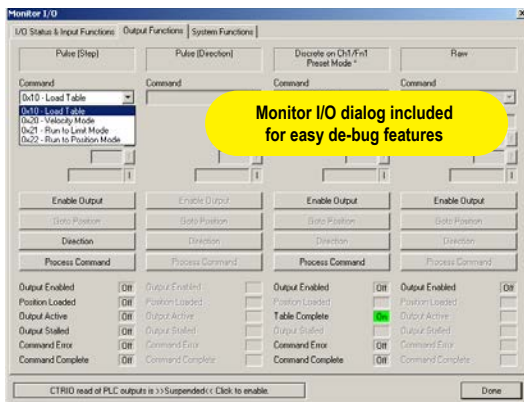



# High-speed I/O Counter Module

## High-speed input operations

The CTRIO module is capable of a wide variety of high speed input and output operations all within one module. With its flexible 2-channel input and separate 2-channel output design, the CTRIO can satisfy both high-speed counting, timing, pulse catch operations, along with high speed discrete output or several profile choices of pulse output operations. Not all combinations of input functions and output functions are possible within the resources of the module, but the following examples are some of the most common applications for the CTRIO. Check out these examples and see how they relate to your high-speed application needs.

### High-speed timing

The CTRIO can be configured for timing functions based on both count or rate. Using a common configuration of a proximity switch sensing the teeth on a gear, the module is able to calculate the velocity of the gear based on the rate it receives its counts. This value can be scaled within the module to the engineering units required for the application.

### High-speed timing application

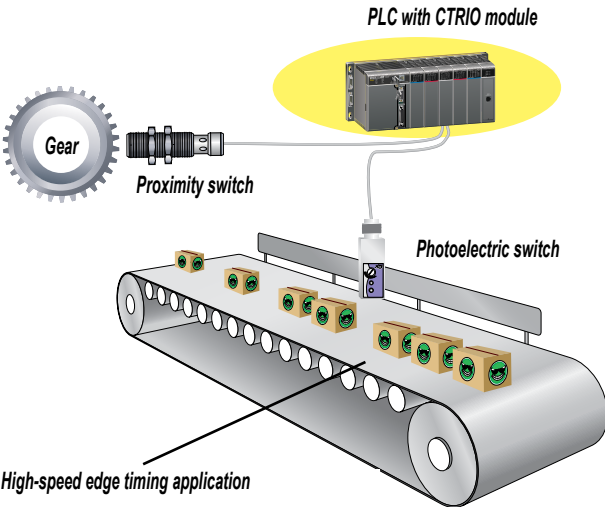

### High-speed edge timing application

#### Using Configure I/O screen to configure CTRIO for high-speed timing

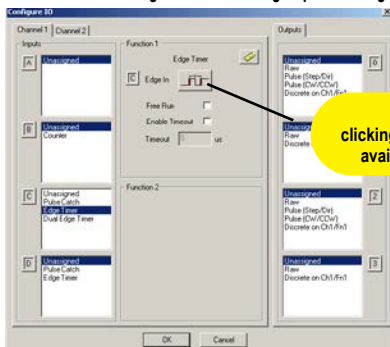

### High-speed counting

The CTRIO can be configured for counting functions for the use of an encoder input, (up to two quadrature encoders per module) with available connections for external reset and inhibit signals. In a simple cut to length application as shown, the encoder provides an input position reference for the material to the module. The module's high-speed outputs are wired to the cutting device and to the clutch and/or braking device. When the count from the encoder is equal to a pre-programmed setpoint within the module, the high speed outputs are activated to stop and cut the material to a repeatable fixed length. Additionally, the clutch/brake signal can be used for an inhibit signal to not accumulate counts while the material is being cut.

### High-speed cut-to-length application

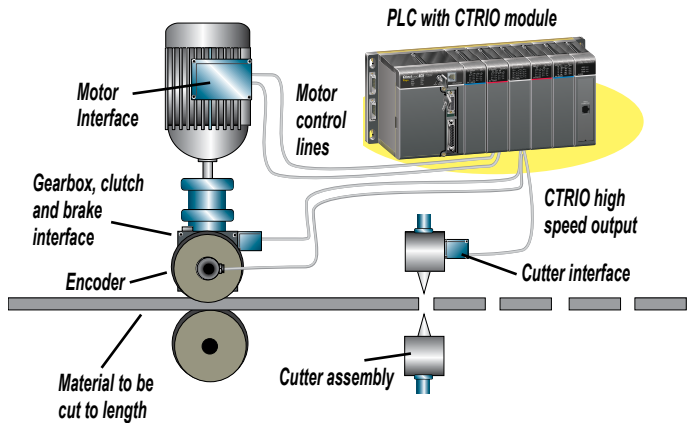

#### Using Configure I/O screen to configure CTRIO for high-speed counting

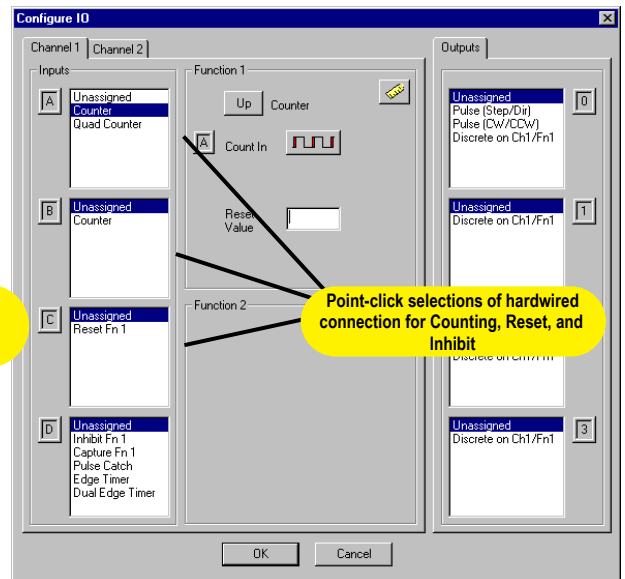

# High-speed I/O Counter Module

## Pulse output operations

Using Edit Pulse Profile screen to select Trapezoid pulse output profile

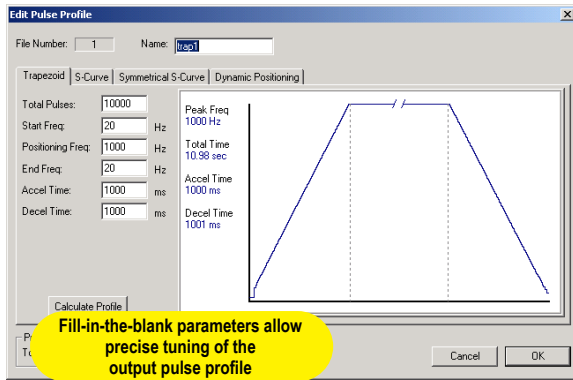

### Pulse output for stepper/servo control

The CTRIO module is capable of multiple configurations for pulse output control, most often when connected to a stepper or servo drive system. The module can deliver a pulse output signal up to a maximum of 25 kHz on two channels with support for pulse-and-direction or CW/CCW pulses. The available profile choices include Trapezoid, S-Curve, Symmetrical S-Curve, Dynamic Positioning, Dynamic Velocity and Home Search. All profiles can be easily configured using the CTRIO Workbench software with fill-in-the-blank parameter fields and a graphic representation of the selected profile. Three additional profiles are available which are completely controlled by the user program. They are Velocity Mode, Run to Limit Mode and Run to Position Mode.

### Example application

In a simple rotary indexing application, as shown above, a fixed Trapezoid profile is chosen. The CTRIO for this application is wired to a stepper drive for pulse-and-direction. The requirement for this application is to provide a smooth movement of the rotary table to allow product to be filled into individual containers equal distance apart. The predetermined number of pulses required for each movement is entered into the CTRIO Workbench as Total Pulses along with the Starting Frequency, Ending Frequency, and Positioning Frequency (speed after acceleration). The Acceleration and Deceleration parameters are entered in units of time, so no ramp-distance calculations are required. After all parameters are entered, a graphical representation of the configured profile is shown automatically. Once the configuration has been downloaded to the module, all that is needed from the PLC CPU is to load the profile and enable the output signal to begin a movement.

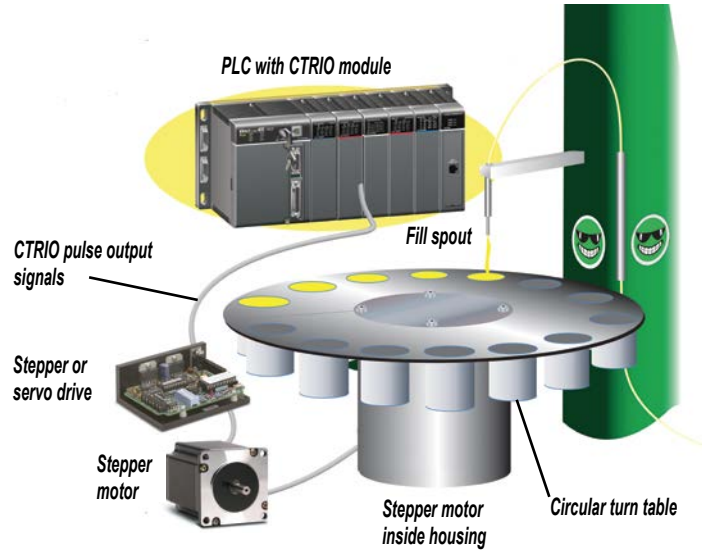

### Rotary indexing liquid fill application

### Other common pulse output applications:

- S-Curve accel/dec profile for signaling a stepper or servo drive that needs a curved acceleration and deceleration profile, i.e. for diminishing any initial "jerk" upon movement of static products, boxes on conveyors, liquids in containers on an indexer, printing registrations, etc.
- Dynamic Positioning for any run-to-a-specific-position requirement, either by a pre-programmed count or an external high speed discrete input wired to the module. This is popular in winding or web control with any dynamic registration mark or variable speed requirement.
- Home Search routines to seek a home position based on CTRIO discrete input limit(s).

### Example of S-Curve acceleration and deceleration pulse output profile

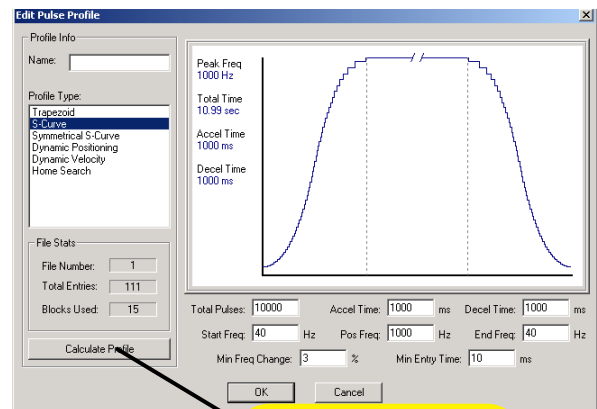

# High-speed I/O Counter Module

## Combining high-speed input and pulse output operations

Using CTRIO Workbench to configure the module for simultaneous high-speed input and high-speed pulse output operation

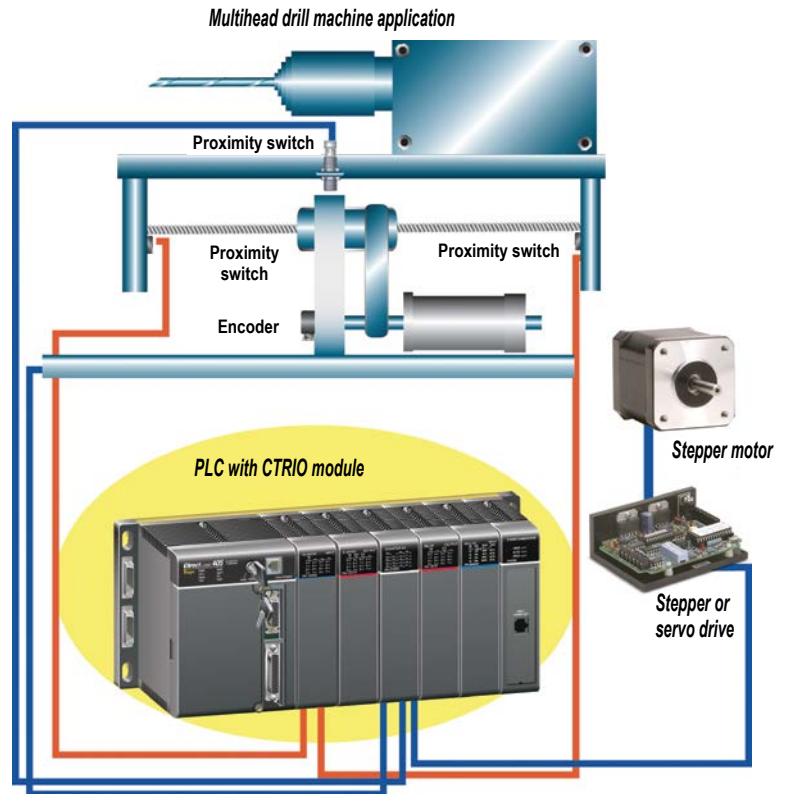
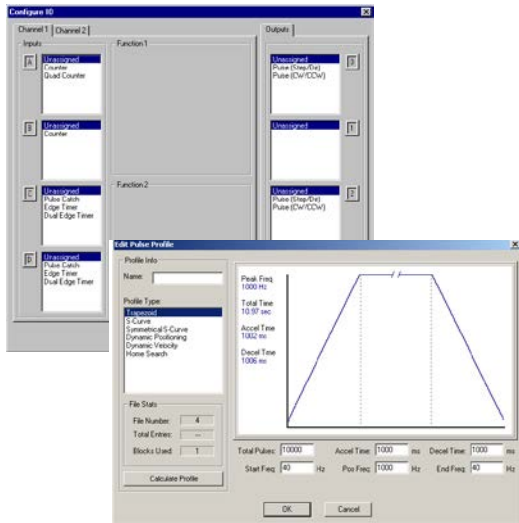

### High-Speed inputs and pulse output combinations

The flexible design of the CTRIO module allows for combining high-speed inputs and delivering high-speed pulse outputs signals simultaneously. There are limitations to this type of configuration in that the module does not internally support closed loop control. Providing closed loop control with the CTRIO involves additional PLC code to coordinate this control, making the application subject to the PLC CPU program scan. Simple position/speed monitoring via a high-speed counting input for non-critical response while providing pulse outputs to a drive is easily achievable for the CTRIO.

### Example application

In the simple drill-head application shown above, the CTRIO pulse outputs are wired to a stepper and/or servo drive. The inputs are wired to an encoder attached to the lead screw on the movable portion of the drill-head assembly. The CTRIO module output pulse train to the drive allows the motor to spin the lead screw making the drill move forward into the passing material. The encoder monitors the speed and position of the drill-head. Prox switches at each end act as limit switches ensuring the drill-head will not over-travel. A home sensor is positioned in the middle of the assembly which allows the PLC to reset the count.

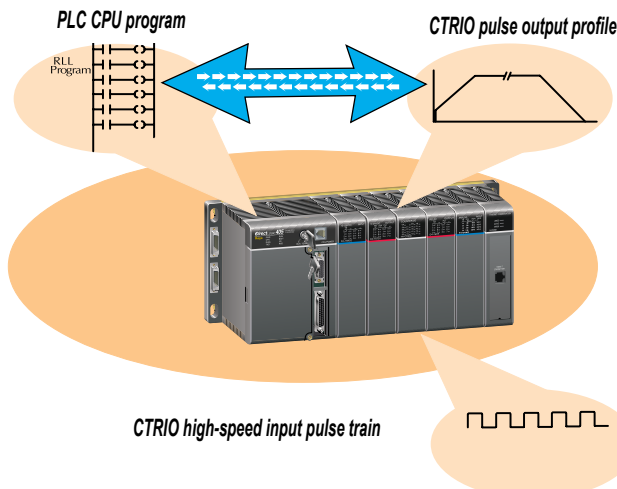

Closed loop control for the CTRIO module requires PLC CPU program interaction to close the loop. This makes the application subject to the PLC CPU scan.



# Check the Power Budget

## Verify your power budget requirements

Your I/O configuration choice can be affected by the power requirements of the I/O modules you choose. When determining the types and quantity of I/O modules you will be using, it is important to remember there is a limited amount of power available from the power supply.

The chart on the opposite page indicates the power supplied and used by each DL405 device. The adjacent chart shows an example of how to calculate the power used by your particular system. These two charts should make it easy for you to determine if the devices you have chosen fit within the power budget of your system configuration.

If the I/O you have chosen exceeds the maximum power available from the power supply, you can resolve the problem by shifting some of the modules to an expansion base or remote I/O base (if you are using remote I/O).

*Warning: It is extremely important to calculate the power budget correctly. If you exceed the power budget, the system may operate in an unpredictable manner which may result in a risk of personal injury or equipment damage.*

## Use ZIPLinks to reduce power requirements

If your application requires a lot of relay outputs, consider using the Ziplink AC or DC relay output modules. These modules can switch high current (10A) loads without putting a load on your base power budget. Refer to Wiring System for DL405 PLCs later in this section for more information.

This logo is placed next to I/O modules that are supported by the Ziplink connection systems.



See the I/O module specifications at the end of this section.

## Calculating your power usage

The following example shows how to calculate the power budget for the DL405 system. The example is constructed around a single 8-slot base using the devices shown. It is recommended you construct a similar table for each base in your system.

| A  |  |                    |                       |                                   |
|--|--|--------------------|-----------------------|-----------------------------------|
|  | <b>Base Number</b><br>0                  | <b>Device Type</b> | <b>5 VDC (mA)</b>     | <b>External 24 VDC Power (mA)</b> |
| <b>B</b>   | <b>CURRENT SUPPLIED</b>                  |                    |                       |                                   |
|  | <b>CPU/Expansion Unit /Remote Server</b> | D4-454 CPU         | 3700                  | 400                               |
| <b>C</b>   | <b>CURRENT REQUIRED</b>                  |                    |                       |                                   |
|  | <b>SLOT 0</b>                            | D4-16ND2           | +150                  | +0                                |
|  | <b>SLOT 1</b>                            | D4-16ND2           | +150                  | +0                                |
|  | <b>SLOT 2</b>                            | F4-04DA-2          | +90                   | +90                               |
|  | <b>SLOT 3</b>                            | D4-08NA            | +100                  | +0                                |
|  | <b>SLOT 4</b>                            | D4-08NA            | +100                  | +0                                |
|  | <b>SLOT 5</b>                            | D4-16TD2           | +100                  | +0                                |
|  | <b>SLOT 6</b>                            | D4-16TD2           | +100                  | +0                                |
|  | <b>SLOT 7</b>                            | D4-16TR            | +1000                 | +0                                |
| <b>D</b>   | <b>OTHER</b>                             |                    |                       |                                   |
|  | <b>BASE</b>                              | D4-08B-1           | +80                   | +0                                |
|  | <b>Handheld Programmer</b>               | D4-HPP-1           | +320                  | +0                                |
| <b>E</b>   | <b>Maximum Current Required</b>          |                    | <b>2190</b>           | <b>90</b>                         |
| <b>F</b>   | <b>Remaining Current Available</b>       |                    | <b>3700-2190=1510</b> | <b>400-90=310</b>                 |
| 1. Using a chart similar to the one above, fill in column 2.<br>2. Using the tables on the opposite page, enter the current supplied and used by each device (columns 3 and 4). Pay special attention to the current supplied by the CPU, Expansion Unit, and Remote Server since they differ. Devices which fall into the "Other" category (Row D) are devices such as the Base and the Handheld programmer, which also have power requirements, but do not plug directly into the base.<br>3. Add the current used by the system devices (columns 3 and 4) starting with Slot 0 and put the total in the row labeled "maximum current required" (Row E).<br>4. Subtract the row labeled "Maximum current required" (Row E), from the row labeled "Current Supplied" (Row B). Place the difference in the row labeled "Remaining Current Available" (Row F).<br>5. If "Maximum Current Required" is greater than "Current Supplied" in either column 3 or 4, the power budget will be exceeded. It will be unsafe to use this configuration and you will need to restructure your I/O configuration. Note the auxiliary 24VDC power supply does not need to supply all the external power. If you need more than the 400mA supplied, you can add an external 24VDC power supply. This will help keep you within your power budget for external power. |  |                    |                       |                                   |

## DL405 CPU power supply specifications and power requirements

| Specification                         | AC Powered Units   | 24 VDC Powered Units                           |
|---------------------------------------|--|--|
| <b>Part Numbers</b>                   | D4-454,<br>D4-EX (expansion base unit),<br>D4-RS (remote Server unit)        | D4-454DC-1, D4-EXDC (expansion base unit)      |
| <b>Voltage Withstand (dielectric)</b> | 1 minute @ 1,500 VAC between primary, secondary, field ground, and run relay |  |
| <b>Insulation Resistance</b>          | > 10MΩ at 500VDC   |  |
| <b>Input Voltage Range</b>            | 85-132 VAC (110V range)<br>170-264 VAC (220V range)                          | 20-28 VDC (24VDC)<br>with less than 10% ripple |
| <b>Maximum Inrush Current</b>         | 20A  | 20A  |
| <b>Maximum Power</b>                  | 50VA   | 38W  |

# Power Requirements

| Power Supplied                       |                                 |                                       |                                       |                              |                                    |
|--------------------------------------|---------------------------------|---------------------------------------|---------------------------------------|------------------------------|------------------------------------|
| CPUs/RemoteUnits/<br>Expansion Units | 5 VDC Current Supplied<br>in mA | 24V Aux Power<br>Supplied in mA       | CPUs/Remote Units/<br>Expansion Units | 5V Current Supplied in<br>mA | 24V Aux Power<br>Supplied in mA    |
| D4-454 CPU<br>D4-454DC-1             | 3100<br>3100                    | 400<br>NONE                           | D4-EX<br>D4-EXDC<br>D4-RS<br>H4-EBC   | 4000<br>4000<br>3700<br>3470 | 400<br>NONE<br>400<br>400          |
| Power Consumed                       |                                 |                                       |                                       |                              |                                    |
| Power-consuming Device               | 5V Current<br>Consumed          | External 24VDC<br>Current<br>Required | Power-consuming Device                | 5V Current<br>Consumed       | External 24VDC<br>Current Required |
| <b>I/O Bases</b>                     |                                 |                                       | <b>Analog Modules (continued)</b>     |                              |                                    |
| D4-04B-1                             | 80                              | NONE                                  | F4-16AD-1                             | 75                           | 100                                |
| D4-06B-1                             | 80                              | NONE                                  | F4-16AD-2                             | 75                           | 100                                |
| D4-08B-1                             | 80                              | NONE                                  | F4-08DA-1                             | 70                           | 75+20 per circuit                  |
| <b>DC Input Modules</b>              |                                 |                                       | F4-08DA-2                             | 90                           | 90                                 |
| D4-16ND2                             | 150                             | NONE                                  | F4-04DAS-1                            | 60                           | 60 per circuit                     |
| D4-16ND2F                            | 150                             | NONE                                  | F4-08DA-1                             | 90                           | 100+20 per circuit                 |
| D4-32ND3-1                           | 150                             | NONE                                  | F4-08DA-2                             | 80                           | 150                                |
| D4-64ND2                             | 300 max.                        | NONE                                  | F4-16DA-1                             | 90                           | 100+20 per circuit                 |
| <b>AC Input Modules</b>              |                                 |                                       | F4-16DA-2                             | 80                           | 25 max.                            |
| D4-08NA                              | 100                             | NONE                                  | F4-08RTD                              | 80                           | NONE                               |
| D4-16NA                              | 150                             | NONE                                  | F4-08THM-J(-n)                        | 120                          | 50                                 |
| <b>AC/DC Input Modules</b>           |                                 |                                       | F4-08THM                              | 110                          | 60                                 |
| D4-16NE3                             | 150                             | NONE                                  | <b>Remote I/O</b>                     |                              |                                    |
| <b>DC Output Modules</b>             |                                 |                                       | H4-ERM100                             | 320(300)                     | NONE                               |
| D4-16TD1                             | 200                             | 125                                   | H4-ERM-F                              | 450                          | NONE                               |
| D4-16TD2                             | 400                             | NONE                                  | D4-RM                                 | 300                          | NONE                               |
| D4-32TD1                             | 250                             | 140                                   | <b>Communications and Networking</b>  |                              |                                    |
| D4-32TD2                             | 350                             | 120 (4A max<br>including loads)       | H4-ECOM100                            | 300                          | NONE                               |
| D4-64TD1                             | 800                             | NONE                                  | D4-DCM                                | 500                          | NONE                               |
| <b>AC Output Modules</b>             |                                 |                                       | F4-MAS-MB                             | 235                          | NONE                               |
| D4-08TA                              | 250                             | NONE                                  | <b>CoProcessors</b>                   |                              |                                    |
| D4-16TA                              | 450                             | NONE                                  | F4-CP128-1                            | 305                          | NONE                               |
| <b>Relay Output Modules</b>          |                                 |                                       | <b>Specialty Modules</b>              |                              |                                    |
| D4-08TR                              | 550                             | NONE                                  | H4-CTRIO                              | 400                          | NONE                               |
| F4-08TRS-1                           | 575                             | NONE                                  | D4-16SIM                              | 150                          | NONE                               |
| F4-08TRS-2                           | 575                             | NONE                                  | F4-4LTC                               | 280                          | 75                                 |
| D4-16TR                              | 1000                            | NONE                                  | <b>Programming</b>                    |                              |                                    |
| <b>Analog Modules</b>                |                                 |                                       | D4-HPP-1 (Handheld Prog.)             | 320                          | NONE                               |
| F4-04AD                              | 150                             | 100                                   | <b>Operator Interface</b>             |                              |                                    |
| F4-04ADS                             | 370                             | 120                                   | C-more Micro-Graphic                  | 210                          | NONE                               |
| F4-08AD                              | 75                              | 90                                    |                                       |                              |                                    |