







# Pneumatic GVP Series Miniature Solenoid Valve Manifolds



NITRA manifolds designed to work with 15mm wide GVP series valves.

- Single to 4 stations
- #10-32 threaded or 1/8in NPT female ports
- Precision machined
- Compact
- Anodized aluminum for corrosion resistance
- Made in USA



Nitra Pneumatic GVP Series 15mm Miniature Solenoid Valve Manifolds					
Item	Part No.	Description	A inches [mm]	Price	Weight (lbs)
	<b><u>GM-321</u></b>	NITRA pneumatic valve manifold, anodized aluminum, rectangular, (1) station, #10-32 female threaded inlet(s), #10-32 female threaded outlet(s), #10-32 female threaded exhaust(s). For use with GVP-22 and GVP-32 series solenoid valves.	N/A	\$24.50	0.05
	<b><u>GM-322</u></b>	NITRA pneumatic valve manifold, anodized aluminum, rectangular, (2) stations, 1/8in female NPT inlet(s), #10-32 female threaded outlet(s), 1/8in female NPT exhaust(s). For use with GVP-22 and GVP-32 series solenoid valves.	2.13 [54.0]	\$31.00	0.15
	<b><u>GM-324</u></b>	NITRA pneumatic valve manifold, anodized aluminum, rectangular, (4) stations, 1/8in female NPT inlet(s), #10-32 female threaded outlet(s), 1/8in female NPT exhaust(s). For use with GVP-22 and GVP-32 series solenoid valves.	3.37 [85.7]	\$42.50	0.25
	<b><u>GM-321-18N</u></b>	NITRA pneumatic valve manifold, anodized aluminum, rectangular, (1) station, 1/8in female NPT inlet(s), 1/8in female NPT outlet(s), vent hole exhaust(s). For use with GVP-22 and GVP-32 series solenoid valves.	N/A	\$29.50	0.6

## Assembly Example

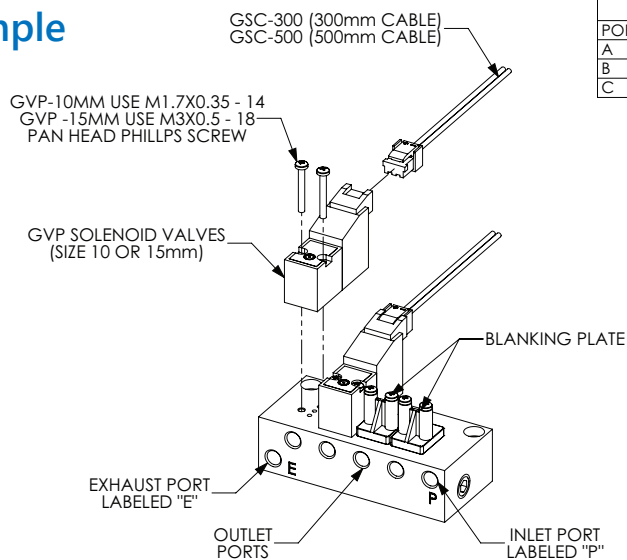

PORT	NC	NO
A	INPUT	EXHAUST
B	EXHAUST	INPUT
C	OUTPUT	OUTPUT

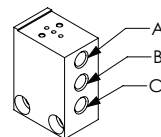

GM-311

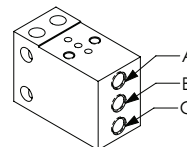

GM-321

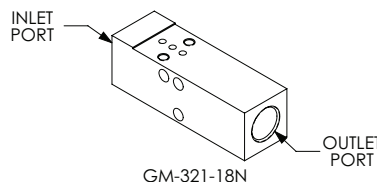

GM-321-18N



# Pneumatic GVP Series Miniature Solenoid Valve Manifolds

## Dimensions

mm [inches]

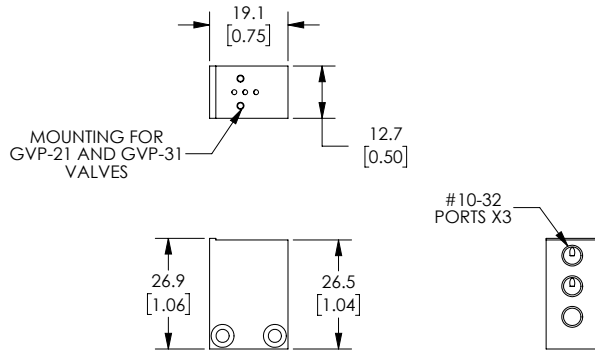

Part No. **GM-311**

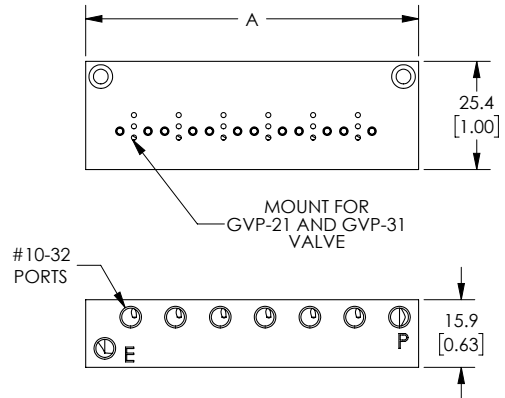

Part No. **GM-312, GM-314, GM-316**

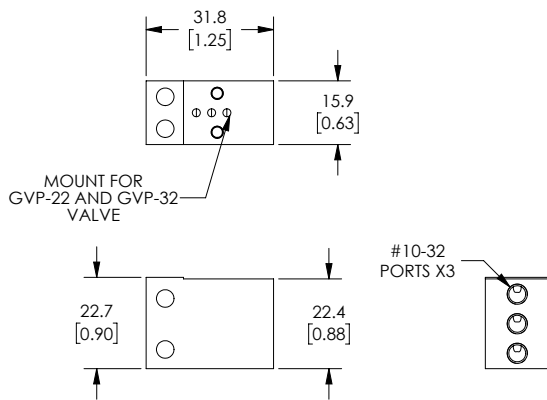

Part No. **GM-321**

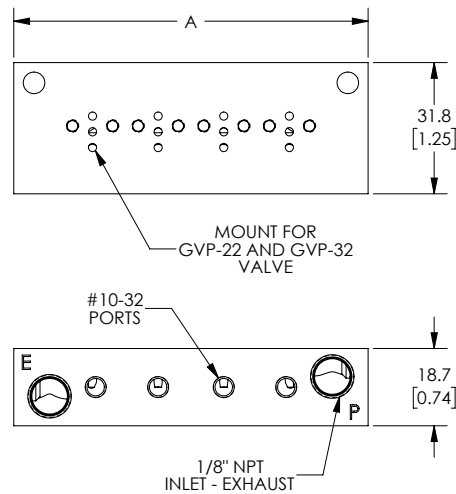

Part No. **GM-322, GM-324**

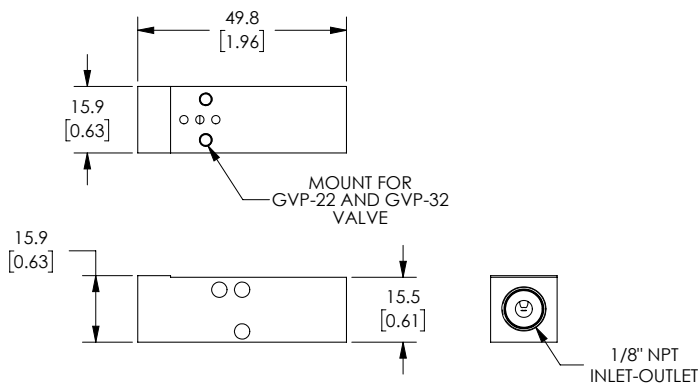





Part No. **GM-321-18N**

See our website [www.AutomationDirect.com](http://www.AutomationDirect.com) for complete Engineering drawings.



# Pneumatic GVP Series Miniature Solenoid Manifold Accessories



Nitra Pneumatic GVP Series Miniature Solenoid Valve Manifold Accessories				
Item	Part No.	Description	Price	Weight (lbs)
	<b><u>GM-31BP</u></b>	NITRA blanking plate, nylon. For use with GM-31 series manifolds. Gasket and mounting screws included.	\$6.00	0.05
	<b><u>GM-32BP</u></b>	NITRA blanking plate, nylon. For use with GM-32 series manifolds. Gasket and mounting screws included.	\$5.75	0.05
	<b><u>GSC-300</u></b>	NITRA solenoid valve cable, miniature pin plug to pigtail, 11.8in/300mm cable length. For use with GVP series solenoid valves.	\$5.75	0.05
	<b><u>GSC-500</u></b>	NITRA solenoid valve cable, miniature pin plug to pigtail, 19.6in/500mm cable length. For use with GVP series solenoid valves.	\$6.00	0.05

## Dimensions

mm [inches]

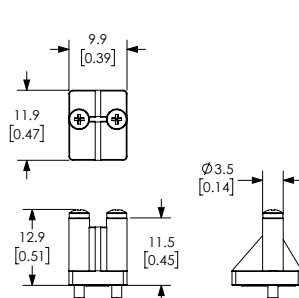

Part No. **GM-31BP**

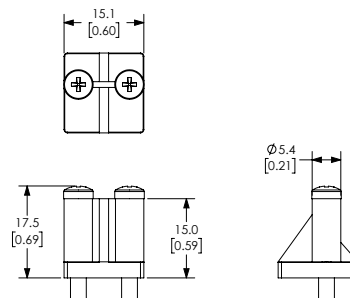

Part No. **GM-32BP**

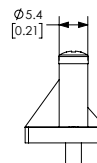

See our website [www.AutomationDirect.com](http://www.AutomationDirect.com) for complete Engineering drawings.