



Pneumatic GVP Series Miniature Latching Solenoid Valves



Part No. **GVP-311CL-24D**



Part No. **GVP-321CL-12D**

Diagram "A"

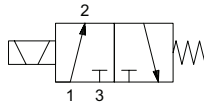

3-way, 2-position, Spring Return

NITRA pneumatic latching solenoid valves will stay open after being momentarily energized thus saving power consumption and reducing heat. Valves must be mounted to a GM-3 series manifold (sold separately).

Features

- 10mm and 15mm valve widths
- 3-way normally closed configuration
- Reversing polarity changes state
- GM-3 series manifolds sold separately



See www.AutomationDirect.com for a wide variety of fitting options

GVP Series Miniature Latching Solenoid Valves		
Model	<u>GVP-311CL-24D</u>	<u>GVP-321CL-12D</u>
Price	\$64.00	\$63.00
Weight (lbs)	0.05	0.1
Size	10mm	15mm
Valve Type	3-way, 2-position, Normally Closed	3-way, 2-position, Normally Closed
Acting	Single latching solenoid spring return poppet	
Diagram	A	A
Fluid	Air or Inert Gas (to be filtered by 40µ filter element)	
Min. / Max. Pressure	0 to 105 psi (0 to 7.24 bar)	
Flow (Cv)	0.013	0.047
Port	Requires GM type 10mm or 15mm manifolds for operation	
Voltage	24VDC	12VDC
Continuous ON Power	1.3 W	4 W
Expected Life	50,000,000 cycles at max 2 cycles/second	
Wiring	Connector Receptacle (Wire connector required)	18" Flying Leads
Response Time	6ms (on), 8ms (off)	
Indication	LED	No LED
Temperature - Operation and Storage	14~122°F (-10~50°C)	
Lubrication	Not Required	
Body	Glass-filled nylon	
Protection	n/a	



Pneumatic GVP Series Miniature Latching Solenoid Valves

Dimensions

mm [inches]

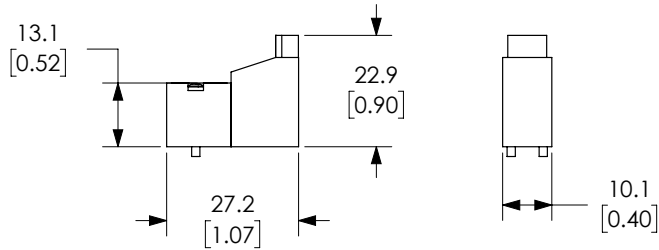

GVP-x11CL-xxD

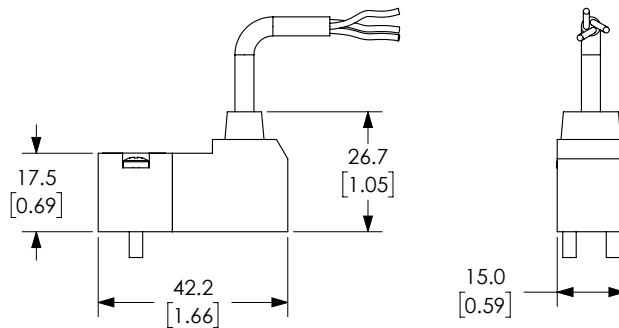

GVP-x21CL-xxD

See our website www.AutomationDirect.com for complete Engineering drawings.







Pneumatic GVP Series Miniature Solenoid Valve Manifolds



NITRA manifolds designed to work with 10mm wide GVP series valves.

- Single to 6 stations
- #10-32 female threaded ports
- Precision machined
- Compact
- Anodized aluminum for corrosion resistance
- Made in USA



Nitra Pneumatic GVP Series 10mm Miniature Solenoid Valve Manifolds					
Item	Part No.	Description	A inches [mm]	Price	Weight (lbs)
	GM-311	NITRA pneumatic valve manifold, anodized aluminum, rectangular, (1) station, #10-32 female threaded inlet(s), #10-32 female threaded outlet(s), #10-32 female threaded exhaust(s). For use with GVP-21 and GVP-31 series solenoid valves.	N/A	\$24.50	0.05
	GM-312	NITRA pneumatic valve manifold, anodized aluminum, white, rectangular, (2) stations, #10-32 female threaded inlet(s), #10-32 female threaded outlet(s), #10-32 female threaded exhaust(s). For use with GVP-21 and GVP-31 series solenoid valves.	1.42 [36.1]	\$34.00	0.05
	GM-314	NITRA pneumatic valve manifold, anodized aluminum, rectangular, (4) stations, #10-32 female threaded inlet(s), #10-32 female threaded outlet(s), #10-32 female threaded exhaust(s). For use with GVP-21 and GVP-31 series solenoid valves.	2.25 [78.2]	\$38.00	0.10
	GM-316	NITRA pneumatic valve manifold, anodized aluminum, rectangular, (6) stations, #10-32 female threaded inlet(s), #10-32 female threaded outlet(s), #10-32 female threaded exhaust(s). For use with GVP-21 and GVP-31 series solenoid valves.	3.08 [78.2]	\$45.00	0.15

Assembly Example

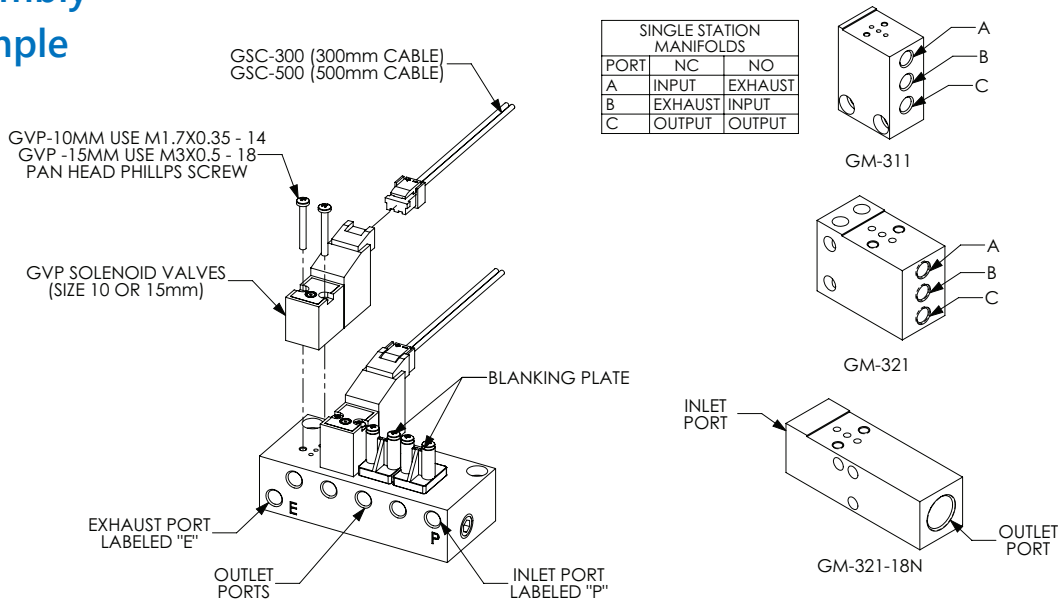







Pneumatic GVP Series Miniature Solenoid Valve Manifolds



NITRA manifolds designed to work with 15mm wide GVP series valves.

- Single to 4 stations
- #10-32 threaded or 1/8in NPT female ports
- Precision machined
- Compact
- Anodized aluminum for corrosion resistance
- Made in USA



Nitra Pneumatic GVP Series 15mm Miniature Solenoid Valve Manifolds					
Item	Part No.	Description	A inches [mm]	Price	Weight (lbs)
	<u>GM-321</u>	NITRA pneumatic valve manifold, anodized aluminum, rectangular, (1) station, #10-32 female threaded inlet(s), #10-32 female threaded outlet(s), #10-32 female threaded exhaust(s). For use with GVP-22 and GVP-32 series solenoid valves.	N/A	\$24.50	0.05
	<u>GM-322</u>	NITRA pneumatic valve manifold, anodized aluminum, rectangular, (2) stations, 1/8in female NPT inlet(s), #10-32 female threaded outlet(s), 1/8in female NPT exhaust(s). For use with GVP-22 and GVP-32 series solenoid valves.	2.13 [54.0]	\$31.00	0.15
	<u>GM-324</u>	NITRA pneumatic valve manifold, anodized aluminum, rectangular, (4) stations, 1/8in female NPT inlet(s), #10-32 female threaded outlet(s), 1/8in female NPT exhaust(s). For use with GVP-22 and GVP-32 series solenoid valves.	3.37 [85.7]	\$42.50	0.25
	<u>GM-321-18N</u>	NITRA pneumatic valve manifold, anodized aluminum, rectangular, (1) station, 1/8in female NPT inlet(s), 1/8in female NPT outlet(s), vent hole exhaust(s). For use with GVP-22 and GVP-32 series solenoid valves.	N/A	\$29.50	0.6

Assembly Example

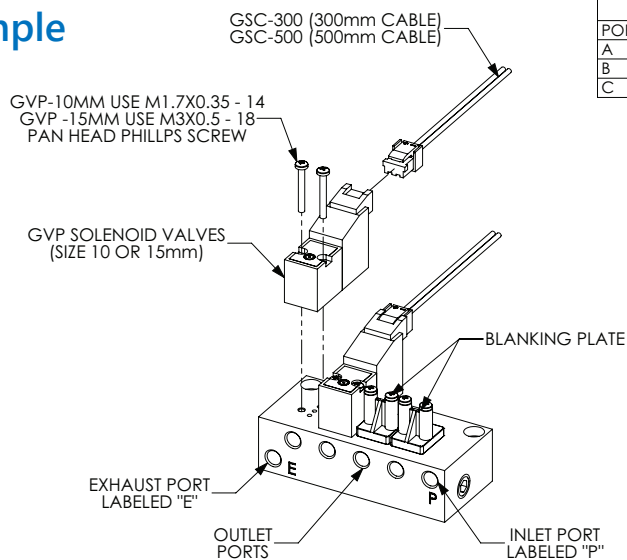

PORT	NC	NO
A	INPUT	EXHAUST
B	EXHAUST	INPUT
C	OUTPUT	OUTPUT

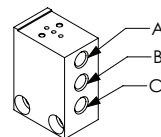

GM-311

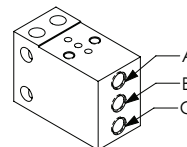

GM-321

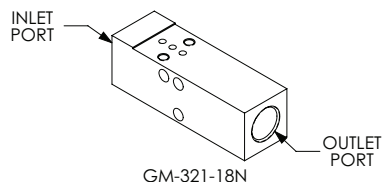

GM-321-18N



Pneumatic GVP Series Miniature Solenoid Valve Manifolds

Dimensions

mm [inches]

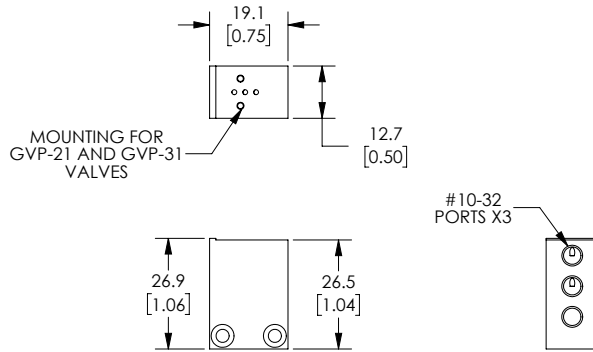

Part No. **GM-311**

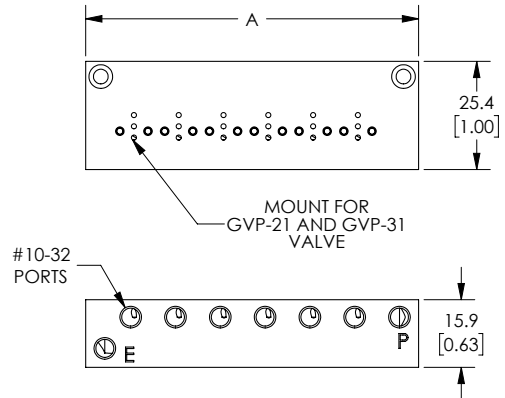

Part No. **GM-312, GM-314, GM-316**

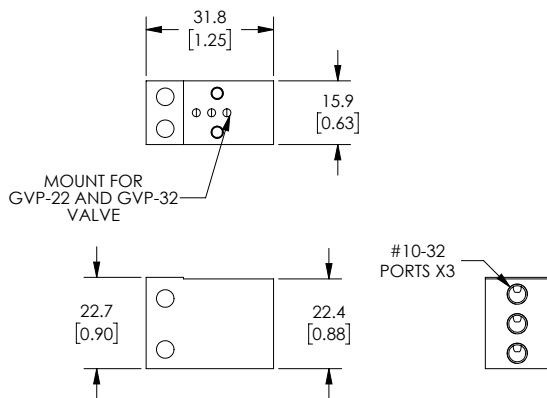

Part No. **GM-321**

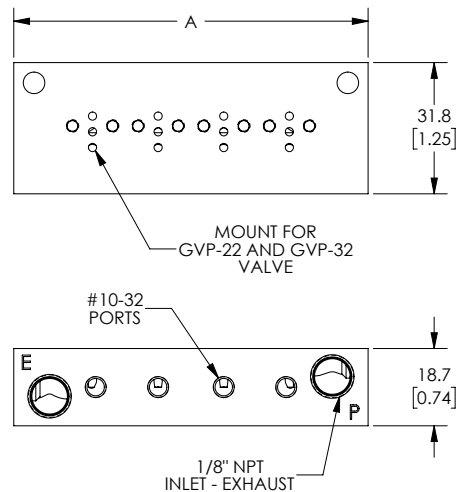

Part No. **GM-322, GM-324**

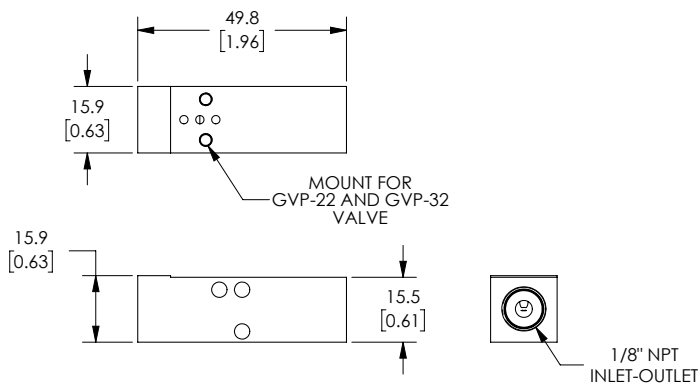





Part No. **GM-321-18N**

See our website www.AutomationDirect.com for complete Engineering drawings.



Pneumatic GVP Series Miniature Solenoid Manifold Accessories



Nitra Pneumatic GVP Series Miniature Solenoid Valve Manifold Accessories				
Item	Part No.	Description	Price	Weight (lbs)
	<u>GM-31BP</u>	NITRA blanking plate, nylon. For use with GM-31 series manifolds. Gasket and mounting screws included.	\$6.00	0.05
	<u>GM-32BP</u>	NITRA blanking plate, nylon. For use with GM-32 series manifolds. Gasket and mounting screws included.	\$5.75	0.05
	<u>GSC-300</u>	NITRA solenoid valve cable, miniature pin plug to pigtail, 11.8in/300mm cable length. For use with GVP series solenoid valves.	\$5.75	0.05
	<u>GSC-500</u>	NITRA solenoid valve cable, miniature pin plug to pigtail, 19.6in/500mm cable length. For use with GVP series solenoid valves.	\$6.00	0.05

Dimensions

mm [inches]

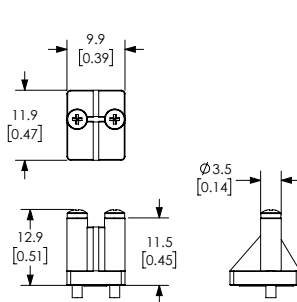

Part No. **GM-31BP**

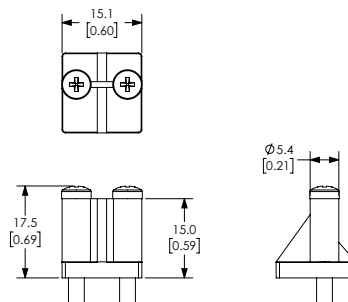

Part No. **GM-32BP**

See our website www.AutomationDirect.com for complete Engineering drawings.