

GS1, GS2, GS3/DURAPULSE Accessories – Software

Overview

GSoft, the configuration software for the GS1, GS2, GS3/DURAPULSE drives, allows a personal computer to be directly connected to the drives via RS-232 or RS-485 (PC serial port, USB-RS232, USB-485M, or customer supplied converter required). You can perform a variety of functions to allow easy, intuitive, and secure set-up of any application that is required using GSoft.

GSOFT is available as a free downloaded at: <http://support.automationdirect.com/products/gsoft.html>.

System Requirements

To run GSoft, your PC must meet the following requirements:

- Windows 95, 98, Me, NT, 2000, XP, or Windows 7
- Internet Explorer 4.0 or higher (for HTML help support)
- 24 Mb of available memory
- 8Mb hard drive space
- Available RS-232 serial port (or USB-RS232, USB-485M converters)

Features

- Create new drive configurations using one of three views:
 - Quick Start - Allows for just the basic set-up to get quick and simple applications up and running ASAP.
 - Detailed - The complete set-up of all parameters in the drive.
 - Schematic Views - Set up the drive using the interactive schematic view. Create a printable cad-like drawing at the same time for future documentation and maintenance-friendly activities.
- Upload/download drive configurations.
- Edit drive configuration .
- Archive/store multiple drive configurations on your PC .
- Trend drive operation parameters in real time.
- Maintenance keypad will allow the user to commission the drive from the PC, check rotation, and run a basic cycle.
- Live PID tuning with active tuning control. Take the difficulty out of PID tuning with a real time trend.
- View drive faults.
- OPC Server over the Ethernet with the GS-EDRV100 option card

GS1, GS2, GS3/DURAPULSE AC Drive Software		
Part Number	Price	Description
GSOFT *	Free	configuration software*
USB-485M	\$60.00	USB to RS-485 converter
GS-232CBL	Retired	RS-232 cable
USB-RS232	\$47.00	USB to RS232 converter

* GSOFT can be used with GS1, GS2, & GS3/DURAPULSE drives; USB-485M or FA-ISOCAN required for GS1 and GS3/DURAPULSE drives.
* GSOFT can be downloaded for free: www.automationdirect.com

GSoft offers three software configuration methods

Detailed Configuration

The Detailed Configuration method provides AC drive parameter access in a tabbed dialog format. Detailed Configuration can be used for new or existing configurations.

Schematic View Configuration

The Schematic View Configuration method uses a schematic picture of the AC drive and external connections to guide you through the setup of the AC drive. The Schematic View method can be used for new or existing configurations.

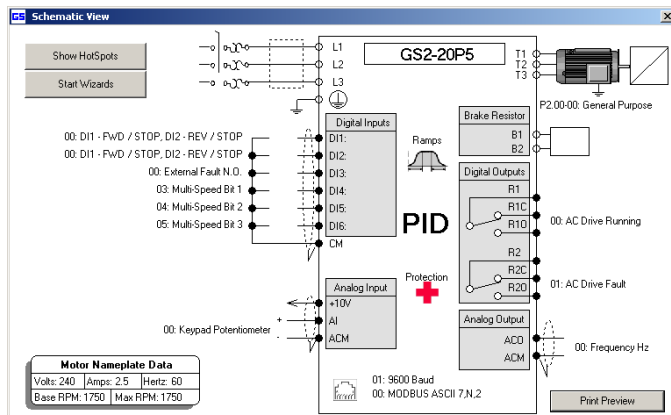
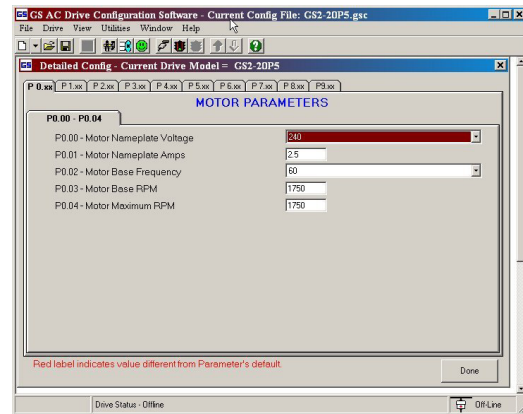

Quick Start Configuration

The Quick Start Configuration method guides you through the most commonly used AC drive parameters. Quick Start Configuration may ONLY be used to create a new configuration. Once created and saved, subsequent editing is done using the Detailed or Schematic View methods.

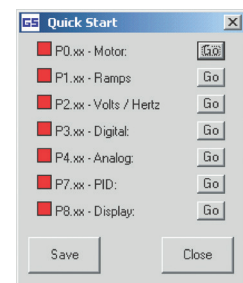

GS1,GS2,GS3/DURAPULSE Accessories – Miscellaneous



GS3-KPD



ZL-CDM-RJ12x4



ZL-CDM-RJ12x10

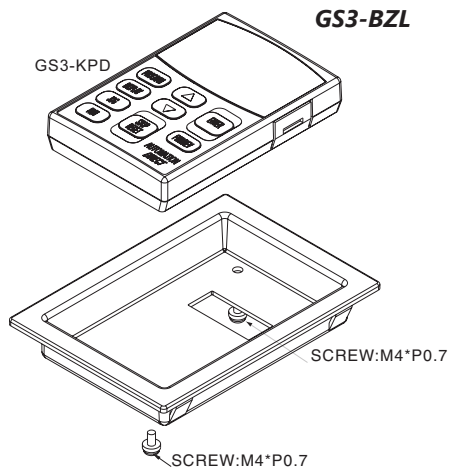

GS3-BZL

The GS3-BZL Flush Mount Bezel Kit allows remote mounting of the DURApulse removable keypad. The Bezel Kit has a Protected Chassis, IP20 enclosure rating. The thickness of the panel will determine required hole dimensions:

t = 1.0 (.0393) - 1.4 (.0551) t = 1.6 (.629) - 2.0 (.0787) t = 2.2 (.0866) - 3.0 (.1181)

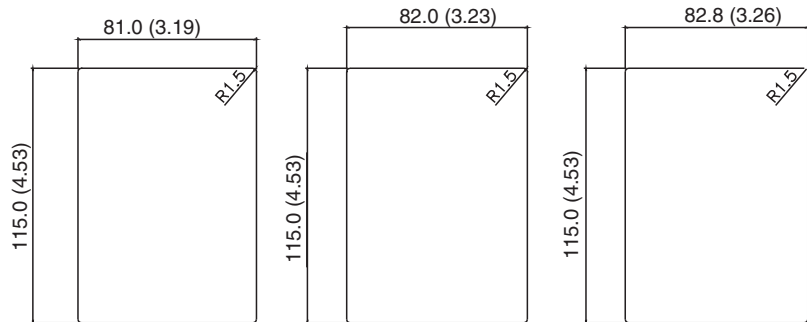

GS-CBL2-1L



GS-CBL2-3L



GS-CBL2-5L

GS1, GS2, GS3/DURApulse Drives Miscellaneous Accessories			
Part Number	Drive Model	Description	Price
GS-232CBL	GS2 DURApulse	Configuration Cable required for GSoft configuration software	Retired
GS-CBL2-1L	GS2, GS3/DURApulse	One meter keypad cable (installation screws included)	\$18.00
GS-CBL2-3L	GS2, GS3/DURApulse	Three meter keypad cable (installation screws included)	\$23.50
GS-CBL2-5L	GS2, GS3/DURApulse	Five meter keypad cable (installation screws included)	\$28.00
GS3-KPD	GS3/DURApulse	Spare or replacement keypad for DURApulse AC drives; great for maintenance or back-up programs	Retired
GS3-BZL	GS3/DURApulse	Flush Mount Bezel Kit for remote mounting of the DURApulse removable keypad	\$16.00
ZL-CDM-RJ12X4	GS1, GS2, GS3/DURApulse	ZIPLink 4-port communication distribution module, 4 RJ12 ports, and 1 screw terminal port	\$29.00
ZL-CDM-RJ12X10	GS1, GS2, GS3/DURApulse	ZIPLink 10-port communication distribution module, 10 RJ12 ports, and 1 screw terminal port	\$36.50

Optional ZipLink serial communication cables available for plug and play connectivity to AutomationDirect PLCs. See the comm cable selection matrix on page [pg.tGSX-182](#).