

DURAPULSE GS4 AC Drives – Optional GS4-Specific Internal Accessories List

Accessories Available for GS4 AC Drives Only

GS4 AC Drives Software and Accessories Internal or Attached to GS4 Drive										
Model Number	Frame Size	GS4 Drive Software	GS4 PLC Software	Drive Keypad*	Keypad Mounting Bezel	I/O Modules	Communication Modules	Conduit Boxes	Cooling Fans*	Flange Mount Kits
		pg.tGSX-110	pg.tGSX-111	pg.tGSX-112	pg.tGSX-112	pg.tGSX-108	pg.tGSX-109	pg.tGSX-115	230V pg.tGSX-113 460V pg.tGSX-114	pg.tGSX-116
GS4-21P0	A							n/a	n/a	GS4-FMKIT-A
GS4-22P0										GS4-FMKIT-1
GS4-23P0									GS4-FAN-AM	GS4-FMKIT-A
GS4-25P0										GS4-FMKIT-A
GS4-27P5	B							n/a	GS4-FAN-BM1 GS4-FAN-BB	GS4-FMKIT-B
GS4-2010									GS4-FAN-BM2 GS4-FAN-BB	
GS4-2015										
GS4-2020	C							n/a	GS4-FAN-CM GS4-FAN-CB1	GS4-FMKIT-C
GS4-2025										
GS4-2030	D**							GS4-CBX-D	GS4-FAN-DM GS4-FAN-DB	n/a
GS4-2040										
GS4-2050	E**							GS4-CBX-E	GS4-FAN-EM1 GS4-FAN-EB	n/a
GS4-2060							GS4-FAN-EM2 GS4-FAN-EB			
GS4-2075										
GS4-2100	A	GSOFT2	GSLOGIC	GS4-KPD	GS4-BZL	GS4-06CDD GS4-06NA GS4-06TR	GS4-CM-ENETIP GS4-CM-MODTCP	n/a	n/a	GS4-FMKIT-A
GS4-41P0										GS4-FMKIT-1
GS4-42P0										GS4-FMKIT-A
GS4-43P0										
GS4-45P0										
GS4-47P5										
GS4-4010	B							n/a	GS4-FAN-BM1 GS4-FAN-BB	GS4-FMKIT-B
GS4-4015									GS4-FAN-BM2 GS4-FAN-BB	
GS4-4020	C							n/a	GS4-FAN-CM GS4-FAN-CB2	GS4-FMKIT-C
GS4-4025										
GS4-4030										
GS4-4040	D0**							GS4-CBX-D0	GS4-FAN-D0M GS4-FAN-DB	n/a
GS4-4050										
GS4-4060	D**							GS4-CBX-D	GS4-FAN-DM GS4-FAN-DB	n/a
GS4-4075										
GS4-4100	E**							GS4-CBX-E	GS4-FAN-EM2 GS4-FAN-DB	n/a
GS4-4125										
GS4-4150	F**							GS4-CBX-F	GS4-FAN-FM GS4-FAN-FB	n/a
GS4-4175										
GS4-4200	G							GS4-CBX-G	GS4-FAN-GM	n/a
GS4-4250										
GS4-4300										

* Keypads and Cooling Fans are pre-installed and included with the GS4 Drives.
They are field-replaceable and available for purchase separately as spare or replacement parts.
** GS4 drives in D0, D, E and F frames can be flanged mounted and do not require a flange mount kit.

 Note: Refer to the page numbers shown above for more complete information about the accessory products.

GS4-Specific Optional Accessories – Input/Output Expansion Cards

Accessories Applicable Only to GS4 AC Drives

Please refer to the "GS/DURApulse AC Drives – Accessories" section for accessories applicable to multiple families of GS/DURApulse AC Drives, including GS4.

Input/Output Expansion Cards

Optional I/O cards allow additional inputs and outputs to be added to the GS4 internal I/O. (Only one I/O card can be installed at a time.)

GS4 DURAPULSE Drives Input/Output Expansion Cards							
Part Number	Price	Description	Terminals	Specifications	Wire Size	Placement*	GS Drive
GS4-06CDD*	\$33.50	DURAPULSE combination discrete I/O module, selectable sinking or sourcing 24VDC input, 24VDC output, 4-point input, 2-point output, 1 input common(s), 1 output common(s), 50mA resistive output current.	COM	(1) Common for Input Terminals	20~24 AWG	slot #3	GS4 – all
			DI10–DI13	(4) Discrete Inputs; selectable sinking or sourcing Internal power available: 24VDC ±5% 200mA, 5W External power: 24VDC (30V max, 19V min), 30W ON: activation 6.5mA @ ≥ 9VDC OFF: leakage 10µA ≤ 3VDC			
			DO10–DO11	(2) Discrete Outputs (photocoupler) Duty-cycle: 50% Max. output frequency: 100Hz Max. current: 50mA resistive Max. voltage: 48VDC			
			DOC	(1) Common for Output Terminals			
GS4-06NA*	\$36.00	DURAPULSE discrete input module, sinking 120VAC input, 6-point input, 1 input common(s).	ACN	(1) AC power common for Input Terminal (Neutral)	20~24 AWG	slot #3	GS4 – all
			DI10–DI15	(6) Discrete Inputs; sinking Input voltage: 100–130 VAC Input frequency: 47–63 Hz Input impedance: 27kΩ Terminal response time: ON: 10ms OFF: 20ms			
GS4-06TR*	\$55.00	DURAPULSE relay output module, Form A (SPST-NO) relays, 6-point output, 6 output common(s), 3 Amps resistive output current, 1.2 Amps inductive output current, 250VAC/30VDC input.	R10–R15	(6) separate commons for each relay	20~26 AWG	slot #3	GS4 – all
			RO10–RO15	(6) normally open relay output Resistive load: 5A(NO) / 250VAC 5A(NO) / 30VDC Inductive load (COSØ 0.4) 2A(NO) / 250VAC			

* GS4 AC drives have three option card slots; each slot will hold only one option card designed for that particular slot. I/O cards are designed for slot #3, and will not fit in any other slot.

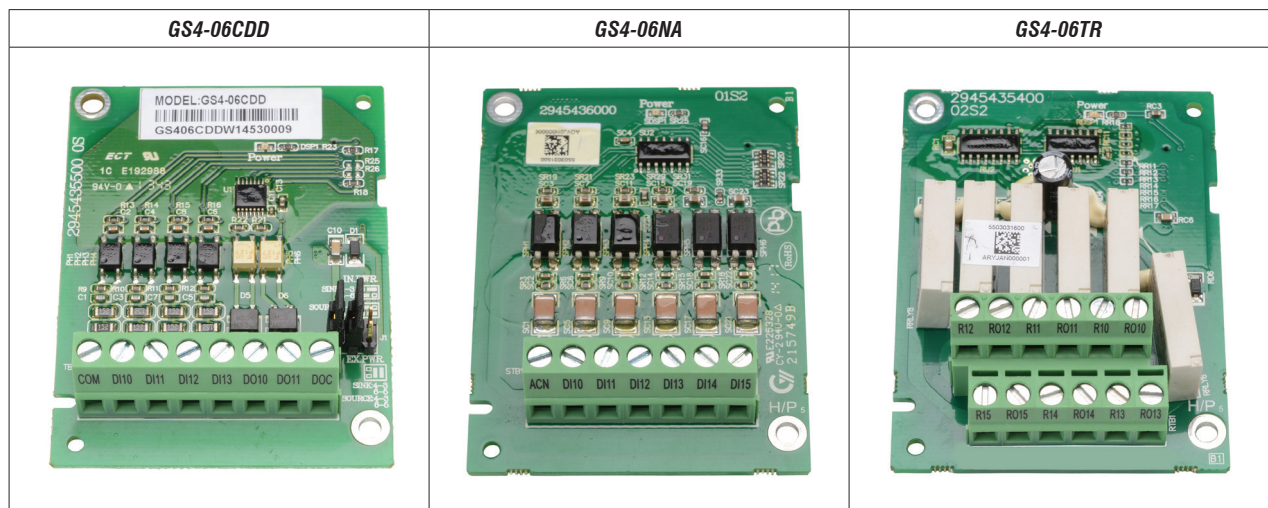

GS4-Specific Optional Accessories – Communication Interface Cards

Accessories Applicable Only to GS4 AC Drives

Please refer to the "GS/DURApulse AC Drives – Accessories" section for accessories applicable to multiple families of GS/DURApulse AC Drives, including GS4.

Communication Cards

Communication interface cards provide EtherNet/IP™ or ModbusTCP communication capability. Only one communication card can be installed at a time.

GS4 DURAPULSE Drives Communication Interface Cards					
Part Number	Price	Description	Specifications	Placement*	GS Drive
GS4-CM-ENETIP*	\$110.00	DURAPULSE communication card, EtherNet/IP	Interface: EtherNet/IP RJ45 with MDI/MDIX auto-detect Number of ports: 1 (16 connections max) Transmission method: IEEE 802.3, IEEE 802.3u Transmission cable: Category 5e shielding 100MHz Transmission speed: 10/100 Mbps Auto-Detect Network protocol: ICMP, IP, TCP, UDP, DHCP, Modbus TCP, EtherNet/IP Power supply voltage: 5VDC (supplied by the GS4 AC drive) Insulation voltage: 500VDC Power consumption: 0.8W Weight: 25g Noise immunity ESD (IEC 61800-5-1, IEC 61000-4-2) EFT (IEC 61800-5-1, IEC 61000-4-4) Surge Test (IEC 61800-5-1, IEC 61000-4-5) Conducted Susceptibility Test (IEC 61800-5-1, IEC 61000-4-6) Operation: -10°C to +50°C [14°F to 122°F] (temperature), 90% (humidity) Storage: -25°C to +70°C [-13°F to +158°F] (temperature), 95% (humidity) Vibration / Shock immunity: IEC 61800-5-1, IEC 60068-2-6/IEC 61800-5-1, IEC 60068-2-27 Ethernet timeout functionality for EtherNet/IP connections GS4-CM-ENETIP supports 4 EtherNet/IP connections and also supports 4 ModTCP connections. These ModTCP connections cannot start/stop or change command frequency in the drive, but can be used to monitor the drive and change Parameters. Ethernet timeout functionality <u>for ModTCP connections</u> is <u>not</u> supported on the EtherNet/IP card.	slot #1	GS4 – all
GS4-CM-MODTCP*	\$97.00	DURAPULSE communication card, ModbusTCP	Interface: Ethernet RJ45 with MDI/MDIX auto-detect Number of ports: 1 (4 connections max) Transmission method: IEEE 802.3, IEEE 802.3u Transmission cable: Category 5e shielding 100MHz Transmission speed: 10/100 Mbps Auto-Detect Network protocol: ICMP, IP, TCP, UDP, DHCP, Modbus TCP Power supply voltage: 5VDC (supplied by the GS4 AC drive) Insulation voltage: 500VDC Power consumption: 0.8W Weight: 25g Noise immunity ESD (IEC 61800-5-1, IEC 61000-4-2) EFT (IEC 61800-5-1, IEC 61000-4-4) Surge Test (IEC 61800-5-1, IEC 61000-4-5) Conducted Susceptibility Test (IEC 61800-5-1, IEC 61000-4-6) Operation: -10°C to +50°C [14°F to 122°F] (temperature), 90% (humidity) Storage: -25°C to +70°C [-13°F to +158°F] (temperature), 95% (humidity) Vibration / Shock immunity: IEC 61800-5-1, IEC 60068-2-6/IEC 61800-5-1, IEC 60068-2-27 Ethernet Timeout functionality for ModTCP connections	slot #1	GS4 – all

* GS4 AC drives have three option card slots; each slot will hold only one option card designed for that particular slot. Communication interface cards are designed for slot #1, and will not fit in any other slot.

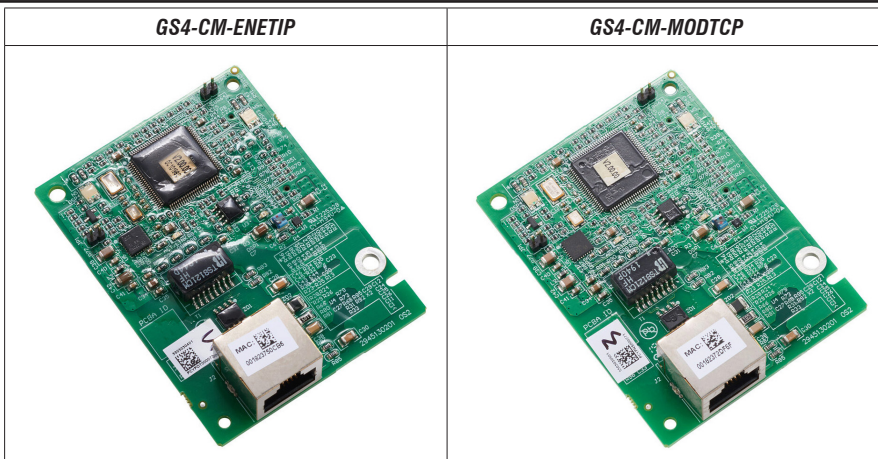

DuraPulse Accessories – Software

GSoft2 Drive Configuration Software

GSoft2 Drive Configuration Software

Available for *FREE* Download

DURAPULSE Drives GSOFT2 Drive Configuration Software			
Part Number	Price*	Description	For GS Drive
GSOFT2	\$10.50	GSOFT2 Windows configuration software, USB or free download. For use with DURApulse GS4, GS10, GS20, GS20X and GS30 series AC drives. Requires PC serial port or USB-485M serial adapter.	GS4 – all GS10 – all GS20(X) – all GS30 – all
USB-485M	\$60.00	PC adapter, USB A to RS-485 (RJ45/RJ12).	GS4/GS10
USB-CBL-AB3	\$12.00	Programming cable, USB A to USB B, 3ft cable length.	GS4 – all (for Drive FW only) GS20(X) – all GS30 – all
* GSOFT2 can be downloaded for <u>free</u> or purchased on USB from AutomationDirect.com (search for GSOFT2).			

GSOFT2 Drive Configuration Software

GSoft2 is the configuration software for the Automation DuraPulse family of drives. It is designed to allow you to connect a personal computer to the drive, and perform a variety of functions.

GSoft2 includes an integral help file with software instructions. GSoft2 can be downloaded for free or purchased on USB from AutomationDirect.com (search for GSoft2).

Functions

- Create new drive configurations
- Upload/download drive configurations
- Edit drive configurations
- Archive/store multiple drive configurations on your PC
- Trend drive operation parameters (not available with GS10)
- Tune the drive PID loop
- View real time key operating parameters
- Real-time trending
- Start/Stop drive and switch directions, provided drive is set up for remote operation
- View drive faults

Computer System Requirements

GSoft2 will run on Windows PCs that meet the following requirements:

- Windows OS: **8**: 32 & 64 bit, **8.1**: 32 & 64 bit, **10**: 64 bit, 11
- Edge or Chrome (for HTML help support)
- 32 Mb of available memory
- 10 Mb hard drive space
- Available USB port
- USB to RS485 adapter needed for GS4 and GS10 models



GS4/GS20(X)/GS30 Accessories – Software GSLogic PLC Programming Software

Optional Accessory Software Applicable Only to AC Drive Series:

- GS4
- GS20(X)
- GS30

GSLOGIC Drive Configuration Software

Available for *FREE* Download

GS4/GS20(X)/GS30 DURAPULSE Drives GSLogic PLC Programming Software			
Part Number	Price*	Description	For GS Drive
GSLOGIC	\$10.50	GSLOGIC Windows logic software, USB or free download. For use with DURApulse GS4, GS20, GS20X and GS30 series AC drives. Requires PC serial port or USB-485M serial adapter.	GS4 - all GS20(X) – all GS30 – all
USB-485M	\$60.00	PC adapter, USB A to RS-485 (RJ45/RJ12).	GS4 – all
USB-CBL-AB3	\$12.00	Programming cable, USB A to USB B, 3ft cable length.	GS20(X) – all GS30 – all

* GSLOGIC can be downloaded for free or purchased on USB from AutomationDirect.com (search for GSLOGIC).

PLC Summary

The GS4, GS20(X), and GS30 drives include a built-in PLC. Programmed in ladder logic, the PLC provides a comprehensive set of instructions and 2,000 (GS20(X)), 5,000 (GS30), or 10,000 (GS4) steps of programming capacity. GSLogic PLC software includes a Help File which contains the detailed information needed to use the PLC.

The PLC functionality is included with every GS4, GS20(X), and GS30 drive, and can be accessed over communications by external PLCs (via serial Modbus), or by the drive itself (using built-in PLC instructions). The PLC is perfectly suited for applications where digital and analog I/O requirements are small. For applications with complex PLC programming or large I/O requirements, please consider Click, Productivity, or Do-More/BRX. All of these PLCs can be easily integrated with the GS drive family or PLC. The GS4-KPD keypad is capable of storing multiple PLC programs.

There are two methods for communicating from the PLC to the drive. The first method is to use the WPR and RPR instructions available in the PLC's library. These two instructions can read from or write to any AC drive parameter in the same physical drive. The second method is to use Modbus RTU. The PLC is a Serial Modbus slave only. A Modbus RTU master can communicate with the PLC via serial only; optional communication cards cannot address the PLC. If communication cards (EtherNet/IP or Modbus TCP) are the desired method of communication, the drive includes PLC Buffers parameters that can be used. Simply write the needed information from the PLC into the drive's PLC buffer parameters using the WPR instruction. The Modbus TCP or EtherNet/IP cards can then read the VFD parameters.

GSLogic Introduction

GSLogic is the drive PLC programming software for the AutomationDirect GS4, GS20(X), and GS30 family of drives. It is designed to enable you to perform a variety of drive PLC programming functions. Windows editing functions like cut, copy, paste, multiple windows, etc., are supported. GSLogic also provides for register editing, settings, file reading, saving, online monitoring settings, and other convenience functions, such as:

- Upload/download drive PLC program files to the onboard PLC
- Create new drive PLC programs
- Edit drive PLC programs
- Archive/store multiple drive PLC programs on your PC or the GS4-KPD drive keypad
- Control drive PID loops (FPID instructions)
- View in real time all drive PLC registers
- Print drive PLC program files

GSLogic includes an integral help file that includes software instructions, how to use GSLogic, and how to use the GS drive PLC.

GSLogic System Requirements

GSLogic is a Windows-based programming software environment. Please check the following requirements when choosing your PC configuration:

- Windows OS: **8**: 32 & 64 bit, **8.1**: 32 & 64 bit, **10**: 64 bit, **11**
- 300MB free hard-disk space
- USB Port required for project transfer to drive
- USB-485M serial adapter required for GS4 models

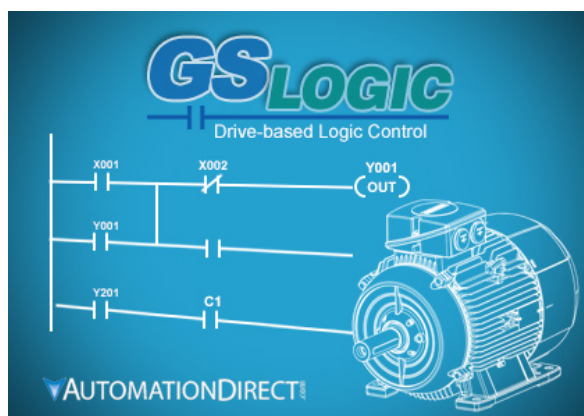

DuraPulse Optional Accessories – Advanced LCD Keypad

Advanced Keypad

NOTE: The keypad described below is included with the GS4 AC Drive, and is also available for purchase separately as a spare/replacement component for GS4, or an optional upgrade for GS10/GS20(X)/GS30.

Keypad Panel-Mounting Kit

NOTE: The keypad panel-mounting kit described below is an optional accessory that is NOT included with the GS10/GS20(X)/GS30 AC drive.

GSx Series DURAPULSE Drives Keypad and Keypad Panel-Mounting Kit			
Part Number	Price	Description	For GS Drive
GS4-KPD*	\$107.00	Spare or replacement keypad for GS4 AC drives; optional advanced keypad for GS20(X) drives; includes RJ45 connector; great for maintenance or back-up programs.	GS4 – all GS10 – all GS20(X) – all GS30 – all
GS4-BZL**	\$29.50	Keypad Panel-Mounting Kit for remote surface mounting or embedded mounting of the AC drive removable keypad; hardware included. Use a standard Cat5e RJ45 patch cable (not included) to connect a remote-mounted keypad to the drive. Max cable length for remote-mounted keypad = 5m.	GS4 – all GS10 – all GS20(X) – all GS30 – all

* A keypad is included with each GS4 AC Drive; additional keypads are available for spare/replacement components.
 ** The keypad mounting kit is an optional accessory that is NOT included with the GS4 AC drive; for mounting the keypad remotely from the drive.
 Note: Keypad firmware can only be upgraded when connected to a GS4 drive.

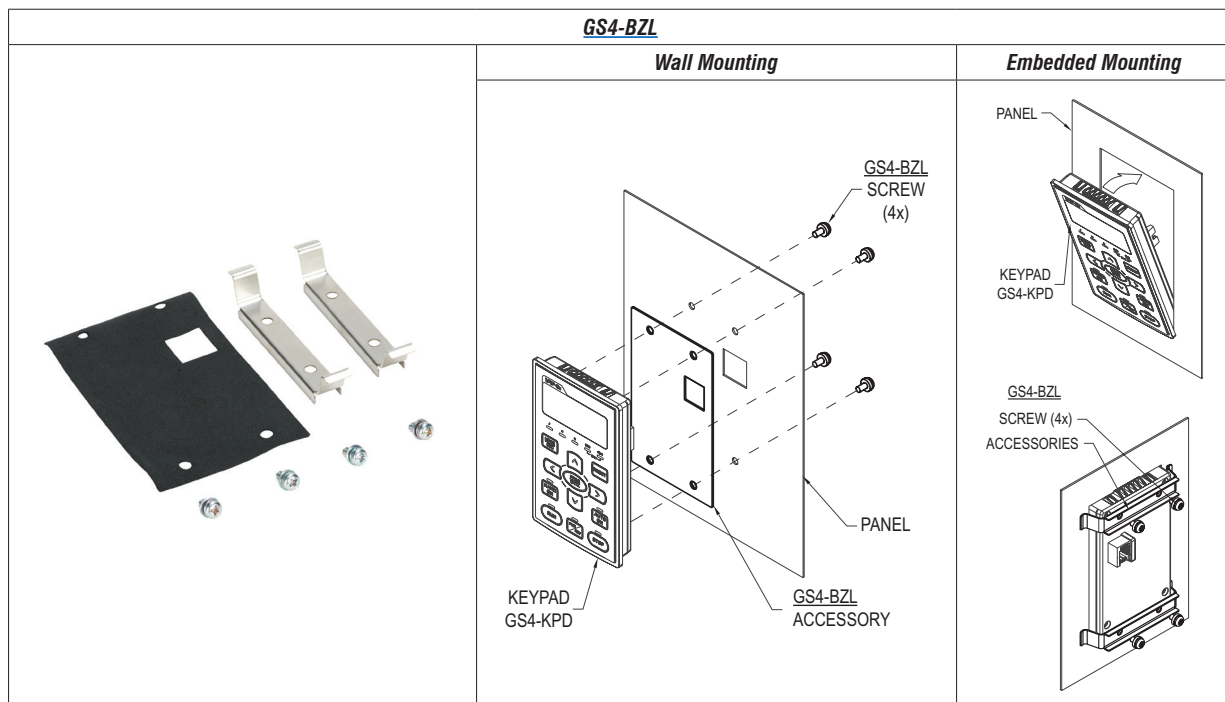
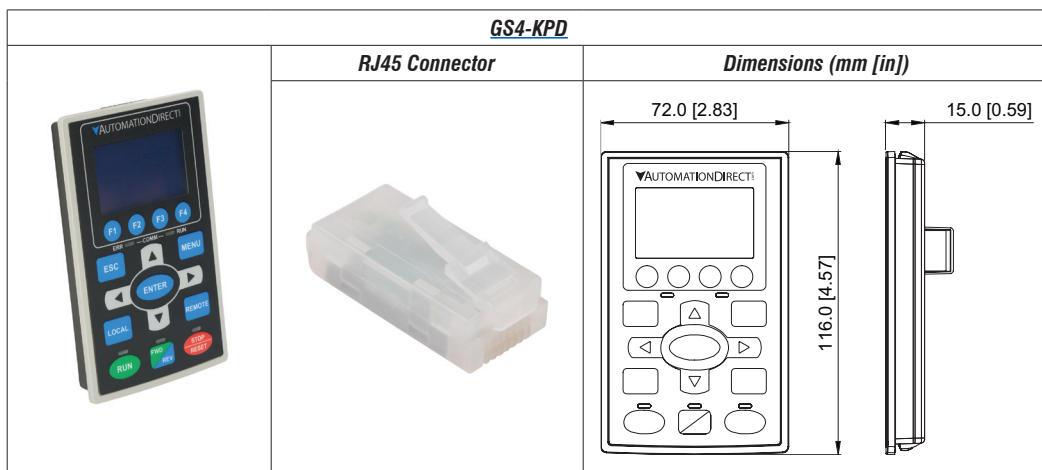

GS4-Specific Optional Accessories – Spare/Replacement Cooling Fans

Accessories Applicable Only to GS4 AC Drives

Please refer to the "GS/DURApulse AC Drives – Accessories" section for accessories applicable to multiple families of GS/DURApulse AC Drives, including GS4.

Cooling Fans for 230V GS4 Drives (Spare/Replacement)

NOTE: The fans described below are included with the applicable GS4 AC Drive, and are also available for purchase separately as spare/replacement components.

GS4 230V Models – (GS4-2xxx) – Fan Selection Table								
Drive Model	Fan Model *			Description	Size	Voltage	Amps / Fan	Fans / Kit
	Part #	Price	Photo					
GS4-22P0 GS4-23P0 GS4-25P0	<u>GS4-FAN-AM</u>	\$28.00		Frame A main	40mm	24	0.15	1
GS4-27P5	<u>GS4-FAN-BM1</u>	\$34.50		Frame B main	80mm	24	0.33	1
	<u>GS4-FAN-BB</u>	\$27.00		Frame B board level	40mm	24	0.18	1
GS4-2010 GS4-2015	<u>GS4-FAN-BM2</u>	\$52.00		Frame B main	80mm	24	0.51	1
	<u>GS4-FAN-BB</u>	\$27.00		Frame B board level	40mm	24	0.18	1
GS4-2020 GS4-2025 GS4-2030	<u>GS4-FAN-CM</u>	\$49.00		Frame C main	92mm	24	0.75	1
	<u>GS4-FAN-CB1</u>	\$28.00		Frame C board level	40mm	24	0.18	1
GS4-2040 GS4-2050	<u>GS4-FAN-DM</u>	\$174.00		Frame D main	92mm	24	0.75	2
	<u>GS4-FAN-DB</u>	\$58.00		Frame D board level	70mm	24	0.33	1
GS4-2060 GS4-2075	<u>GS4-FAN-EM1</u>	\$239.00		Frame E main	120mm	24	1.08	2
	<u>GS4-FAN-EB</u>	\$119.00		Frame E board level	120mm	24	0.76	1
GS4-2100	<u>GS4-FAN-EM2</u>	\$303.00		Frame E main	92mm 120mm 120mm	24	0.75 1.08 1.08	3
	<u>GS4-FAN-EB</u>	\$119.00		Frame E board level	120mm	24	0.76	1

* These fans are included with the GS4 drive, and also available separately as spare or replacement components. Electrical connectors are included.

GS4-Specific Optional Accessories – Spare/Replacement Cooling Fans

Accessories Applicable Only to GS4 AC Drives

Please refer to the "GS/DURApulse AC Drives – Accessories" section for accessories applicable to multiple families of GS/DURApulse AC Drives, including GS4.

Cooling Fans for 460V GS4 Drives (Spare/Replacement)

NOTE: The fans described below are included with the applicable GS4 AC Drive, and are also available for purchase separately as spare/replacement components.

GS4 460V Models – (GS4-4xxx) – Fan Selection Table								
Drive Model	Fan Model *			Description	Size	Voltage	Amps / Fan	Fans / Kit
	Part #	Price	Photo					
GS4-43P0 GS4-45P0 GS4-47P5	GS4-FAN-AM	\$28.00		Frame A main	40mm	24	0.15	1
GS4-4010	GS4-FAN-BM1	\$34.50		Frame B main	80mm	24	0.33	1
	GS4-FAN-BB	\$27.00		Frame B board level	40mm	24	0.18	1
GS4-4015 GS4-4020	GS4-FAN-BM2	\$52.00		Frame B main	80mm	24	0.51	1
	GS4-FAN-BB	\$27.00		Frame B board level	40mm	24	0.18	1
GS4-4025 GS4-4030 GS4-4040	GS4-FAN-CM	\$49.00		Frame C main	92mm	24	0.75	1
	GS4-FAN-CB2	\$34.50		Frame C board level	40mm	12	0.60	1
GS4-4050 GS4-4060	GS4-FAN-DM0	\$98.00		Frame D0 main	80mm	24	0.75	2
	GS4-FAN-DB	\$58.00		Frame D board level	70mm	24	0.33	1
GS4-4075 GS4-4100	GS4-FAN-DM	\$174.00		Frame D main	92mm	24	0.75	2
	GS4-FAN-DB	\$58.00		Frame D board level	70mm	24	0.33	1
GS4-4125 GS4-4150	GS4-FAN-EM2	\$303.00		Frame E main	92mm 120mm 120mm	24	0.75 1.08 1.08	3
	GS4-FAN-EB	\$119.00		Frame E board level	120mm	24	0.76	1
GS4-4175 GS4-4200	GS4-FAN-FM	\$431.00		Frame F main	92mm	24	0.76	4
	GS4-FAN-FB	\$126.00		Frame F board level	120mm	24	1.08	1
GS4-4250 GS4-4300	GS4-FAN-GM	\$902.00		Frame G main	250mm	48	2.2	2

* These fans are included with the GS4 drive, and also available separately as spare or replacement components. Electrical connectors are included.

GS4-Specific Optional Accessories – Conduit Boxes





Accessories Applicable Only to GS4 AC Drives

Please refer to the “GS/DURApulse AC Drives – Accessories” section for accessories applicable to multiple families of GS/DURApulse AC Drives, including GS4.

Conduit Boxes

Optional Conduit Box Kits can be ordered separately. These kits bolt onto the bottom of the applicable GS4 drive to provide a convenient connection point for conduit entry, allowing the GS4 to maintain a IP20/NEMA 1 environmental protection rating; especially useful for GS4 drives mounted outside of an electrical control panel.

Note: GS4 Frames A through C have integral conduit box space built into the drive. No separate conduit boxes are necessary or available.

GS4 Frame Sizes D0–G – Conduit Box Selection Table					
Drive		Conduit Box **			Description
Model	Frame*	Part #	Price	Photo	
GS4-4060, GS4-4050	D0	<u>GS4-CBX-D0</u>	\$163.00		NEMA 1 conduit box kit for use with GS4 frame size D0 AC drive; mounting hardware included
GS4-2040, GS4-2050; GS4-4075, GS4-4100	D	<u>GS4-CBX-D</u>	\$163.00		NEMA 1 conduit box kit for use with GS4 frame size D AC drive; mounting hardware included
GS4-2060, GS4-2075, GS4-2100; GS4-4125, GS4-4150	E	<u>GS4-CBX-E</u>	\$188.00		NEMA 1 conduit box kit for use with GS4 frame size E AC drive; mounting hardware included
GS4-4150, GS4-4200	F	<u>GS4-CBX-F</u>	\$271.00		NEMA 1 conduit box kit for use with GS4 frame size F AC drive; mounting hardware included
GS4-4250, GS4-4300	G	<u>GS4-CBX-G</u>	\$513.00		NEMA 1 conduit box kit for use with GS4 frame size G AC drive; mounting hardware included





* GS4 Frame Sizes A through C have integral conduit box space built into the drive; separate conduit boxes are not necessary nor available.
 ** Conduit Box Kits include mounting hardware; box base, box cover, bushings, and screws.
 Conduit box dimensions are shown with the AC drive dimensions, as mounted on the drive.

GS4-Specific Optional Accessories – Flange Mounting Kits

Flange Mounting Kits

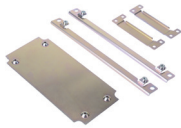
Optional GS4 drive flange mounting kits allow the heat sinks on the back of select GS4 drives to be positioned through the back of the control enclosure. Since a majority of the heat generated by the GS4 drive will be outside the enclosure, heat load will be reduced and a smaller enclosure may possibly be used. These flange mounting kits are applicable to GS4 drive frame sizes A through C.

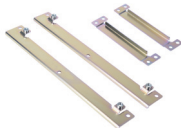
NOTE: GS4 Frames D0, D, E, and F have integral flange mounting hardware; additional Flange Mounting Kit not required (see cutout dimensions below).
Frame size G cannot be flange-mounted.

GS4 Frame Sizes A–C – Flange Mounting Kit Selection Table					
Drive		Flange Mounting Kit **			Description
Model	Frame*	Part #	Price	Photo	
GS4-22P0 GS4-23P0 GS4-43P0	A	<u>GS4-FMKIT-1</u>	\$74.00		GS4 series Flange Mounting Kit, NEMA 1; for use with multiple GS4 Frame A drives; adapter plate and mounting hardware included
GS4-21P0 GS4-25P0 GS4-41P0 GS4-42P0 GS4-45P0 GS4-47P5	A	<u>GS4-FMKIT-A</u>	\$62.00		GS4 series Flange Mounting Kit, NEMA 1; for use with multiple GS4 Frame A drives; mounting hardware included
GS4-27P5 GS4-2010 GS4-2015 GS4-4010 GS4-4015 GS4-4020	B	<u>GS4-FMKIT-B</u>	\$70.00		GS4 series Flange Mounting Kit, NEMA 1; for use with GS4 Frame B drives; mounting hardware included
GS4-2020 GS4-2025 GS4-2030 GS4-4025 GS4-4030 GS4-4040	C	<u>GS4-FMKIT-C</u>	\$79.00		GS4 series Flange Mounting Kit, NEMA 1; for use with GS4 Frame C drives; mounting hardware included

* See panel cutout dimensions below for GS4 Frames A, B, C.
* GS4 Frames D0, D, E, and F have integral flange mounting hardware; additional Flange Mounting Kit not required. See Appendix A of the GS4 User Manual for panel cut-out dimensions for frames D0, E, F.
* Frame size G cannot be flange-mounted.

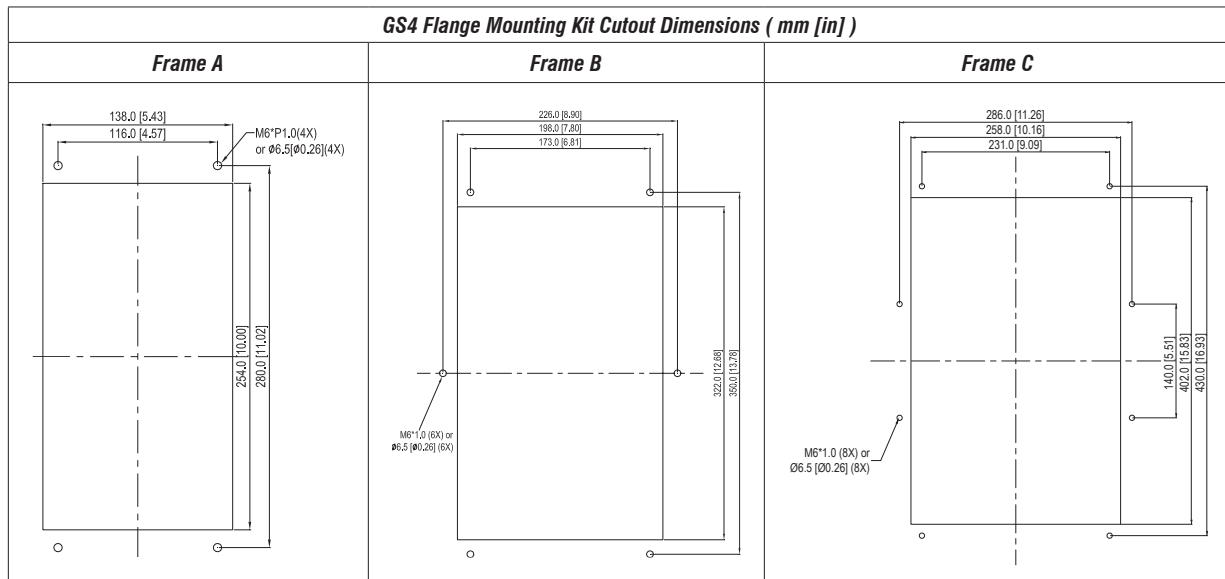

DURAPULSE GS4 AC Drives Specifications – Installation

Understanding the installation requirements for your DURAPULSE AC drive will help to ensure that it operates within its environmental and electrical limits.

Note: Never use only this catalog for installation instructions or operation of equipment; refer to the User Manual, GS4_UMW.

Environmental Conditions for GS4 AC Drives			
Condition	Operation	Storage	Transportation
Installation Location	IEC60364-1/IEC60664-1 Pollution degree 2, Indoor use only	n/a	n/a
Ambient Temperature	see separate Operating Temperature table below		
Relative Humidity	Max 90%, non-condensing, non-frozen	Max 95%, non-condensing, non-frozen	
Air Pressure	86 to 106 kPa		70 to 106 kPa
Pollution Level	IEC721-3-3, no concentrate		
	Class 3C2; Class 3S2	Class 2C2; Class 2S2	Class 1C2; Class 1S2
Altitude	0–1000m (see separate derating section for altitudes of 1000–3000m)	n/a	n/a
Package Drop	n/a	ISTA procedure 1A (according to weight) IEC60068-2-31	
Vibration	1.0mm, peak to peak value range from 2Hz to 13.2Hz; 0.7G–1.0G range from 13.2Hz to 55Hz; 1.0G range from 55Hz to 512Hz. Comply with IEC 60068-2-6		
Impact	IEC/EN 60068-2-27		
Installation Orientation	<div style="text-align: center;"> <p>Max allowed offset angle $\pm 10^\circ$ (from vertical installation position)</p> </div>		

Operating Temperature and Protection Level					
Frame Size	Top cover	Conduit Box	Protection Level	Operating Temperature	
A–C	230V: 1.0–30 hp 460V: 1.0–40 hp	With top cover removed	Standard conduit plate	IP20 / UL Open Type	-10–50°C [14–122°F]
		With top cover in place		IP20 / UL Type1 / NEMA 1	-10–40°C [14–104°F]
D0–G	230V: >30hp 460V: >40hp	N/A	With conduit box	IP20 / UL Type1 / NEMA 1	-10–40°C [14–104°F]
	230V: >30hp 460V: >40hp	N/A	Without conduit box	IP00 / IP20 / UL Open Type * Only the circled area is IP00. Other parts are IP20.	-10–50°C [14–122°F]

* Only the exposed terminal blocks are IP00; the other components are IP20



WARNING: AC DRIVES GENERATE A LARGE AMOUNT OF HEAT WHICH MAY DAMAGE THE AC DRIVE. AUXILIARY COOLING METHODS MAY BE REQUIRED TO AVOID EXCEEDING MAXIMUM OPERATING TEMPERATURE. WHEN POSSIBLE, CONSIDER FLANGE MOUNTING TO LOWER ENCLOSURE TEMPERATURES.



WARNING: MAXIMUM AMBIENT TEMPERATURES MUST NOT EXCEED 50°C (122°F), OR 40°C (104°F), FOR ALL GS4 MODELS.

DURAPULSE GS4 AC Drives Specifications – Air Flow and Power (Heat) Dissipation

GS4 AC Drives Air Flow and Power (Heat) Dissipation									
Model Number	Airflow Rate ¹⁾ for Cooling						Power (Heat) Dissipation ²⁾		
	Flow Rate ¹⁾ (cfm)			Flow Rate ¹⁾ (m ³ /hr)			Power Dissipation ²⁾ (Watt)		
	External	Internal	Total	External	Internal	Total	External (Heat sink)	Internal	Total
GS4-21P0	–	–	–	–	–	–	33	27	60
GS4-22P0	14	–	14	24	–	24	56	31	87
GS4-23P0	14	–	14	24	–	24	79	36	115
GS4-25P0	10	–	10	17	–	17	113	46	159
GS4-27P5	40	14	54	68	24	92	197	67	264
GS4-2010	66	14	80	112	24	136	249	86	335
GS4-2015	58	14	73	99	24	123	409	121	530
GS4-2020	166	12	178	282	20	302	455	161	616
GS4-2025	166	12	178	282	20	302	549	184	733
GS4-2030	166	12	178	282	20	302	649	216	865
GS4-2040	179	30	209	304	51	355	913	186	1099
GS4-2050	179	30	209	304	51	355	1091	220	1311
GS4-2060	228	73	301	387	124	511	1251	267	1518
GS4-2075	228	73	301	387	124	511	1401	308	1709
GS4-2100	246	73	319	418	124	542	1770	369	2139
GS4-41P0	–	–	–	–	–	–	33	25	58
GS4-42P0	–	–	–	–	–	–	45	29	74
GS4-43P0	14	–	14	24	–	24	71	33	104
GS4-45P0	10	–	10	17	–	17	103	38	141
GS4-47P5	10	–	10	17	–	17	134	46	180
GS4-4010	40	14	54	68	24	92	216	76	292
GS4-4015	66	14	80	112	24	136	287	93	380
GS4-4020	58	14	73	99	24	123	396	122	518
GS4-4025	99	21	120	168	36	204	369	138	507
GS4-4030	99	21	120	168	36	204	476	158	634
GS4-4040	126	21	147	214	36	250	655	211	866
GS4-4050	179	30	209	304	51	355	809	184	993
GS4-4060	179	30	209	304	51	355	929	218	1147
GS4-4075	179	30	209	304	51	355	1156	257	1413
GS4-4100	186	30	216	316	51	367	1408	334	1742
GS4-4125	257	73	330	437	124	561	1693	399	2092
GS4-4150	223	73	296	379	124	503	2107	491	2598
GS4-4175	224	112	336	381	190	571	2502	579	3081
GS4-4200	289	112	401	491	190	681	3096	687	3783
GS4-4250			454			771			4589
GS4-4300			454			771			5772

The required airflow shown in chart is for installing a single GS4 drive in a confined space. When installing multiple GS4 drives, the required air volume would be the cumulative air volume for all drives in the enclosure.

Heat dissipation shown in the chart is for installing a single GS4 drive in a confined space. When installing multiple drives, the volume of heat dissipation should be the cumulative heat dissipation of all drives in the enclosure. Heat dissipation for each model is calculated by rated voltage, current and default carrier frequency.

- 1) External flow rate is across the heat sink. Internal flow rate is through the chassis. Published flow rates are the result of active cooling using fans; factory-installed in the drive. Unpublished flow rates (-) are the result of passive cooling in drives without factory-installed fans.
- 2) When calculating power dissipation (Watt Loss) use the total value if the drive is foot mounted, or the internal value if the drive is flange mounted. Where only a total value is published, these models cannot be flange mounted.

Dimensions for Minimum Clearance * (mm / in)				
Frame Size	Above & Below	Side to Non-Heat Source	Side to Heat Source	Front
A–C	60 / 2.4	30 / 1.2	10 / 0.4	0 / 0
D(0)–F	100 / 4.0	50 / 2.0	n/a	0 / 0
G	200 / 7.9	100 / 4.0	2 x B	0 / 0

* The minimum mounting clearances stated in this table applies to GS4 drives frames A to G. Failure to follow the minimum mounting clearances may cause the fan to malfunction and cause a heat dissipation problem.