

UL 489 or UL 1077? What are your Circuit Protection Requirements?

An understanding of circuit types and circuit protection products is critical to ensure their proper application.
See NEC Sections 100, 430 and 409 for definitions.

The proper sizing of an overcurrent protection device is the responsibility of the customer and should be determined using the application standards of the NEC (National Electric Code), CEC (Canadian Electrical Code) or other applicable standards. Per fine print note of 2008 NEC Section 100 "A current in excess of rating may be accommodated by certain equipment and conductors for a given set of conditions. Therefore, the rules for overcurrent protection are specific for particular situations."

UL 489

Branch Protection

UL 1077

Supplementary Protection



What You Need to Know and Look For In Specifications

Certifications – Standards – Acceptance

UL 489 Branch Protection

- UL 489 Listed or Recognized
- CSA C22.2 No. 5
- International ratings available depending on breaker type

UL 1077 Supplementary Protection

- UL Recognized under UL 1077
- CSA 22.2 No. 285
- IEC 60947-2 or IEC 898

Function

- Opens automatically on Overload and Short Circuit when properly applied within its ratings
- Protects wire and cable against Overload and Short Circuit

- Opens automatically on Overload and Short Circuit
- Provides additional equipment protection where branch circuit protection is already provided or not required
- Not suitable for the protection of branch circuit conductors

Applications

- Branch circuit protection in control panels, panelboards, switchboards and motor control centers
- Motor overload and motor short circuit protection (UL 489 Recognized motor circuit protectors) for control panels and motor control centers

- Used within appliances or other electrical equipment such as control circuits, control power transformers, relays, PLC I/O points and lighting circuits
- Ideal replacement for fuses that are applied as supplementary protection

Features

- Bolted down or DIN rail mounted
- External handle mechanisms available
- Field mounted accessories
- Stand alone branch circuit protection
- Various levels of protection (curve type)
- High voltage and interruption levels (up to 100 kAIC @ 480V)

- DIN rail mounted
- Field mounted accessories
- Various levels of protection (curve type)
- 10 kAIC @ 240 VAC
- 10 kAIC @ 277 VAC and 5 kAIC @ 480VAC
- 10 kAIC @ 48VDC

kAIC = thousands of Amps interrupt capacity

Summary

A Supplementary Protector can't be used for Branch Circuit Protection.
Understanding the difference between Branch Circuit Protection and Supplementary Protection helps to ensure their proper use.

Gladiator
from AutomationDirect

Miniature Circuit Breakers (UL 489)



Single-Pole



Two-Pole



Three-Pole

Overview

Gladiator miniature circuit breakers offer optimum and efficient protection for branch and control circuits up to 63 amps. The Gladiator series is available with B, C or D trip characteristics in accordance with UL 489. The Gladiator series units are DIN rail mountable and can be used in feeder and branch circuit applications.

Listings

- UL Listed under UL 489 Category DIVQ E503708
- Category DIHS E509077
- CE LVD 2014/35/EU
- IEC/EN 60947-2

Features and Benefits

- Dual rated for AC or DC applications
- Complete range of UL 489 listed DIN rail mounted miniature circuit breakers up to 63 amp current rating
- Single-pole, two-pole and three-pole models
- Suitable for reverse feed applications
- Suitable for branch circuit device protection
- Thermal-magnetic overcurrent protection – three levels of short circuit protection, categorized by B, C and D curves
- B-curve magnetic trip point: 3 to 5 times the rated current, typically used for resistive loads such as conductors or heaters.
- C-curve magnetic trip point: 5 to 10 times the rated current, typically used for small transformers, pilot devices, etc.
- D-curve magnetic trip point: 10 to 20 times the rated current, typically used for transformers or very high inductive loads.
- Trip-free design – breaker cannot be defeated by holding the handle in the “ON” position
- Captive screws cannot be lost
- Can also be used in applications for which UL 1077 or CSA C22.2 No.235 are also allowed
- Field installable shunt trip and auxiliary switches, side mountable
- Module width of only 18mm [0.71 in] (per pole)
- Contact position indicator (red / green)
- 35mm DIN rail mountable, utilizing spring clip

Full Line of Field Installable Accessories

- Auxiliary switch
- Alarm/auxiliary switch
- Shunt trip
- Padlock provision

Applications

- Feeder and Branch Circuit Protection
- PLC I/O points
- Motor control circuits
- Control instrumentation
- Power supplies
- Relays
- Convenience receptacle circuits (internal / external)
- Load circuits leaving the equipment (external)
- Computers
- UPS
- HACR Equipment (Heating Air Conditioning, Refrigeration)
- Power conditioners





Miniature Circuit Breakers

Tripping Characteristics

Gladiator miniature circuit breakers are available with "B" or "C" or "D" tripping characteristics.

Type B trip curve

(3 to 5 times I_n)

B-curve devices are suitable for resistive loads such as conductors or heaters.

Type C trip curve

(5 to 10 times I_n)

C-curve devices are suitable for applications where medium levels of inrush current are expected. Applications include small transformers, lighting, pilot devices, control circuits and coils. C-curve devices provide a medium magnetic trip point.

Type D trip curve

(10 to 20 times I_n)

D-curve devices are suitable for applications where high levels of inrush current are expected. The high magnetic trip point prevents nuisance tripping in high inductive applications such as motors, transformers and power supplies.

Labeling

The front of each Gladiator miniature circuit breaker is labeled for positive identification.

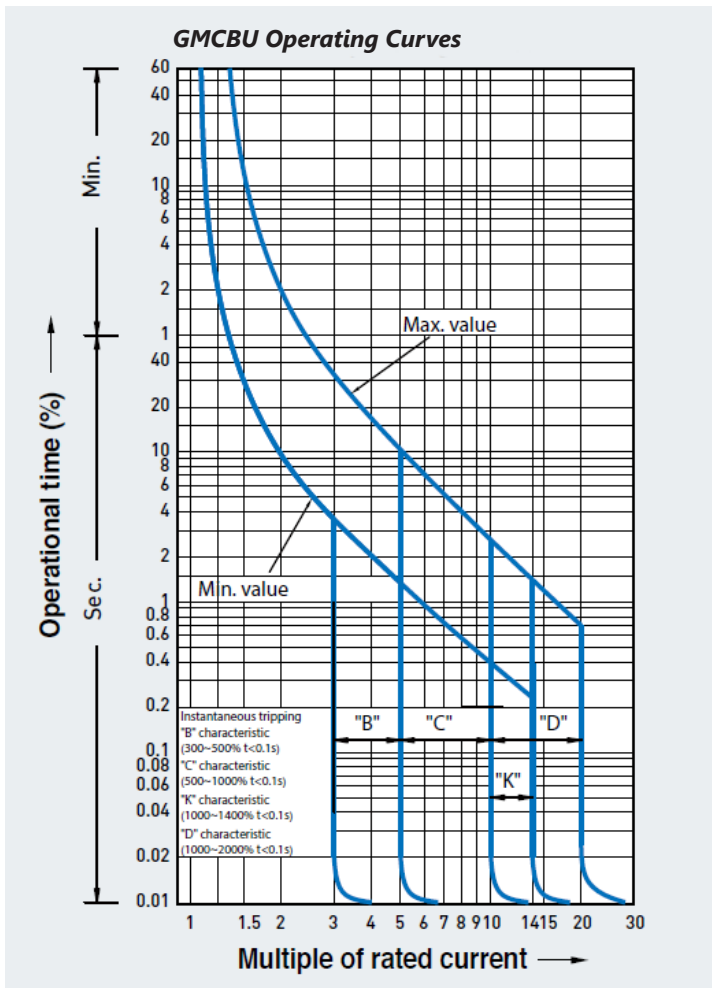
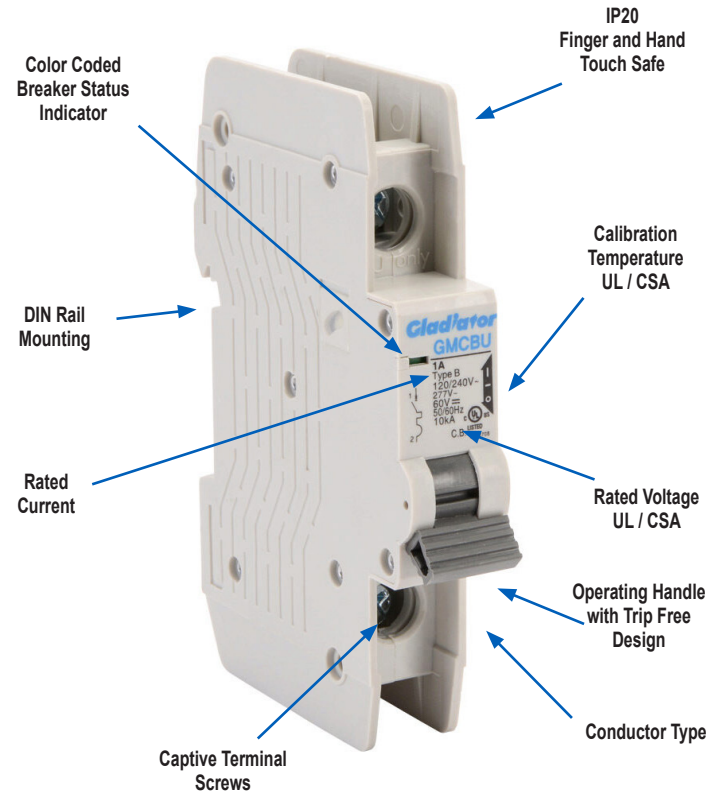



Miniature Circuit Breakers (UL 489)



Single-Pole

Gladiator UL 489 Single-Pole 277 VAC Selection Guide						
Ampere Rating	B-Curve Part Number	Price	C-Curve Part Number	Price	D-Curve Part Number	Price
1	GMCBU-1B-1	\$17.00	GMCBU-1C-1	\$17.00	GMCBU-1D-1	\$17.00
2	GMCBU-1B-2	\$17.00	GMCBU-1C-2	\$17.00	GMCBU-1D-2	\$17.00
3	GMCBU-1B-3	\$17.00	GMCBU-1C-3	\$17.00	GMCBU-1D-3	\$17.00
4	GMCBU-1B-4	\$17.00	GMCBU-1C-4	\$17.00	GMCBU-1D-4	\$17.00
5	GMCBU-1B-5	\$17.00	GMCBU-1C-5	\$17.00	GMCBU-1D-5	\$17.00
6	GMCBU-1B-6	\$17.00	GMCBU-1C-6	\$17.00	GMCBU-1D-6	\$17.00
8	GMCBU-1B-8	\$17.00	GMCBU-1C-8	\$17.00	GMCBU-1D-8	\$17.00
10	GMCBU-1B-10	\$17.00	GMCBU-1C-10	\$17.00	GMCBU-1D-10	\$17.00
15	GMCBU-1B-15	\$17.00	GMCBU-1C-15	\$17.00	GMCBU-1D-15	\$17.00
16	GMCBU-1B-16	\$17.00	GMCBU-1C-16	\$17.00	GMCBU-1D-16	\$17.00
20	GMCBU-1B-20	\$17.00	GMCBU-1C-20	\$17.00	GMCBU-1D-20	\$17.00
25	GMCBU-1B-25	\$17.00	GMCBU-1C-25	\$17.00	GMCBU-1D-25	\$17.00

Gladiator UL 489 Single-Pole 120/240 VAC Selection Guide						
30	GMCBU-1B-30	\$17.00	GMCBU-1C-30	\$17.00	GMCBU-1D-30	\$17.00
32	GMCBU-1B-32	\$17.00	GMCBU-1C-32	\$17.00	GMCBU-1D-32	\$17.00
40	GMCBU-1B-40	\$17.00	GMCBU-1C-40	\$17.00	GMCBU-1D-40	\$17.00
50	GMCBU-1B-50	\$19.00	GMCBU-1C-50	\$19.00	GMCBU-1D-50	\$19.00
63	GMCBU-1B-63	\$19.00	GMCBU-1C-63	\$19.00	GMCBU-1D-63	\$19.00



Two-Pole

Gladiator UL 489 Two-Pole 480Y/277 VAC Selection Guide						
Ampere Rating	B-Curve Part Number	Price	C-Curve Part Number	Price	D-Curve Part Number	Price
1	GMCBU-2B-1	\$32.50	GMCBU-2C-1	\$32.50	GMCBU-2D-1	\$32.50
2	GMCBU-2B-2	\$32.50	GMCBU-2C-2	\$32.50	GMCBU-2D-2	\$32.50
3	GMCBU-2B-3	\$32.50	GMCBU-2C-3	\$32.50	GMCBU-2D-3	\$32.50
4	GMCBU-2B-4	\$32.50	GMCBU-2C-4	\$32.50	GMCBU-2D-4	\$32.50
5	GMCBU-2B-5	\$32.50	GMCBU-2C-5	\$32.50	GMCBU-2D-5	\$32.50
6	GMCBU-2B-6	\$32.50	GMCBU-2C-6	\$32.50	GMCBU-2D-6	\$32.50
8	GMCBU-2B-8	\$32.50	GMCBU-2C-8	\$32.50	GMCBU-2D-8	\$32.50
10	GMCBU-2B-10	\$32.50	GMCBU-2C-10	\$32.50	GMCBU-2D-10	\$32.50
15	GMCBU-2B-15	\$32.50	GMCBU-2C-15	\$32.50	GMCBU-2D-15	\$32.50
16	GMCBU-2B-16	\$32.50	GMCBU-2C-16	\$32.50	GMCBU-2D-16	\$32.50
20	GMCBU-2B-20	\$32.50	GMCBU-2C-20	\$32.50	GMCBU-2D-20	\$32.50
25	GMCBU-2B-25	\$32.50	GMCBU-2C-25	\$32.50	GMCBU-2D-25	\$32.50

Gladiator UL 489 Two-Pole 240VAC Selection Guide						
30	GMCBU-2B-30	\$32.50	GMCBU-2C-30	\$32.50	GMCBU-2D-30	\$32.50
32	GMCBU-2B-32	\$32.50	GMCBU-2C-32	\$32.50	GMCBU-2D-32	\$32.50
40	GMCBU-2B-40	\$32.50	GMCBU-2C-40	\$32.50	GMCBU-2D-40	\$32.50
50	GMCBU-2B-50	\$38.00	GMCBU-2C-50	\$38.00	GMCBU-2D-50	\$38.00
63	GMCBU-2B-63	\$38.00	GMCBU-2C-63	\$38.00	GMCBU-2D-63	\$38.00



Miniature Circuit Breakers (UL 489)



Three-Pole

Gladiator UL 489 Three-Pole 480Y/277 VAC Selection Guide						
Ampere Rating	B-Curve Part Number	Price	C-Curve Part Number	Price	D-Curve Part Number	Price
1	<u>GMCBU-3B-1</u>	\$49.00	<u>GMCBU-3C-1</u>	\$49.00	<u>GMCBU-3D-1</u>	\$49.00
2	<u>GMCBU-3B-2</u>	\$49.00	<u>GMCBU-3C-2</u>	\$49.00	<u>GMCBU-3D-2</u>	\$49.00
3	<u>GMCBU-3B-3</u>	\$49.00	<u>GMCBU-3C-3</u>	\$49.00	<u>GMCBU-3D-3</u>	\$49.00
4	<u>GMCBU-3B-4</u>	\$49.00	<u>GMCBU-3C-4</u>	\$49.00	<u>GMCBU-3D-4</u>	\$49.00
5	<u>GMCBU-3B-5</u>	\$49.00	<u>GMCBU-3C-5</u>	\$49.00	<u>GMCBU-3D-5</u>	\$49.00
6	<u>GMCBU-3B-6</u>	\$49.00	<u>GMCBU-3C-6</u>	\$49.00	<u>GMCBU-3D-6</u>	\$49.00
8	<u>GMCBU-3B-8</u>	\$49.00	<u>GMCBU-3C-8</u>	\$49.00	<u>GMCBU-3D-8</u>	\$49.00
10	<u>GMCBU-3B-10</u>	\$49.00	<u>GMCBU-3C-10</u>	\$49.00	<u>GMCBU-3D-10</u>	\$49.00
15	<u>GMCBU-3B-15</u>	\$49.00	<u>GMCBU-3C-15</u>	\$49.00	<u>GMCBU-3D-15</u>	\$49.00
16	<u>GMCBU-3B-16</u>	\$49.00	<u>GMCBU-3C-16</u>	\$49.00	<u>GMCBU-3D-16</u>	\$49.00
20	<u>GMCBU-3B-20</u>	\$49.00	<u>GMCBU-3C-20</u>	\$49.00	<u>GMCBU-3D-20</u>	\$49.00
25	<u>GMCBU-3B-25</u>	\$49.00	<u>GMCBU-3C-25</u>	\$49.00	<u>GMCBU-3D-25</u>	\$49.00
Gladiator UL 489 Three-Pole 240VAC Selection Guide						
30	<u>GMCBU-3B-30</u>	\$49.00	<u>GMCBU-3C-30</u>	\$49.00	<u>GMCBU-3D-30</u>	\$49.00
32	<u>GMCBU-3B-32</u>	\$49.00	<u>GMCBU-3C-32</u>	\$49.00	<u>GMCBU-3D-32</u>	\$49.00
40	<u>GMCBU-3B-40</u>	\$49.00	<u>GMCBU-3C-40</u>	\$49.00	<u>GMCBU-3D-40</u>	\$49.00
50	<u>GMCBU-3B-50</u>	\$57.00	<u>GMCBU-3C-50</u>	\$57.00	<u>GMCBU-3D-50</u>	\$57.00
63	<u>GMCBU-3B-63</u>	\$57.00	<u>GMCBU-3C-63</u>	\$57.00	<u>GMCBU-3D-63</u>	\$57.00



Miniature Circuit Breakers (UL 489)

Technical Specifications

Gladiator Miniature Circuit Breakers – UL 489				
		B-Curve	C-Curve	D-Curve
Short Circuit Trip Response		3-5 x In	5-10 x In	10-20 x In
Current Rating		1, 2, 3, 4, 5, 6, 8, 10, 15, 16, 20, 25, 30, 32, 40, 50, 63A		
Maximum Voltage Ratings UL / CSA	1-63 A, AC	1P: 120/240V 2P: 240V 3P: 240V		
	1-25 A, AC	1P: 277V 2P: 480Y/277V 3P: 480Y/277V		
	1-63 A, DC	1P: 60V 2P: 125V 3P: 125V		
Thermal Tripping Characteristics (Temperature)	Single-pole	104°F [40°C]		
	Multi-pole			
Interrupting Ratings (@ maximum voltage)	1-pole	AC: 10kA @ 120/240VAC, 10kA @ 277VAC (1~25A), 10kA @ 120/240VAC (30~63A) DC: 10kA @ 60VDC		
	2-pole	AC: 10kA @ 240VAC, 480Y/277 VAC(1~25A), 10kA@240VAC (30~63A) DC: 10kA @ 125VDC		
	3-pole			
Rated Frequency		50/60 Hz		
Agency Approvals		UL, CB		

Notes: Line voltage connection suitable for reverse feed

To obtain the most current agency approval information, see the Agency Approval Checklist section on the specific part number's web page.

Gladiator Miniature Circuit Breaker - IEC				
		B-Curve	C-Curve	D-Curve
Short Circuit Trip Response		3-5 x In	5-10 x In	10-20 x In
Current Rating		1, 2, 3, 4, 5, 6, 8, 10, 15, 16, 20, 25, 30, 32, 40, 50, 63A		
Maximum Voltage Ratings - IEC/EN 60947-2	1-pole	500VAC		
	2-pole / 3-pole			
	2 poles in series			
Thermal Tripping Characteristics (Temperature)	Single-pole	104°F [40°C]		
	Multi-pole			
Interrupt Ratings (At Max Voltage) Uimp		6kV		
Rated Frequency		50/60 Hz		

General Specifications		
Lifespan / Endurance	6,000 operations electrical	
Operating Temperature	23°F to 104°F [-5°C to 40°C]	
Housing Material	Engineering plastic	
Mounting Position	On 35mm DIN rail (vertical)	
Weight	1-pole	0.28 lb [130g]
	2-pole	0.58 lb [260g]
	3-pole	0.86 lb [390g]
Wire Size		
Conductor Size Copper Only, 149°F [65°C]	Lug type 14-4 AWG	
Tightening Torque		
Tightening Torque	35 lb•in [3.9 N•m]	

Gladiator[®] Series Technical Data (UL 489)

from AutomationDirect

Temperature Derating (UL 489)

Temperature Derating for UL 489 Influence of Ambient Temperature T on Load Carrying Capacity (UL 489)												
Device Current Rating in Amps at 104°F [40°C]	I _n (A) at Higher Ambient Temperature											
	-40°F [-40°C]	-22°F [-30°C]	-4°F [-20°C]	14°F [-10°C]	32°F [0°C]	50°F [10°C]	68°F [20°C]	86°F [30°C]	104°F [40°C]	122°F [50°C]	140°F [60°C]	158°F [70°C]
1	1.5	1.4	1.3	1.3	1.2	1.2	1.1	1.1	1.0	0.9	0.8	0.8
2	3.0	2.8	2.7	2.6	2.4	2.3	2.2	2.1	2.0	1.8	1.7	1.5
3	4.4	4.2	4.0	3.8	3.6	3.5	3.3	3.2	3.0	2.8	2.5	2.3
4	5.9	5.6	5.4	5.1	4.9	4.6	4.4	4.2	4.0	3.7	3.4	3.1
5	7.4	7.0	6.7	6.4	6.1	5.8	5.5	5.3	5.0	4.6	4.2	3.9
6	8.9	8.4	8.0	7.7	7.3	6.9	6.6	6.3	6.0	5.5	5.0	4.6
8	11.8	11.3	10.7	10.2	9.7	9.3	8.8	8.4	8.0	7.3	6.7	6.2
10	14.8	14.1	13.4	12.8	12.2	11.6	11.0	10.5	10.0	9.2	8.4	7.7
15	22.2	21.1	20.1	19.1	18.2	17.4	16.5	15.8	15.0	13.8	12.6	11.6
16	23.6	22.5	21.4	20.4	19.4	18.5	17.6	16.8	16.0	14.7	13.5	12.3
20	29.5	28.1	26.8	25.5	24.3	23.2	22.1	21.0	20.0	18.3	16.8	15.4
25	36.9	35.2	33.5	31.9	30.4	28.9	27.6	26.3	25.0	22.9	21.0	19.3
30	44.3	42.2	40.2	38.3	36.5	34.7	33.1	31.5	30.0	27.5	25.2	23.1
32	47.3	45.0	42.9	40.8	38.9	37.0	35.3	33.6	32.0	29.3	26.9	24.7
40	59.1	56.3	53.6	51.1	48.6	46.3	44.1	42.0	40.0	36.7	33.6	30.8
50	73.9	70.4	67.0	63.8	60.8	57.9	55.1	52.5	50.0	45.9	42.0	38.6
63	93.1	88.6	84.4	80.4	76.6	72.9	69.5	66.2	63.0	57.8	53.0	48.6

Power Loss at I_n (UL 489)

Power Loss at I _n			
Characteristic B			
I _n [A]	1p P[W]	2p P[W]	3p P[W]
1	1.2	1.5	3.2
2	1.4	3.2	3.5
3	1.2	2.9	3.9
4	1.3	3.1	4.3
5	1.6	3.2	3.5
6	1.3	2.6	3.9
8	1.5	3.1	4.3
10	1.6	3.7	5.3
15	1.9	4.4	5.2
16	1.9	4.3	6.1
20	2.5	5.3	8.6
25	3.2	6.1	9.3
30	3.6	6.5	9.6
32	3.5	7.0	10.5
40	4.2	8.2	12.4
50	5.5	10.2	15.5
63	6.3	12.6	19.1

Power Loss at I _n			
Characteristic C			
I _n [A]	1p P[W]	2p P[W]	3p P[W]
1	1.1	1.8	3.2
2	1.3	2.2	4.2
3	1.1	2.1	3.7
4	1.2	2.8	4.0
5	1.5	3.0	3.7
6	1.2	2.3	3.5
8	1.4	3.1	4.2
10	1.5	2.8	4.3
15	1.8	3.3	4.8
16	1.8	3.6	5.4
20	2.7	4.8	8.2
25	3.1	5.9	9.1
30	3.3	6.4	9.5
32	3.7	7.1	10.7
40	4.0	7.9	12.3
50	4.8	9.7	15.1
63	6.1	12.1	18.5

Power Loss at I _n			
Characteristic D			
I _n [A]	1p P[W]	2p P[W]	3p P[W]
1	1.5	2.1	2.8
2	1.2	2.3	3.3
3	1.3	2.4	3.9
4	1.1	2.3	3.8
5	1.4	2.5	3.8
6	1.4	2.4	3.7
8	1.9	2.9	3.2
10	1.5	2.7	4.2
15	1.6	2.9	4.3
16	1.7	3.1	4.5
20	2.0	3.3	4.9
25	2.7	5.4	7.3
30	3.0	5.9	8.8
32	3.3	5.9	9.8
40	3.7	7.2	10.7
50	4.8	9.2	14.1
63	6.0	11.6	17.9



Miniature Circuit Breakers Accessories (UL 489)

Gladiator Miniature Circuit Breakers Accessories										
Part Number	Price	Description	For Use With	Rating	Control Voltage (U _c)	Operation Voltage	Trip Voltage	VA/Watt	Operating Time	Dimensions in [mm]
<u>GMCBU-AUX11</u>	\$14.50	Auxiliary contact	UL 489 models	6A @ 240VAC 3A @ 415VAC 1A @ 110VDC 2A @ 48VDC	-	-	-	-	-	0.35x4.13x2.60 [9x105x66]
<u>GMCBU-ALM11</u>	\$17.00	Alarm contact	UL 489 models							
<u>GMCBU-SH110-380VAC</u>	\$23.50	Shunt trip	UL 489 models	-	110-380 VAC 60-220 VDC	80-110% U _e	-	70	300ms	0.71x4.13x2.60 [18x105x66]
<u>GMCBU-UV110-120VAC</u>	\$29.50	Undervoltage trip	UL 489 models	-	110-120 VAC 220-240 VAC	-	35-70% U _e	1	2s	0.71x4.13x2.60 [18x105x66]
<u>GMCBU-UV220-240VAC</u>	\$29.50	Undervoltage trip	UL 489 models	-				3.5	2s	



[GMCBU-AUX11](#)



[GMCBU-ALM11](#)



[GMCBU-SH110-380VAC](#)



[GMCBU-UV110-120VAC](#)
[GMCBU-UV220-240VAC](#)

Gladiator Miniature Circuit Breakers Locking Device						
Part Number	Price	Description	For use with	Lock opening diameter	Weight	To operate
<u>GMCBU-LOCK</u>	\$6.75	Locking device	UL 489 and UL 1077 models	0.28 in [7.0]	Not less than 4.23 oz [120g]	Press button and insert into the handle

Note: Do not overpull by 10kg F.

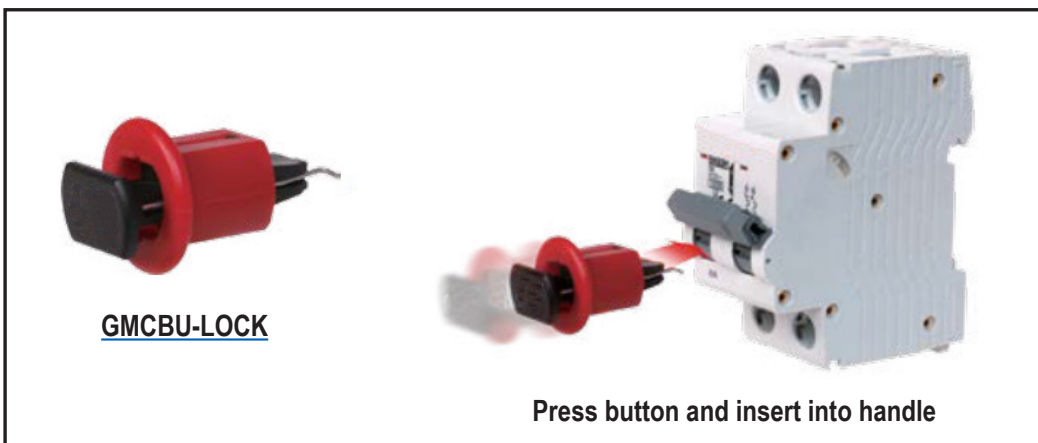

[GMCBU-LOCK](#)









Miniature Circuit Breakers Accessories (UL 489)

Contact Diagrams

GMCBU-AUX11

	OFF	TRIP	ON
MCB 			
AUX 			

GMCBU-ALM11

	OFF	TRIP	ON
MCB 			
ALM 			

Connecting Accessories

Auxiliary contacts

Up to 0.71 in
[18mm]

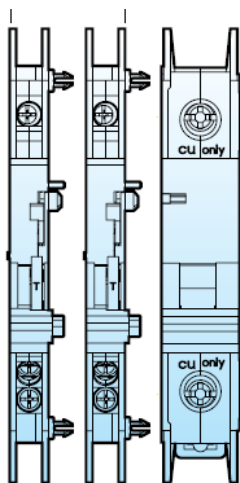

Tripping devices

Up to 1.42 in
[36mm]

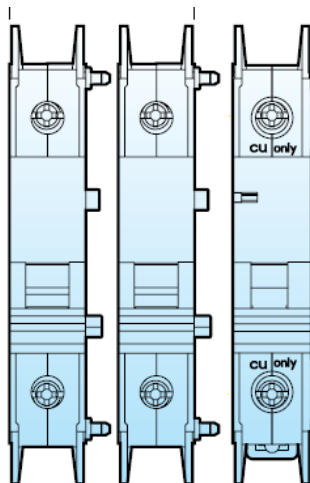

Both auxiliary contacts and tripping devices

Up to 2.13 in
[54mm]

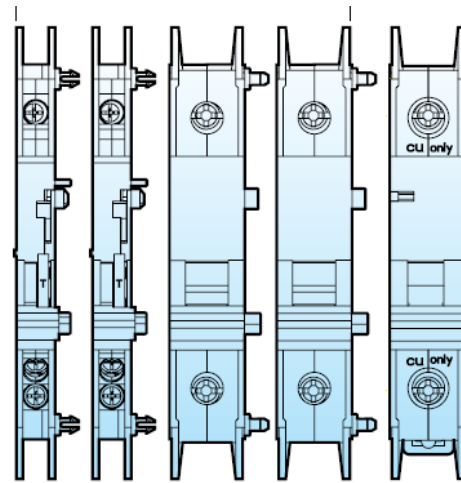

Gladiator Cuttable Busbars

Gladiator

from AutomationDirect

Gladiator busbars are the first cuttable UL489 rail and are available in a wide range of step spacings and cross-sections.

Whether you're feeding from the top, the bottom, centrally, or laterally, the Gladiator busbar system provides the flexibility you need to meet all requirements and any mounting situation.

Accessories such as feeder terminals and contact-protective, finger-safe end caps are also available.

These busbars are suitable for DC applications and for use in situations with a high degree of pollution.

Features

- For AC or DC applications
- One of the first cuttable UL489 busbars – no special tools required
- For GFCB/GFCBU series MCBs and protectors
- Can be used with fuse holders according to UL 512
- Can be used with 1-, 2-, or 3-phase systems
- Rated for 80/100 A
- Center feeding at 160/200 A
- Available accessories include feeder terminals, finger-safe push-on terminal covers, and end caps
- Completely closed
- Protection class: IP 20
- 2014/35/EU (Low Voltage Directive)
- 2011/65/EU Annex II 2015/863/EU



UL file number E197592



GMCB-BB3P-57-100C



GMCB-BB1P-57-100C

UL508 Gladiator Busbars Selection Guide

Part Number	Price	Amps	Voltage (VAC/VDC)	Number of Pins	Cut to Length?	Connections	Endcaps	Drawing
GMCB-BB1P-57-100C	\$34.00	100	600	57	Yes	Up to 57 1-pole Gladiator GFCB series miniature circuit breakers without auxiliary components	2, included	PDF
GMCB-BB2P-56-100C	\$51.00	100	600	56	Yes	Up to 28 2-pole Gladiator GFCB series miniature circuit breakers without auxiliary components	2, included	PDF
GMCB-BB3P-57-100C	\$72.00	100	600	57	Yes	Up to 19 3-pole Gladiator GFCB series miniature circuit breakers without auxiliary components	2, included	PDF

UL508 Gladiator Busbars Technical Specifications

Voltage Ratings	Single Phase	2 and 3 phase
Max AC Voltage	600VAC	
Max DC Voltage	1000VDC	600VDC
Current Ratings	End Feed	Center Feed
Max Current, 25mm ² Cross Section	100A	200A*
Protection Class	IP20	IP20
KA Rating (J Fuse)	100KA	
25mm ² (3 Fuse)	200A	

* Two 115A feeder terminals required per phase.

UL489 Gladiator Busbars Selection Guide

Part Number	Price	Amps	Voltage (VAC/VDC)	Number of Pins	Cut to Length?	Connections	Endcaps	Drawing
GMCBU-BB1P-12-100C	\$20.50	100	1000	12	Yes	Up to 12 1-pole Gladiator GMCBU series miniature circuit breakers without auxiliary components	2, included	PDF
GMCBU-BB1P-57-100C	\$79.00	100	1000	57	Yes	Up to 57 1-pole Gladiator GMCBU series miniature circuit breakers without auxiliary components	2, included	PDF
GMCBU-BB2P-12-100C	\$25.00	100	1000	12	Yes	Up to 6 2-pole Gladiator GMCBU series miniature circuit breakers without auxiliary components	2, included	PDF
GMCBU-BB2P-56-100C	\$98.00	100	1000	56	Yes	Up to 28 2-pole Gladiator GMCBU series miniature circuit breakers without auxiliary components	2, included	PDF
GMCBU-BB3P-12-100C	\$28.50	100	1000	12	Yes	Up to 4 3-pole Gladiator GMCBU series miniature circuit breakers without auxiliary components	2, included	PDF
GMCBU-BB3P-57-100C	\$112.00	100	1000	57	Yes	Up to 19 3-pole Gladiator GMCBU series miniature circuit breakers without auxiliary components	2, included	PDF

UL489 Gladiator Busbars Technical Specifications

Voltage Ratings	Single Phase	2 and 3 phase
Max AC Voltage	1000VAC	600VAC
Max DC Voltage	1000VDC	600VDC
Current Ratings	End Feed	Center Feed
Max Current, 25mm ² Cross Section	100A	200A*
Protection Class	IP20	IP20
KA Rating (J Fuse)	140KA	
25mm ² (3 Fuse)	200A	

* Two 115A feeder terminals required per phase.

Gladiator Cuttable Busbars Accessories



UL508 Gladiator Busbars Accessories Selection Guide

Part Number	Price	Description	For Use With	Drawing
<u>GMCB-BB1P-ECAP</u>	\$5.50	Gladiator end cap. Package of 10.	For use with Gladiator GMCB series 1-phase busbars.	<u>PDF</u>
<u>GMCB-BBM-ECAP</u>	\$6.50	Gladiator end cap. For use with Gladiator GMCB series 2-phase and 3-phase busbars. Package of 10.	For use with Gladiator GMCB series 2-phase and 3-phase busbars.	<u>PDF</u>
<u>GMCB-BBM-PTB</u>	\$49.00	Gladiator box type wiring lug, 115A, 1000 VAC/VDC, one opening, 1/0 to 10 AWG copper only. Package of 10.	For use with Gladiator GMCB series 2-phase and 3-phase UL1077 busbars.	<u>PDF</u>
<u>GMCB-BB1P-PTB</u>	\$43.50	Gladiator box type wiring lug, 115A, 1000 VAC/VDC, one opening, 1/0 to 10 AWG copper only. Package of 10.	For use with Gladiator GMCB series 1-phase UL1077 busbars.	<u>PDF</u>
<u>GMCB-BBM-BFT</u>	\$49.50	Gladiator direct feed wiring lug, 115A, 1000 VAC/VDC, one opening, 1 to 14 AWG copper only. Package of 10.	For use with Gladiator GMCB series UL1077 busbars.	<u>PDF</u>
<u>GMCB-BBM-TMC-5</u>	\$21.00	Gladiator safety cover. Package of 10. For use with up to five unused pins on Gladiator GMCB series busbars.	For use with up to five unused pins on Gladiator GMCB series busbars.	<u>PDF</u>

UL489 Gladiator Busbars Accessories Selection Guide

Part Number	Price	Description	For Use With	Drawing
<u>GMCBU-BBM-BFT</u>	\$48.00	Gladiator direct feed wiring lug, 115A, 1000 VAC/VDC, one opening, 1 to 14 AWG copper only. Package of 8.	For use with Gladiator GMCBU series UL489 busbars.	<u>PDF</u>
<u>GMCBU-BBM-ECAP</u>	\$8.25	Gladiator end cap. Package of 10.	For use with Gladiator GMCBU series busbars.	<u>PDF</u>
<u>GMCBU-BBM-PTB</u>	\$70.00	Gladiator box type wiring lug, 115A, 1000 VAC/VDC, one opening, 2 to 14 AWG copper only. Package of 10.	For use with Gladiator GMCBU series UL489 busbars.	<u>PDF</u>
<u>GMCBU-BBM-TMC-3</u>	\$12.00	Gladiator safety cover. Package of 10.	For use with up to three unused pins on Gladiator GMCBU series busbars.	<u>PDF</u>

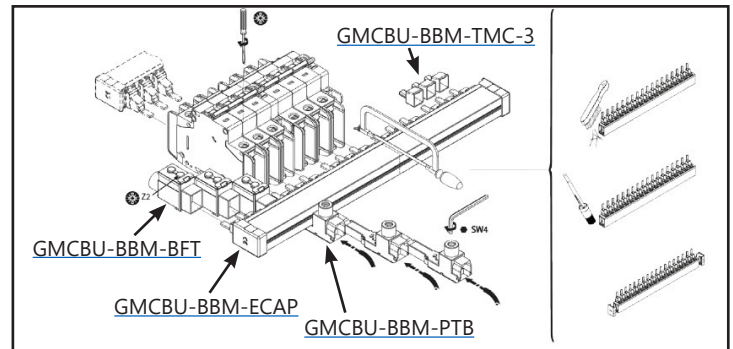
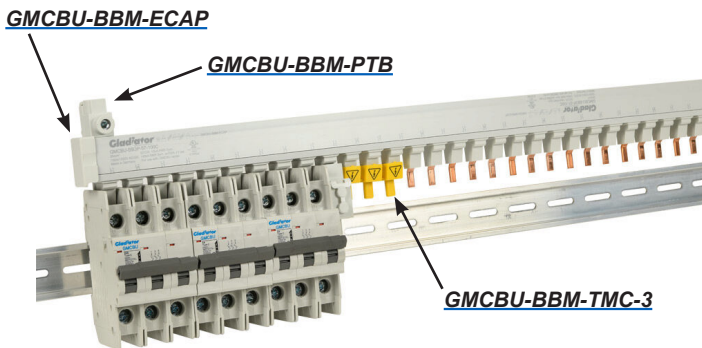

Complete system of cuttable busbar with accessories for top and bottom feeding.

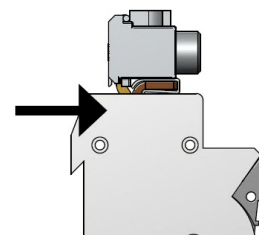
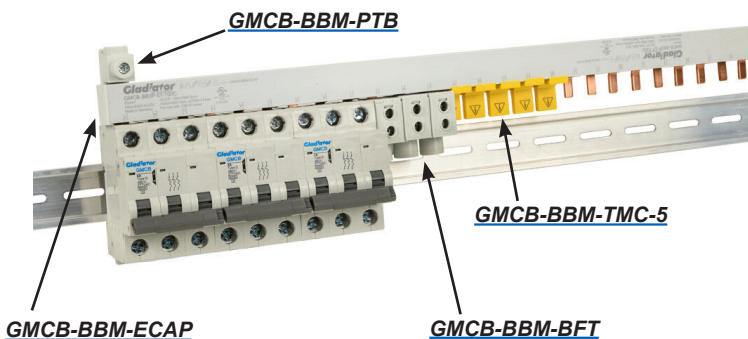

1-Phase Feeder Terminal

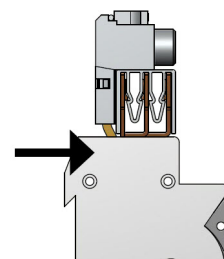

2- and 3-Phase Feeder Terminal