

GH15 Series IEC Motor Controls

The GH15 series of IEC contactors and thermal overload relays are manufactured by Europe's leading maritime contactor company. Contactors for ocean-going vessels are built to the most rigid specifications. This same design technology carries over to this line of industrial motor controls.

We offer individual components that

allow you to use the contactor alone or to assemble your motor starter using our thermal overload relays. You can also combine a manual motor starter/protector for all-in-one protection.

Use contactors wherever you need a heavy-duty switching device with up to three poles. Add up to 2 side-mounted auxiliary blocks (1 per side)

plus 1 top-mounted auxiliary contact block per contactor max. This will equal up to 8 possible auxiliary contact configurations. Or use the optional mechanical interlock to create an inexpensive reversing contactor.

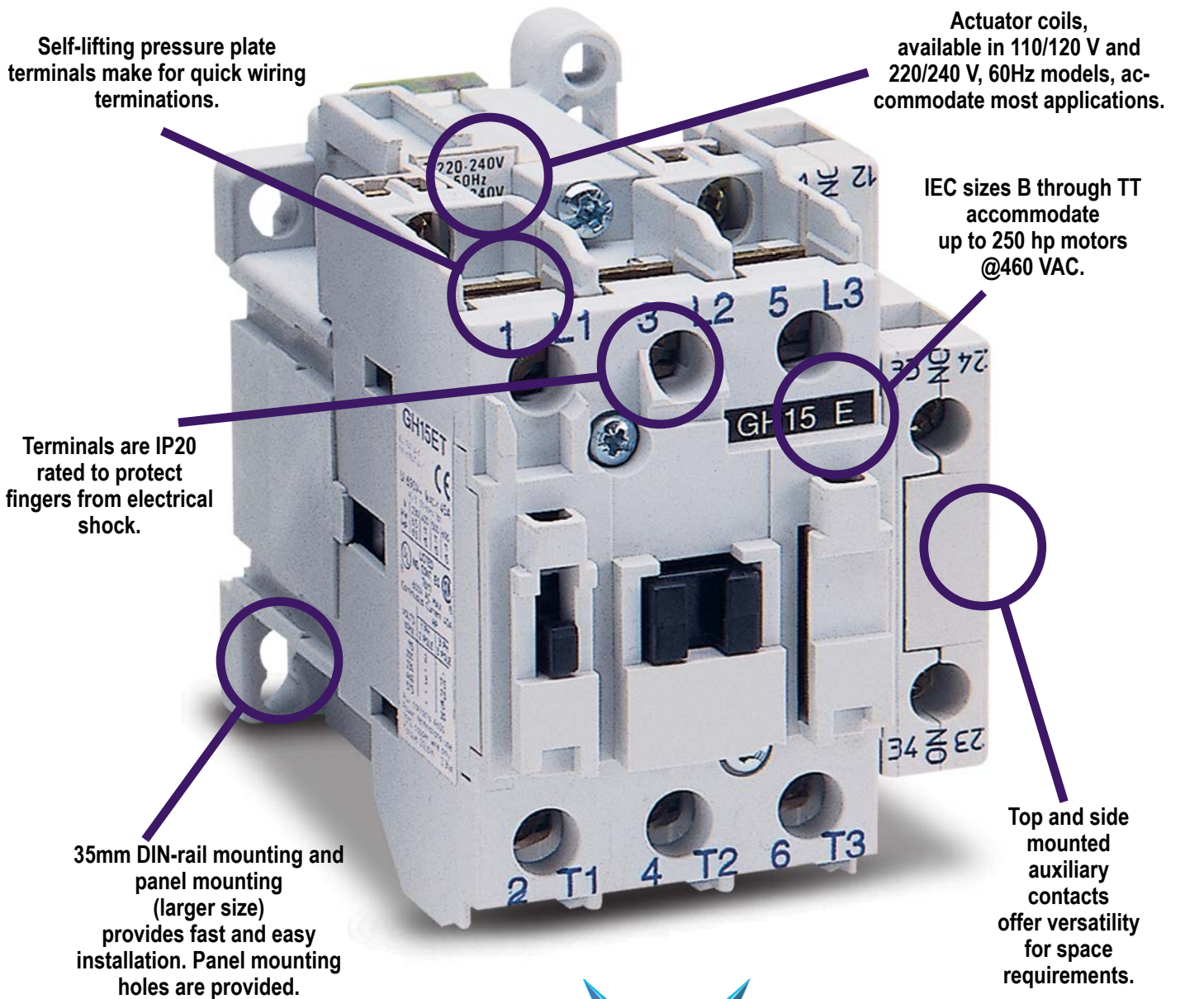

Self-lifting pressure plate terminals make for quick wiring terminations.

Actuator coils, available in 110/120 V and 220/240 V, 60Hz models, accommodate most applications.

IEC sizes B through TT accommodate up to 250 hp motors @460 VAC.

Terminals are IP20 rated to protect fingers from electrical shock.

35mm DIN-rail mounting and panel mounting (larger size) provides fast and easy installation. Panel mounting holes are provided.

Top and side mounted auxiliary contacts offer versatility for space requirements.

Approvals

- cULus listed #E191059
- UL 60947-4-1A



See next page for detailed specifications.

GH15 Series Contactor Configurations

Contactor Configurations								
IEC FRAME SIZE	Contactor Model*	Part Number	Price	Number of Contacts			Coil Voltage and Frequency	
				Main	Auxiliary Contacts Included			
					N.O	N.C.		
45 mm	GH15BN	GH15BN-3-10A	\$49.00	3	1	–	110-120 VAC 50-60 Hz	
		GH15BN-3-01A	\$48.00	3	–	1	110-120 VAC 50-60 Hz	
		GH15BN-3-10B	\$49.00	3	1	–	220-240 VAC 50-60 Hz	
	GH15CN	GH15CN-3-10A	\$56.00	3	1	–	110-120 VAC 50-60 Hz	
		GH15CN-3-01A	\$56.00	3	–	1	110-120 VAC 50-60 Hz	
		GH15CN-3-10B	\$56.00	3	1	–	220-240 VAC 50-60 Hz	
		GH15CN-3-01B	\$56.00	3	–	1	220-240 VAC 50-60 Hz	
	GH15DN	GH15DN-3-10A	\$61.00	3	1	–	110-120 VAC 50-60 Hz	
		GH15DN-3-01A	\$61.00	3	–	1	110-120 VAC 50-60 Hz	
		GH15DN-3-10B	\$61.00	3	1	–	220-240 VAC 50-60 Hz	
		GH15DN-3-01B	\$61.00	3	–	1	220-240 VAC 50-60 Hz	
	GH15ET	GH15ET-3-00A	\$92.00	3	–	–	110-120 VAC 50-60 Hz	
		GH15ET-3-00B	\$92.00	3	–	–	220-240 VAC 50-60 Hz	
	GH15FT	GH15FT-3-00A	\$100.00	3	–	–	110-120 VAC 50-60 Hz	
GH15FT-3-00B		\$100.00	3	–	–	220-240 VAC 50-60 Hz		
60 mm	GH15GT	GH15GT-3-00A	\$181.00	3	–	–	120 VAC 60 Hz only	
		GH15GT-3-00B	\$179.00	3	–	–	240 VAC 60 Hz / 212 VAC 50 Hz	
	GH15HT	GH15HT-3-00A	\$202.00	3	–	–	120 VAC 60 Hz only	
		GH15HT-3-00B	\$202.00	3	–	–	240 VAC 60 Hz / 212 VAC 50 Hz	
	GH15JT	GH15JT-3-00A	\$211.00	3	–	–	120 VAC 60 Hz only	
		GH15JT-3-00B	\$211.00	3	–	–	240 VAC 60 Hz / 212 VAC 50 Hz	
79 mm	GH15KT	GH15KT-3-00A	\$260.00	3	–	–	120 VAC 60 Hz only	
		GH15LT-3-00A	\$308.00	3	–	–	120 VAC 60 Hz only	
	GH15MT	GH15LT-3-00B	\$308.00	3	–	–	240 VAC 60 Hz / 212 VAC 50 Hz	
		GH15MT-3-00A	\$342.00	3	–	–	110-120 VAC 50-60 Hz / 110 VDC	
		GH15MT-3-00B	\$342.00	3	–	–	220-240 VAC 50-60 Hz	
110 mm	GH15NT	GH15NT-3-00A	\$453.00	3	–	–	110-120 VAC 50-60 Hz / 110 VDC	
		GH15PT	GH15PT-3-00A	\$548.00	3	–	–	110-120 VAC 50-60 Hz / 110 VDC
			GH15PT-3-00B	\$548.00	3	–	–	220-240 VAC 50-60 Hz / 220 VDC
145 mm	GH15RT	GH15RT-3-00A	\$683.00	3	–	–	110-120 VAC 50-60 Hz / 110 VDC	
		GH15ST	GH15ST-3-00A	\$728.00	3	–	–	110-120 VAC 50-60 Hz / 110 VDC
	GH15TT		GH15TT-3-00A	\$968.00	3	–	–	110-120 VAC 50-60 Hz / 110 VDC
		GH15TT-3-00B	\$968.00	3	–	–	220-240 VAC 50-60 Hz / 220 VDC	

* Up to 2 auxiliary contact blocks may be added to the contactor by utilizing the side mount and top mount contact block assemblies. Though referred to as a top mount assembly, the GH15T mounts to the front of the contactor.

Note: If using the [BM0H](#) or [BM3H-AD](#) mechanical interlock, the use of auxiliary contacts is prohibited on the side of each contactor where the interlock is mounted. This does not pertain to the auxiliary contact built into the GH15BN, GH15CN and GH15DN contactors.

GH15 Series 45mm Contactor Specifications

45mm Contactor Specifications								
Contactor Model			GH15BN	GH15CN	GH15DN	GH15ET	GH15FT	
Insulation Voltage	AC	(V)	600 Volts AC					
Ampere Rating UL 508	Max. UL Continuous Current	(A)	11	14	19	32	32	
	Max. UL General Use Current note 2	(A)	20	20	25	40	45	
Maximum Power (hp) of Three-Phase Motors	200V	(hp)	2	3	3	7.5	7.5	
	230/240V	(hp)	3	3	5	7.5	10	
	460/480V	(hp)	5	7.5	10	15	20	
	575V	(hp)	7.5	10	15	20	25	
Maximum Power (hp) of Single-Phase Motors	115V	(hp)	0.5	0.5	1	2	2	
	230/240V	(hp)	1	2	3	3	5	
Insulation Voltage	AC	(V)	690 Volts AC					
Ampere Rating EN/IEC 60947	AC-3 I _e (ambient Temp = 55°C @ 440V)	(A)	9	12	16	25	32	
	AC-1 I _e (ambient Temp = 40°C @ 690V)	(A)	30	30	30	45	50	
Maximum Power (kW) of Three-Phase Motors AC3 Category note 1	230/240V	(kW)	2.2	3	4	6.5	7.5	
	400V	(kW)	4	5.5	7.5	11	15	
	440/480V	(kW)	4.7	6.4	9	12.5	16.5	
	500V	(kW)	5.5	7.5	10	11	15	
	690V	(kW)	5.5	7.5	7.5	11	15	
Max Short Circuit Protection Fuses Class RK5 UL Rated Fuses	Type 2 Coordination note 3	(A)	25	30	50	60	70	
SCCR Rating (kA)		kA	5	5	5	5	5	
Auxiliary Contacts Electrical Capacity	A600 note 4							
Coil Voltage Operating Limits	AC Pick-up 85-110% rated control voltage / AC Drop-out 20-75% rated control voltage							
Average Coil Power Requirements / Coil current (A) = VA/Coil Voltage	AC Pick-Up (VA) 80-100 / AC Sealed (VA) 9-12							
Power Factor	Pick-up 0.65 / Sealed 0.35							
Coil Operating Time at Rated Coil Voltage	Pick-up (ms) 10-25 / Drop-out (ms) 6-18							
Maximum Operating Frequency (No-Load Operation)	3000 operations / hour							
Mechanical Durability	10,000,000 operations							
Operating Ambient Temperature	-25 to +70C (-13 to +158F)							
Electrical Protection Degree	IP20 (IP10 for power entry cables)							
Mounting	Screw (panel mount) or 35mm DIN rail							
Main Circuit Connections	Wire Size	14-10 AWG Stranded			14-8 AWG Stranded			
	Tightening Torque	1.4 N·m (12 lb-in)			2.3 N·m (20 lb-in)			
Auxilliary Circuit Connections	Wire Size	16-12 AWG Stranded / 14-12 AWG Solid						
	Tightening Torque	0.8 N·m (7 lb-in)						

Notes

- AC3 type loads consist of squirrel cage three phase motors.
- AC1 non-inductive or slightly inductive loads. Typically resistive loads (i.e. furnaces, ovens, etc.)
- Type 2 coordination is a protection category for IEC 60947-4-1. Section 8.2.5.1 specifies that Type 2 coordination requires that, under short circuit conditions, the contactor or starter shall cause no danger to persons or installations, and shall be suitable for further use. The risk of minor contact welding is possible.

Contactor Diagram

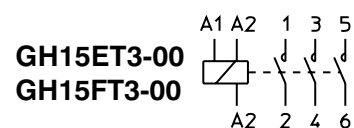
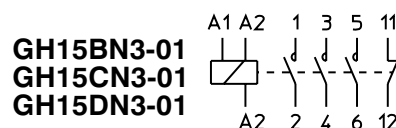
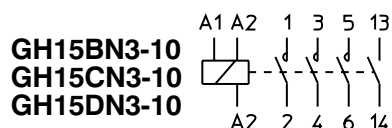

GH15 Series 60mm Contactor Specifications

60mm Contactor Specifications					
Contactor Model			GH15GT	GH15HT	GH15JT
Insulation Voltage	AC	(V)	600 Volts AC		
Ampere Rating UL 508	Max. UL Continuous Current	(A)	42	52	65
	Max. UL General Use Current note 2	(A)	60	70	80
Maximum Power (hp) of Three-Phase Motors	200V	(hp)	10	15	15
	230/240V	(hp)	10	15	20
	460/480V	(hp)	25	30	40
	575V	(hp)	30	40	50
Maximum Power (hp) of Single-Phase Motors	115V	(hp)	3	3	5
	230/240V	(hp)	5	7.5	10
Insulation Voltage	AC	(V)	690 Volts AC		
Ampere Rating EN/IEC 60947	AC-3 I _e (ambient Temp = 55°C @440V)	(A)	40	50	63
	AC-1 I _e (ambient Temp = 40°C @690V)	(A)	63	80	100
Maximum Power (kW) of Three-Phase Motors AC3 Category note 1	230/240V	(kW)	11	12.5	18.5
	400V	(kW)	18.5	22	30
	440/480V	(kW)	21	25	33
	500V	(kW)	18.5	22	30
	690V	(kW)	18.5	22	30
Max Short Circuit Protection Circuit Breaker UL Rated MCCB	Type 2 Coordination note 3	(A)	150	175	200
SCCR Rating (kA)		(kA)	5	5	5
Auxiliary Contacts Electrical Capacity			A600 note 4		
Coil Voltage Operating Limits			AC Pick-up 85-110% rated control voltage AC Drop-Out 20-75% rated control voltage		
Average Coil Power Requirements / Coil current (A) = VA/Coil Voltage			AC Pick-up (VA) 250 / AC Sealed (VA) 18		
Power Factor			Pick-up 0.54 / Sealed 0.35		
Coil Operating Time at Rated Coil Voltage			Pick-up (ms) 12-30 / Drop-out (ms) 6-15		
Maximum Operating Frequency (No-Load Operation)			3000 operations / hour		
Mechanical Durability			10,000,000 operations		
Operating Ambient Temperature			-25 to +70C (-13 to +158F)		
Electrical Protection Degree			IP20 (IP10 for power entry cables)		
Mounting			Screw (panel mount) or 35mm DIN rail		
Main Circuit Connections	Wire Size		12-3 AWG stranded		
	Tightening Torque		5.0 N·m (45 lb·in)		
Auxiliary Circuit Connections	Wire Size		16-12 AWG (stranded recommended)		
	Tightening Torque		0.8 N·m (7 lb·in)		

Notes

- AC3 type loads consist of squirrel cage three phase motors.
- AC1 non-inductive or slightly inductive loads. Typically resistive loads (i.e. furnaces, ovens, etc.)
- Type 2 coordination is a protection category for IEC 60947-4-1. Section 8.2.5.1 specifies that Type 2 coordination requires that, under short circuit conditions, the contactor or starter shall cause no danger to persons or installations, and shall be suitable for further use. The risk of minor contact welding is possible.
- NEMA ICS 5-2000. For more information, refer to Control Circuit Contact Electrical Ratings.

Contactor Diagram

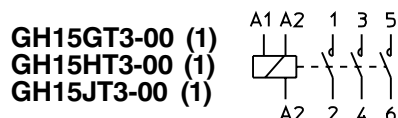

GH15 Series 79mm Contactor Specifications

79mm Contactor Specifications					
Contactor Model			GH15KT	GH15LT	GH15MT
Insulation Voltage	AC	(V)	600 Volts AC		
Ampere Rating UL 508	Max. UL Continuous Current	(A)	90	90	120
	Max. UL General Use Current note 2	(A)	90	100	120
Maximum Power (hp) of Three-Phase Motors	200V	(hp)	20	25	30
	230/240V	(hp)	25	30	40
	460/480V	(hp)	50	60	75
	575V	(hp)	60	75	100
Maximum Power (hp) of Single-Phase Motors	115V	(hp)	5	7.5	10
	230/240V	(hp)	15	15	20
Insulation Voltage	AC	(V)	1000 Volts AC		
Ampere Rating EN/IEC 60947	AC-3 I _e (ambient Temp = 55°C @440V)	(A)	80	95	110
	AC-1 I _e (ambient Temp = 40°C @690V)	(A)	125	125	135
Maximum Power (kW) of Three-Phase Motors AC3 Category note 1	230/240V	(kW)	22	25	30
	400V	(kW)	37	45	55
	440/480V	(kW)	45	51	63
	500V	(kW)	45	51	55
	690V	(kW)	45	51	55
Max Short Circuit Protection Fuses Class RK5 UL Rated Fuses	Type 2 Coordination note 3	(A)	250	250	225
SCCR Rating (kA)		(kA)	10	10	10
Auxiliary Contacts Electrical Capacity			A600 note 4		
Coil Voltage Operating Limits			AC/DC Pick-up 85-110% rated control voltage AC/DC Drop-Out 20-75% rated control voltage		
Average Coil Power Requirements / Coil current (A) = VA/Coil Voltage			AC Pick-up (VA) 250 / AC Sealed (VA) 18		AC Pick-up (VA) 250 AC Sealed 24-125V (VA) 4 AC Sealed 220-600V (VA) 19
Power Factor			Pick-up 0.54 / Sealed 0.35		Pick-up 0.98 Sealed 24-125V 0.98 Sealed 220-600V 0.2
Coil Operating Time at Rated Coil Voltage			Pick-up (ms) 12-30 / Drop-out (ms) 6-15		Pick-up (ms) 15-50 Drop-out (ms) 30-80
Maximum Operating Frequency (No-Load Operation)			3000 operations / hour		
Mechanical Durability			10,000,000 operations		
Operating Ambient Temperature			-25 to +70C (- 13 to +158F)		
Electrical Protection Degree			IP20 (Front)		
Mounting			Screw (panel mount)		
Main Circuit Connections	Wire Size		10-2 AWG Stranded (1 or 2 wires)		
	Tightening Torque		8.0 N·m (70 lb-in)		
Auxilliary Circuit Connections	Wire Size		2 x 16-12 AWG Stranded / 2 x 14-12 AWG Solid		
	Tightening Torque		0.8 N·m (7 lb-in)		

Notes

- AC3 type loads consist of squirrel cage three phase motors.
- AC1 non-inductive or slightly inductive loads. Typically resistive loads (i.e. furnaces, ovens, etc.)
- Type 2 coordination is a protection category for IEC 60947-4-1. Section 8.2.5.1 specifies that Type 2 coordination requires that, under short circuit conditions, the contactor or starter shall cause no danger to persons or installations, and shall be suitable for further use. The risk of minor contact welding is possible.
- NEMA ICS 5-2000. For more information, refer to Control Circuit Contact Electrical Ratings.

Contactor Diagram

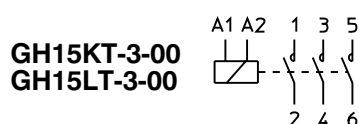

GH15 Series 110mm Contactor Specifications

110mm Contactor Specifications			GH15NT	GH15PT
Contactor Model				
Insulation Voltage	AC	(V)	600 Volts AC	
Ampere Rating UL 508	Max. UL Continuous Current	(A)	180	180
	Max. UL General Use Current note 2	(A)	180	220
Maximum Power (hp) of Three-Phase Motors	200V	(hp)	40	50
	230/240V	(hp)	50	60
	460/480V	(hp)	100	125
	575V	(hp)	125	150
Maximum Power (hp) of Single-Phase Motors	115V	(hp)	15	15
	230/240V	(hp)	25	30
Insulation Voltage	AC	(V)	1000 Volts AC	
Ampere Rating EN/IEC 60947	AC-3 I_e (ambient Temp = 55°C @440V)	(A)	150	175
	AC-1 I_e (ambient Temp = 40°C @690V)	(A)	230	250
Maximum Power (kW) of Three-Phase Motors AC3 Category note 1	230/240V	(kW)	40	50
	400V	(kW)	75	90
	440/480V	(kW)	85	100
	500V	(kW)	90	110
	690V	(kW)	110	132
Max Short Circuit Protection Fuses Class RK5 UL Rated Fuses	Type 2 Coordination note 3	(A)	300	350
SCCR Rating (kA)		(kA)	10	10
Auxiliary Contacts Electrical Capacity			A600 note 4	
Coil Voltage Operating Limits			AC/DC Pick-up 85-110% rated control voltage AC/DC Drop-Out 20-75% rated control voltage	
Average Coil Power Requirements / Coil current (A) = VA/Coil Voltage			AC Pick-up (VA) 350 / AC Sealed (VA) 5	
Power Factor			Pick-up 0.98 / Sealed 0.98	
Coil Operating Time at Rated Coil Voltage			Pick-up (ms) 30-60 / Drop-out (ms) 30-80	
Maximum Operating Frequency (No-Load Operation)			1200 operations / hour	
Mechanical Durability			10,000,000 operations	
Operating Ambient Temperature			-25 to +70C (- 13 to +158F)	
Electrical Protection Degree			IP00 - IP20	
Mounting			Screw (panel mount)	
Main Circuit Connections with Terminal Kit MR3-AD	Wire Size		2 x 4/0 AWG Stranded / 1 x 4/0 AWG Solid	
	Tightening Torque		17 N·m (150 lb·in)	
Auxilliary Circuit Connections	Wire Size		2 X 5-4/0 AWG Stranded	
	Tightening Torque		0.8 N·m (7 lb·in)	

Notes

- AC3 type loads consist of squirrel cage three phase motors.
- AC1 non-inductive or slightly inductive loads. Typically resistive loads (i.e. furnaces, ovens, etc.)
- Type 2 coordination is a protection category for IEC 60947-4-1. Section 8.2.5.1 specifies that Type 2 coordination requires that, under short circuit conditions, the contactor or starter shall cause no danger to persons or installations, and shall be suitable for further use. The risk of minor contact welding is possible.
- NEMA ICS 5-2000. For more information, refer to Control Circuit Contact Electrical Ratings.

Contactor Diagram

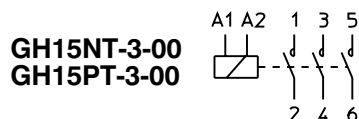

GH15 Series 145mm Contactor Specifications

145mm Contactor Specifications					
Contactor Model			GH15RT	GH15ST	GH15TT
Insulation Voltage	AC	(V)	600 Volts AC		
Ampere Rating UL 508	Max. UL Continuous Current	(A)	250	300	360
	Max. UL General Use Current note 2	(A)	250	300	360
Maximum Power (hp) of Three-Phase Motors	200V	(hp)	60	75	100
	230/240V	(hp)	75	100	125
	460/480V	(hp)	150	200	250
	575V	(hp)	200	250	300
Maximum Power (hp) of Single-Phase Motors	230/240V	(hp)	40	50	50
Insulation Voltage	AC	(V)	1000 Volts AC		
Ampere Rating EN/IEC 60947	AC-3 I_e (ambient Temp = 55°C @440V)	(A)	210	260	315
	AC-1 I_e (ambient Temp = 40°C @690V)	(A)	350	450	500
Maximum Power (kW) of Three-Phase Motors AC3 Category note 1	230/240V	(kW)	60	75	90
	400V	(kW)	110	132	160
	440/480V	(kW)	125	150	190
	500V	(kW)	132	160	210
	690V	(kW)	132	160	210
Max Short Circuit Protection Fuses Class RK5 UL Rated Fuses	Type 2 Coordination note 3	(A)	400	450	500
SCCR Rating (kA)		(kA)	18	18	18
Auxiliary Contacts Electrical Capacity			A600 note 4		
Coil Voltage Operating Limits			AC/DC Pick-up 85-110% rated control voltage AC/DC Drop-Out 20-75% rated control voltage		
Average Coil Power Requirements / Coil current (A) = VA/Coil Voltage			AC Pick-up (VA) 360 / AC Sealed (VA) 5		
Power Factor			Pick-up 0.98 / Sealed 0.98		
Coil Operating Time at Rated Coil Voltage			Pick-up (ms) 40-60 / Drop-out (ms) 40-60		
Maximum Operating Frequency (No-Load Operation)			1200 operations / hour		
Mechanical Durability			8,000,000 operations		
Operating Ambient Temperature			-25 to +70C (- 13 to +158F)		
Electrical Protection Degree			IP20 (Front)		
Mounting			Screw (panel mount)		
Main Circuit Connections with Terminal Kit KAL-4	Wire size		2 x 6-300 MCM (75° copper wire only)		
	Tightening Torque		31 N·m (275 lb·in)		
Auxiliary Circuit Connections	Wire Size		16-12 AWG Stranded / 14-12 AWG Solid		
	Tightening Torque		0.8 N·m (7 lb·in)		

Notes

- AC3 type loads consist of squirrel cage three phase motors.
- AC1 non-inductive or slightly inductive loads. Typically resistive loads (i.e. furnaces, ovens, etc.)
- Type 2 coordination is a protection category for IEC 60947-4-1. Section 8.2.5.1 specifies that Type 2 coordination requires that, under short circuit conditions, the contactor or starter shall cause no danger to persons or installations, and shall be suitable for further use. The risk of minor contact welding is possible.
- NEMA ICS 5-2000. For more information, refer to Control Circuit Contact Electrical Ratings.

Contactor Diagram

GH15RT-3-00
GH15ST-3-00
GH15TT-3-00

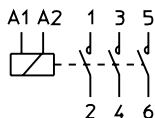

GH15 Series Contactor Electrical Durability of Main Contacts

Main contacts have a conductor material support, on which a silver alloy tip is welded. This tip makes, carries and breaks the load currents. The contact durability is represented by the average number of operations which the contact can carry out without maintenance and before the contact requires replacement. Every operation involves mechanical stresses

when the contactor closes and thermal stress during load current conduction. However, the main stress that affects contact durability is due to the electric arc between contacts during making and breaking operations. The electric arc causes the erosion of the contact active material; such erosion will increase according to the intensity of the current

and the arcing time. Therefore the contact durability is strictly dependent on the type of load, i.e. on the utilization category, rated operational current and rated voltage. The following diagrams give curves of contact durability for each contactor for use in category AC-1, AC-3 and AC-4.

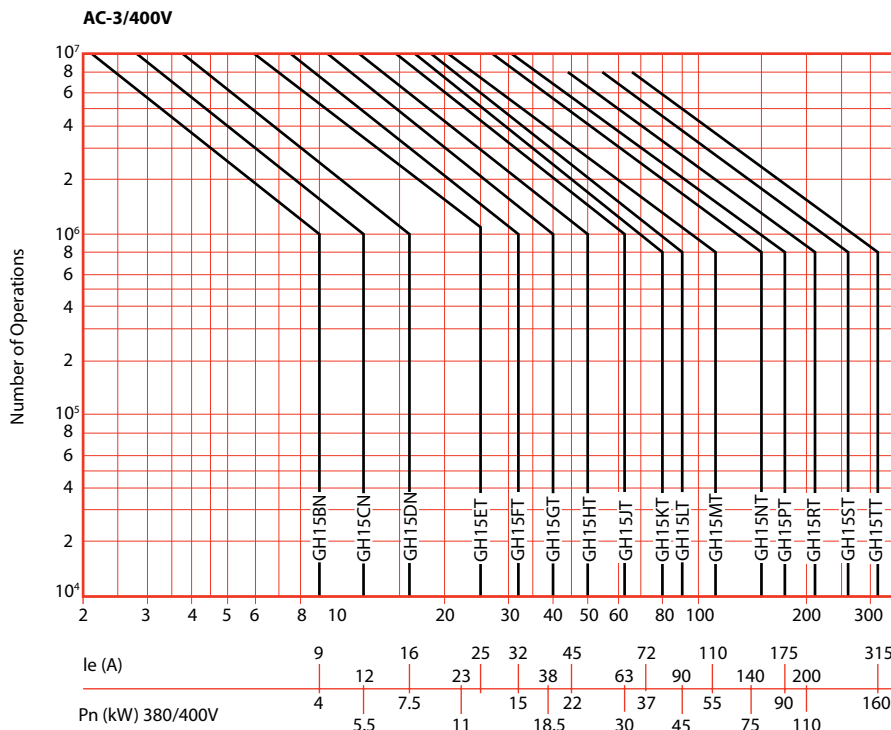
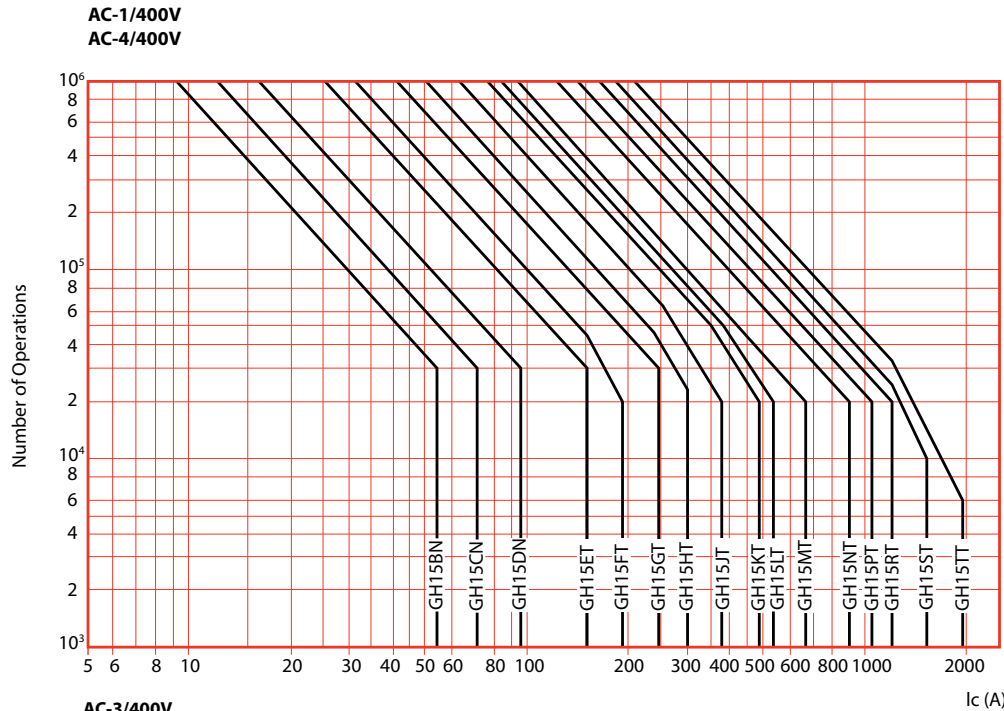

Note: Average durability curves are at 400V. For higher operational voltages, reduce the durability according following table.

Electrical Durability Curve Adjustment for Voltages Over 400V		
	AC-1 / AC-4	AC-3
400V	0%	0%
440V	10%	5%
500V	20%	10%
690V	40%	20%

GH15 Series Contactor Dimensions

Dimensions mm [inches]									
Contactor Model	Wide	High	Deep	Mounting					Product Weight kg [lb]
	A	B	C	D	E	E1	F	G	
GH15BN	45.0 [1.77]	80.0 [3.15]	85.0 [3.35]	35.0 [1.38]	60.0 [2.36]	7.5 [0.30]	116.0 [4.57]	12.0 [0.47]	0.41 [0.90]
GH15CN									
GH15DN									
GH15ET	45.0 [1.77]	80.0 [3.15]	91.0 [3.58]	35.0 [1.38]	60.0 [2.36]	7.5 [0.30]	122.0 [4.80]	12.0 [0.47]	0.47 [1.04]
GH15FT									
GH15GT	60.0 [2.36]	114.0 [4.49]	109.0 [4.29]	50.0 [1.97]	100.0 [3.94]	—	140.0 [5.51]	12.0 [0.47]	1.12 [2.47]
GH15HT									
GH15JT									
GH15KT	79.0 [3.11]	137.0 [5.39]	130.0 [5.12]	70.0 [2.76]	100.0 [3.94]	—	161.0 [6.34]	12.0 [0.47]	1.80 [3.97]
GH15LT									
GH15MT	79.0 [3.11]	162.0 [6.38]	130.0 [5.12]	70.0 [2.76]	100.0 [3.94]	—	161.0 [6.34]	12.0 [0.47]	2.20 [4.85]
GH15NT	110.0 [4.33]	170.0 [6.69]	162.0 [6.38]	100.0 [3.94]	130.0 [5.12]	—	193.0 [7.59]	12.0 [0.47]	4.00 [8.82]
GH15PT									
GH15RT	145.0 [5.71]	200.0 [7.87]	208.0 [8.19]	120.0 [4.72]	160.0 [6.30]	—	239.0 [9.41]	12.0 [0.47]	7.50 [16.53]
GH15ST									
GH15TT									

GH15BN, GH15CN, GH15DN, GH15ET, GH15FT

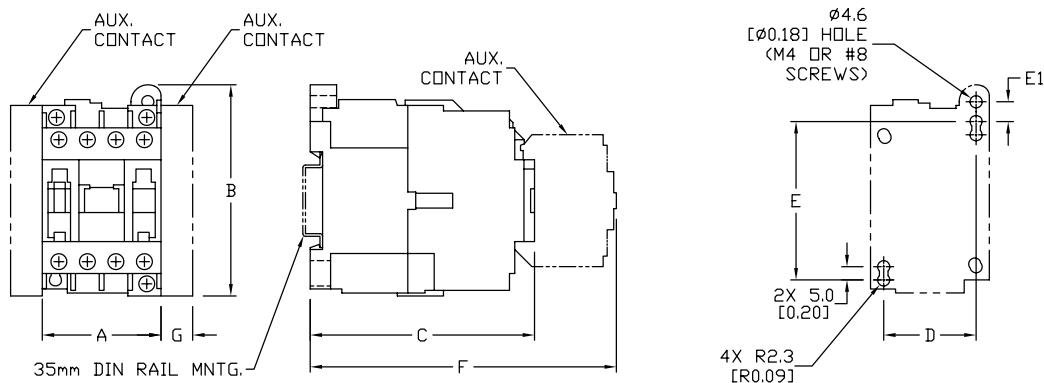

GH15GT, GH15HT, GH15JT

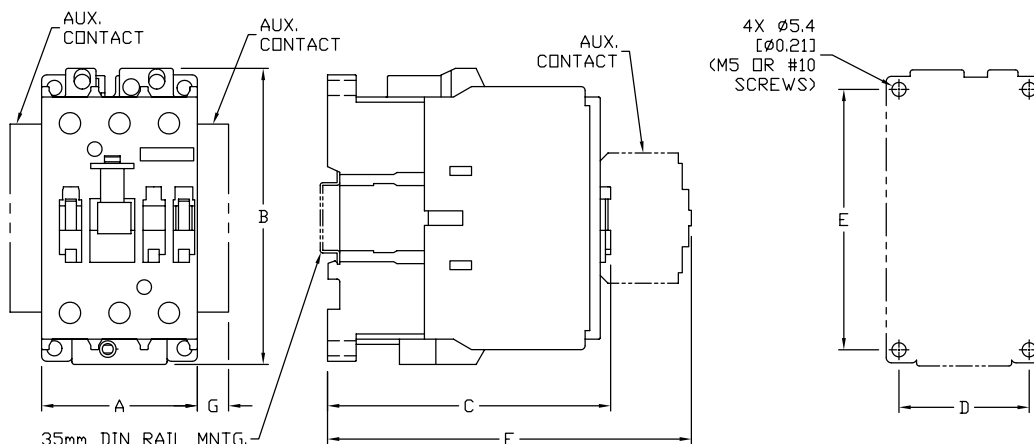

GH15 Series Contactor Dimensions

Dimensions

mm [in]

GH15KT, GH15LT, GH15MT

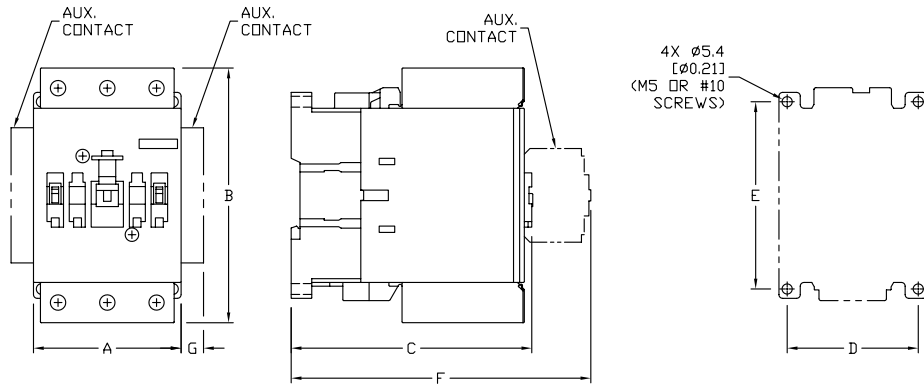

GH15NT and GH15PT

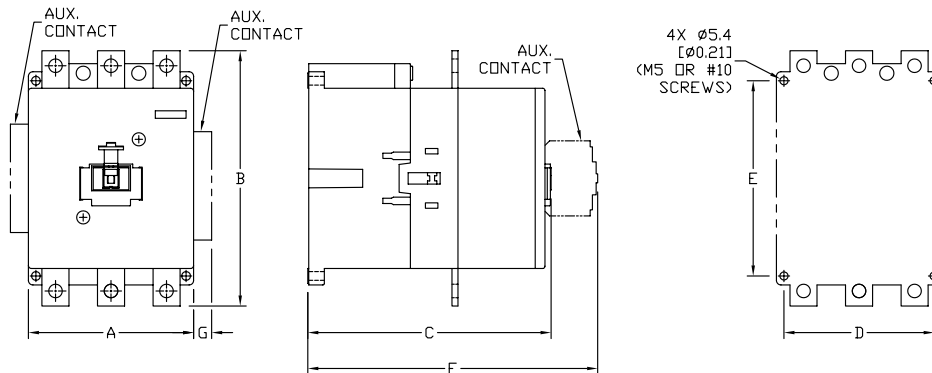

GH15RT, GH15ST, GH15TT

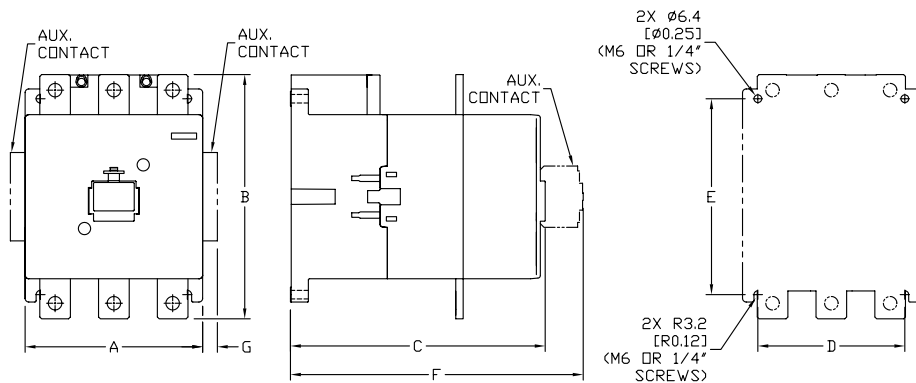

GH15 Series Mounting Positions

The correct mounting position is with the base plate in the vertical plane. The device can be mounted up to 25° from the vertical position.

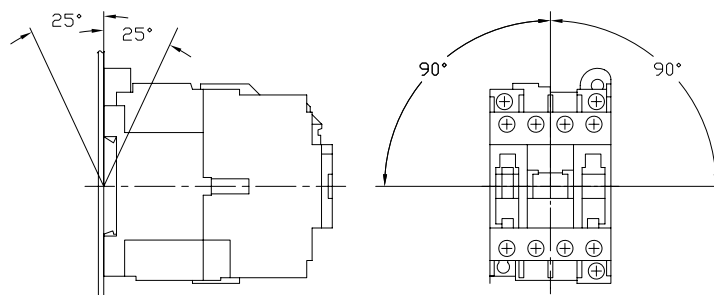

GH15 Series Contactor Accessories

Auxiliary contacts

Auxiliary contacts are designed for installation on all the GH15 series contactors. The snap-on design makes them quick and easy to install. The bifurcated contact blocks feature silver nickel alloy contacts.

Add up to 2 side-mounted auxiliary blocks (1 per side) plus 1 top-mounted auxiliary contact block per contactor max. This will equal up to 8 possible auxiliary contact configurations.

Auxiliary Contacts			
Part Number	Price	Description	Mounting
<u>GH15T11</u>	\$19.00	1 NO 1 NC	Top
<u>GH15T22</u>	\$25.00	2 NO 2 NC	Top
<u>GH15T31</u>	\$25.00	3 NO 1 NC	Top
<u>GH15T40</u>	\$25.00	4 NO	Top
<u>GH15S11</u>	\$22.00	1 NO 1 NC	Side

Contacts rated A600 per NEMA ICS 5-2000. For more info, refer to Control Circuit Contact Electrical Ratings.



Note: See contactor drawings page for dimensions

Auxiliary Contact Blocks

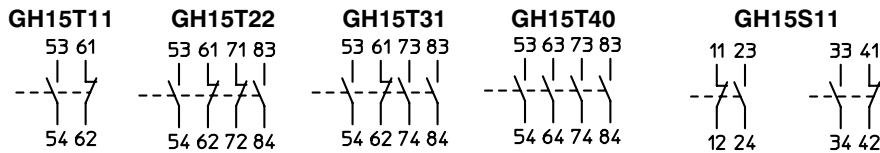

GH15 Series Contactor Accessories

Mechanical Interlock

Mechanical interlocks connect two contactors horizontally. When one contactor is energized, the other contactor is mechanically prohibited from making, even though it may be energized. The mechanical interlocks work with 45, 60, 79, 110 and 145 mm contactors.

Mechanical Interlock			
Part Number	Price	Description	Mounting
BM0H	\$12.00	Mechanical interlock, for use with GH15BN, GH15CN, GH15DN, GH15ET, GH15FT, GH15GT, GH15HT, GH15JT, GH15KT, GH15LT, or GH15MT series contactors.	Side
BM3H-AD	\$30.00	Mechanical interlock, for use with GH15NT, GH15PT, GH15RT, GH15ST or GH15TT series contactors.	Side

BM0H / BM3H-AD

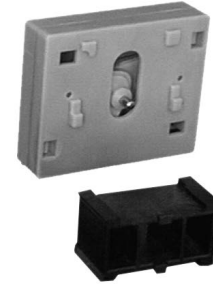

BM0H

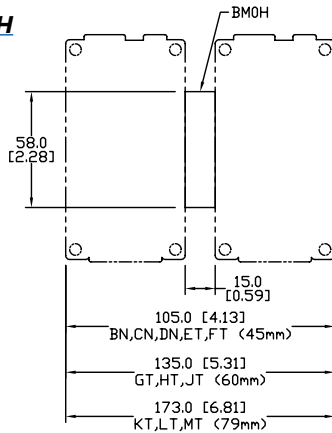

BM3H-AD

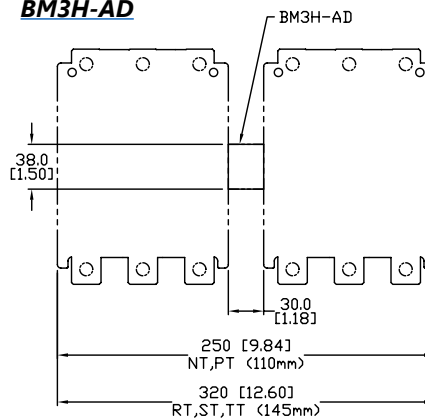

Terminal Screens

Terminal screens are for use with contactors and thermal overload relays to protect against accidental contact with live components.

Terminal Screens*				
Part Number	Price	Quantity	Description	Use With
PR37-AD	\$30.00	1 screen	Terminal screen, top or bottom, covers 3 poles. Use on line or load side. Mounting hardware included.	GH15NT GH15PT
PRT3-AD	\$30.00	1 screen	Terminal screen, top or bottom, covers 3 poles. Use on line or load side. Mounting hardware included.	GH15RT GH15ST GH15TT

* No additional protecting device is required for contactors up to IEC Size 79mm since the equipment by itself ensures IP20 frontal protection.
Note: Not for use with MR3-AD and KAL-4. See product insert for connections.

PRT3-AD



PR37-AD



Terminal Lug				
Part Number	Price	Quantity	Description	Use With
MR3-AD	\$14.00	1	Terminal lug, 1-pole, can hold (2) wires 5 AWG - 4/0 AWG.	GH15NT GH15PT RTD180
KAL-4	\$25.00	1	Terminal lug, 1-pole, can hold (1) wire 6 AWG - 300 MCM. Mounting hardware included.	GH15RT GH15ST GH15TT RTD320

MR3-AD



KAL-4



Adjustable Overloads For GH15 Series Contactors



The RTD series adjustable motor overload relays are designed for use with the GH15 Series 45 mm, 60 mm, 79 mm, 110 mm, and 145 mm contactors.

By combining the contactor with an overload relay, you have a reliable motor starter solution.

RTD32 overload relays for 45mm contactors

- 16 sizes for motor currents from 0.4 to 32 amps
- Units come with (1) N.O. and (1) N.C. auxiliary contacts
- Mount directly to 45mm contactors
- Class 10A trip class
- cULus listed, CE

RTD65 overload relays for 60mm contactors

- Four sizes for motor currents from 20 to 65 amps
- Units come with (1) N.O. and (1) N.C. auxiliary contacts
- Mount directly to 60mm contactors
- Class 10A trip class
- cULus listed, CE

RTD180 overload relays for 79mm and 110mm contactors

- 3 sizes for motor currents from 60 to 180 amps
- Units come with (1) N.O. and (1) N.C. auxiliary contacts
- Mount directly to 110mm contactors with connection links (included)
- Hard-wire connection to 79 mm contactors (No connection links available)
- Class 10A trip class
- cULus listed, CE

RTD320 overload relays for 145mm contactors

- 2 sizes for motor currents from 144 to 320 amps
- Units come with (1) N.O. and (1) N.C. auxiliary contacts
- Mount directly to 145mm contactors with connection links (included)
- Class 10A trip class
- cULus listed, CE



GH15 Series Adjustable Overload Relay Features

RTD32
for 45 mm Contactors

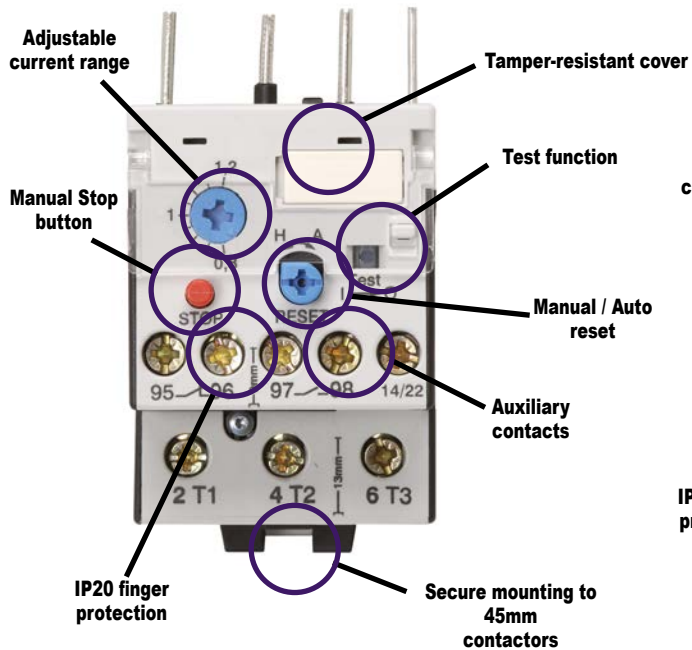

Note: Scale is 1:1 on dial.

RTD180 for 79 mm and 110 mm Contactors

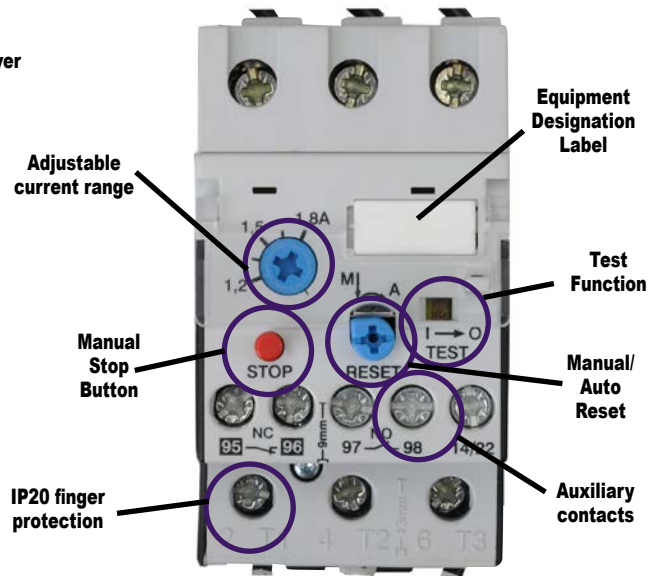

Note: The secondary current for the dial adjustment of the relay is 100x the dial current. For example, for a rated load current of 120A, the relay setting should be 1.2A.

RTD65
for 60 mm Contactors

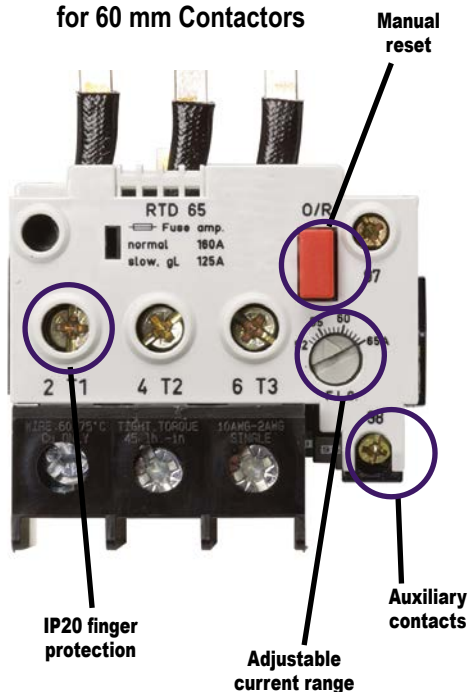

Note: Scale is 1:1 on dial.

Note: Additional Black Loadside Terminal Block is available on RTD65-5200 and RTD65-6500 only.

RTD320
for 145 mm Contactors

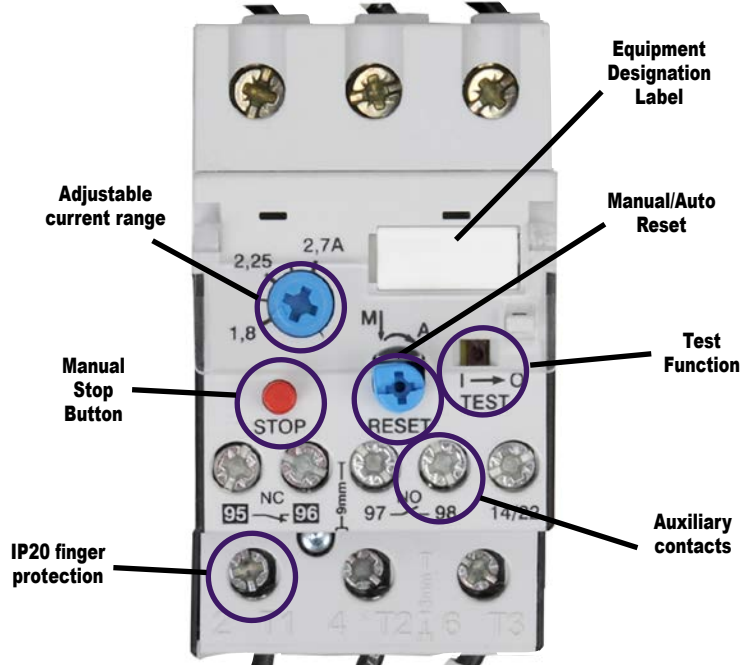

Note: The secondary current for the dial adjustment of the relay is 80x the dial current. For example, for a rated load current of 216A, the relay setting should be 2.7A.

GH15 Series Overload Relay Selection Guide

- Step 1** Determine the motor FLA and service factor listed on the motor name plate. Next, calculate the size overload protection required based on 2005 NEC 430.32. Select your motor's FLA (Full Load Amperage) from Column A. Tripping current occurs at 125% of FLA in column A.
- Step 2** Follow across to Column B to find your contactor size. Check the maximum amperage rating for that contactor. Ranges overlap and you may have to go to the next larger size.
- Step 3** After selecting your contactor, follow across to Column C to find your overload relay model number.
- Step 4** Order the contactor and overload relay, any desired auxiliary contacts, then assemble and install your motor starter.

Motor Contactor and Overload Relay Selection Guide (When Motor FLA is Known)				
A	B	C	Price	IEC Contactor Frame Size
Current Range Motor FLA	Contactor Model	Overload Relay		
0.4 to 0.6A	GH15BN up to maximum FLA of 9A	RTD32-60	\$74.00	45mm
0.6 to 0.9A		RTD32-90	\$74.00	
0.8 to 1.2A		RTD32-120	\$74.00	
1.2 to 1.8A		RTD32-180	\$74.00	
1.8 to 2.7A		RTD32-270	\$74.00	
2.7 to 4.0A		RTD32-400	\$74.00	
4.0 to 6.0A		RTD32-600	\$74.00	
6.0 to 9.0A		RTD32-900	\$74.00	
8.0 to 11.0A		GH15CN up to 12A FLA	RTD32-1100	
10.0 to 14.0A	RTD32-1400		\$79.00	
10.0 to 14.0A	GH15DN up to 16A FLA	RTD32-1400	\$79.00	
13.0 to 18.0A		RTD32-1800	\$79.00	
13.0 to 18.0A	GH15ET up to 25A FLA	RTD32-1800	\$79.00	
17.0 to 24.0A		RTD32-2400	\$79.00	
22.0 to 32.0A		RTD32-3200	\$93.00	
22.0 to 32.0A	GH15FT up to 32A FLA	RTD32-3200	\$93.00	
20.0 to 28.0A	GH15GT up to 40A FLA	RTD65-2800	\$135.00	60mm
28.0 to 42.0A		RTD65-4200	\$135.00	
28.0 to 42.0A	GH15HT up to 50A FLA	RTD65-4200	\$135.00	
40.0 to 52.0A		RTD65-5200	\$168.00	
40.0 to 52.0A	GH15JT up to 63A FLA	RTD65-5200	\$168.00	
52.0 to 65.0A		RTD65-6500	\$168.00	
60.0 to 90.0A	GH15KT up to 80A FLA	RTD180-9000	\$237.00	79mm
60.0 to 90.0A	GH15LT up to 95A FLA	RTD180-9000	\$237.00	
80.0 to 120.0A	GH15MT up to 110A FLA	RTD180-12000	\$302.00	110mm
120.0 to 180.0A	GH15NT up to 150A FLA	RTD180-18000	\$324.00	
120.0 to 180.0A	GH15PT up to 175A FLA	RTD180-18000	\$324.00	
144.0 to 216.0A	GH15RT up to 210A FLA	RTD320-21600	\$375.00	145mm
144.0 to 216.0A	GH15ST up to 260A FLA	RTD320-21600	\$375.00	
216.0 to 320.0A		RTD320-32000	\$375.00	
144.0 to 216.0A	GH15TT up to 315A FLA	RTD320-21600	\$375.00	
216.0 to 320.0A		RTD320-32000	\$375.00	

GH15 Series Contactors Overload Technical Characteristics

Typical Trip Curves

45mm and 60mm Overloads

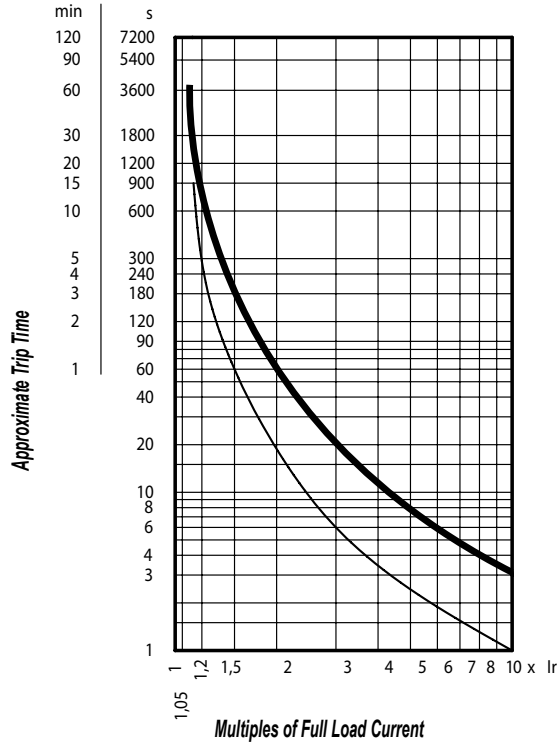

Note: Curves show tripping time (average value) versus multiples of setting current I_r .

— Tripping starting from cold
 — Tripping starting from hot

79mm, 110mm, and 145mm Overloads

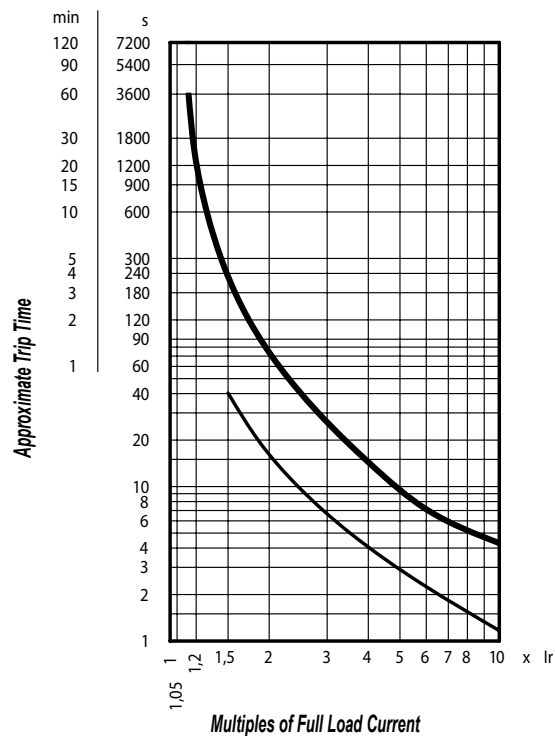

GH15 Series Contactors Overload Technical Characteristics

Thermal Overload Relays Specifications					
	RTD32	RTD65	RTD180	RTD180-18000	RTD320
Storage temperature	-40 to +70°C (-40°F to 158°F)				
Operating temperature	-25 to +55°C (-13°F to 131°F)				
Tripping class IEC 60947-4-1	10A				
Phase loss sensitive	Yes				
Connection to contactor	Built-in links		Pass through wire	Links for direct	Links for direct
Frequency limits	0-400 Hz		50-60 Hz		
Power dissipation per phase	2.3 Watts	3.7 Watts (52-65 A) setting range: 4.5 W	3 Watts		5 Watts
Short circuit current rating 600V	5kA rms				
Aux contacts wire range	14-10 AWG				
Aux contacts tightening torque	8.1 lb·in				

Overload Aux Contact Ratings					
Contact Rating Code Designation	Thermal Continuous Current (Amps)	Maximum Current (Amps)			
		120 Volt	240 Volt	480 Volt	600 Volt
		Make / Break	Make / Break	Make / Break	Make / Break
95-96 (NC) B600	5	30 / 3	15 / 1.5	7.5 / 0.75	6 / 0.6
97-98 (NO) C600	2.5	15 / 1.5	7.5 / 0.75	3.75 / 0.375	3 / 0.3

IEC Terminal Designations

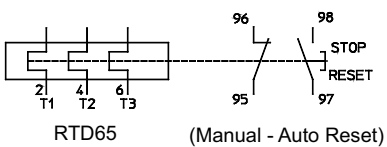
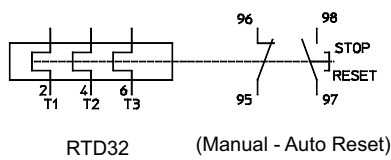

Wiring Diagrams

RTD32 / RTD65

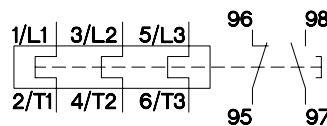

RTD180 / RTD320

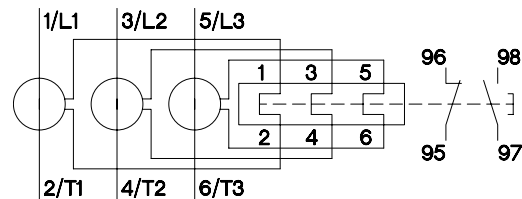

GH15 Series Overload Relay Dimensions

45mm Contactor and Overload Dimensions

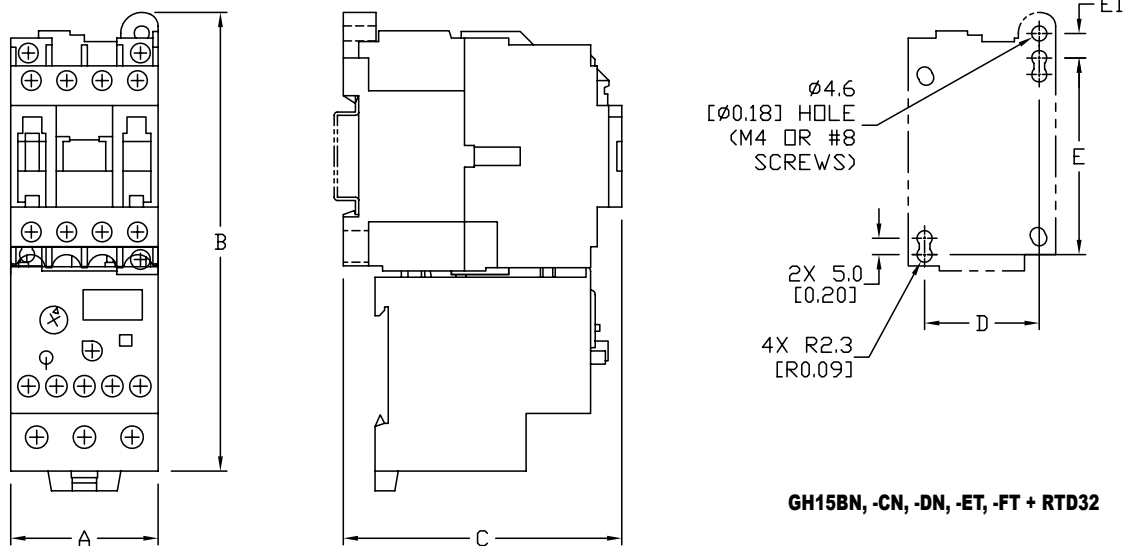

Overload Dimensions mm [in]													
Contactor Model	Overload Model	Width		Height		Depth C	D	E	E1	F	G	H	I
		A	B	B1	B2								
GH15BN	RTD32	45.0 [1.77]	146.0 [5.75]	-	-	85.0 [3.35]	35.0 [1.38]	60.0 [2.36]	7.5 [0.30]	-	-	-	-
GH15CN													
GH15DN													
GH15ET													
GH15FT	RTD65	68.5 [2.70]	169.0 [6.65]	-	-	109.0 [4.29]	50.0 [1.97]	100.0 [3.94]	-	-	-	-	-
GH15GT													
GH15HT													
GH15JT													
GH15KT	RTD180	128.0 [5.04]	contactor and overloads do not have a link connector	137.0 [5.39]	81.0 [3.19]	130.0 [5.12]	70.0 [2.76]	100.0 [3.94]	-	-	68.0 [2.68]	40.0 [1.57]	-
GH15LT				162.0 [6.38]	81.0 [3.19]								
GH15MT													
GH15NT	RTD180-18000	128.0 [5.04]	290.0 [11.42]	-	-	145.0 [5.71]	100.0 [3.94]	130.0 [5.12]	-	42.5 [1.67]	68.0 [2.68]	40.0 [1.57]	-
GH15PT													
GH15RT	RTD320	145.0 [5.71]	361.0 [14.21]	-	-	208.0 [8.19]	120.0 [4.72]	160.0 [6.30]	-	80.0 [3.15]	68.0 [2.68]	40.0 [1.57]	96.0 [3.78]
GH15ST													
GH15TT													

GH15 Series Overload Relay Dimensions

60mm Contactor and Overload Dimensions

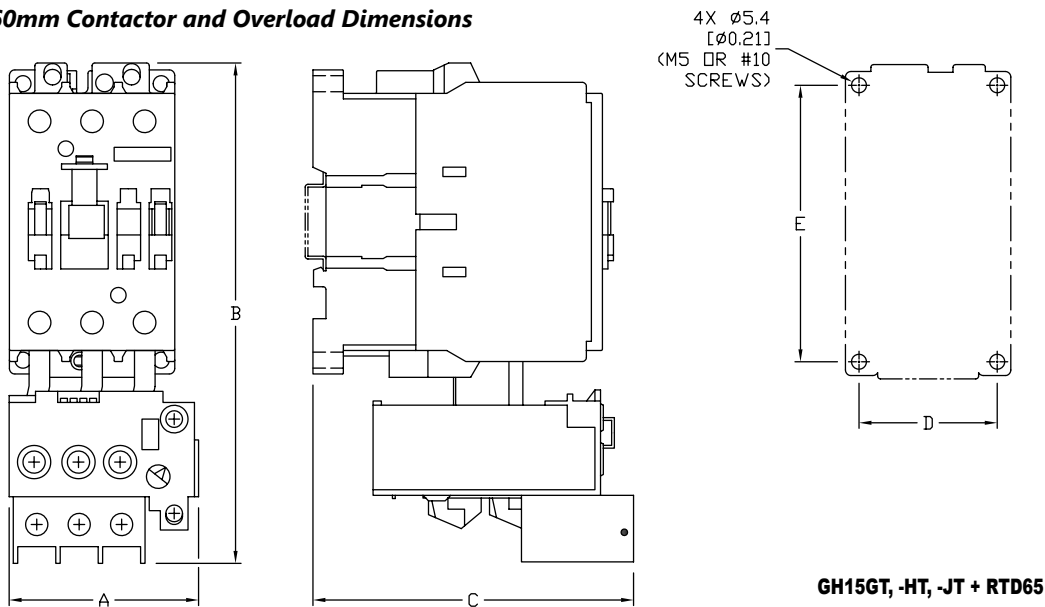

79mm Contactor and Overload Dimensions

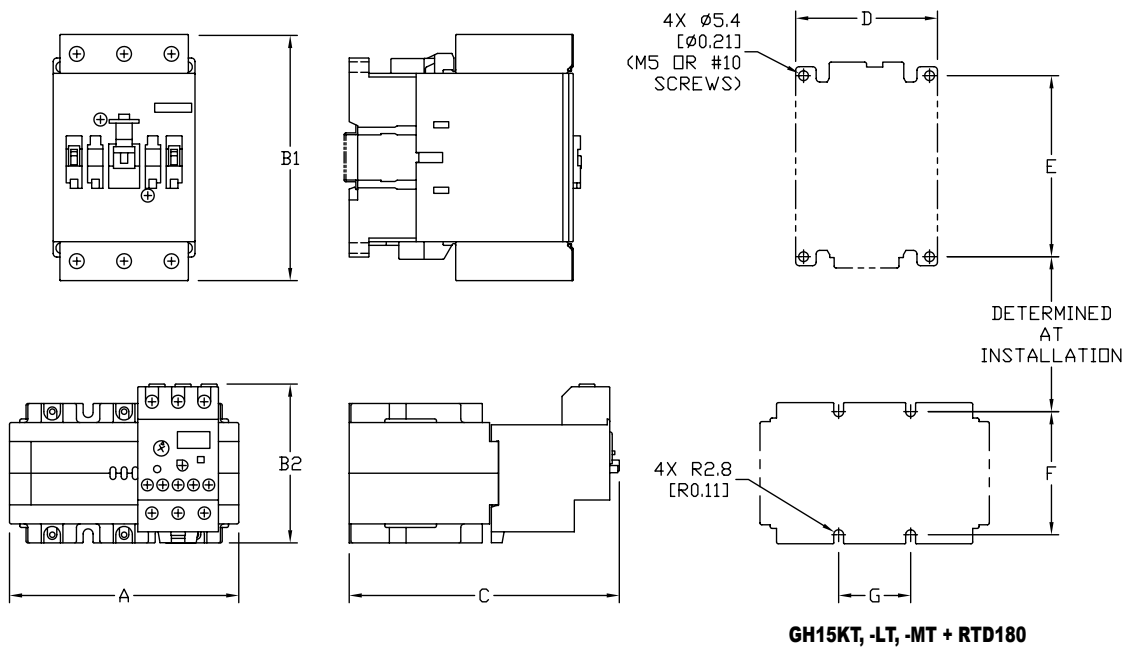

Note: See our website www.automationdirect.com for complete engineering drawings

GH15 Series Overload Relay Dimensions

110mm Contactor and Overload Dimensions

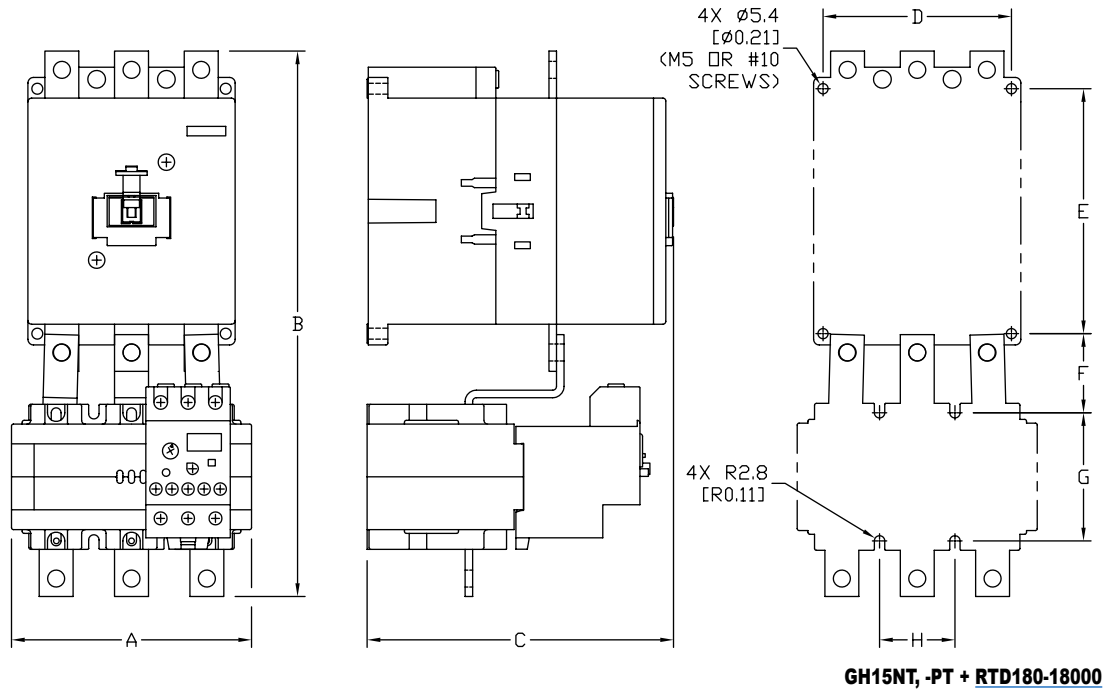

145mm Contactor and Overload Dimensions

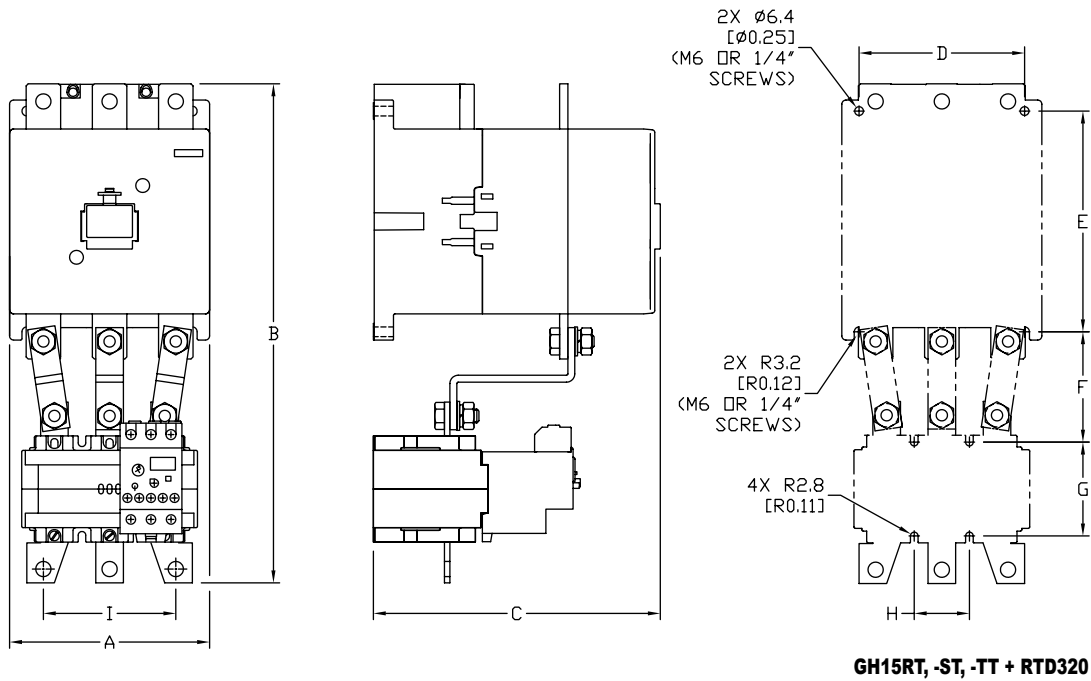

Note: See our website www.automationdirect.com for complete engineering drawings