

# Fuji Duo Series Manual Motor Starters Accessories

## Busbar system

### Features

- The busbar system reduces wiring time and saves floor space.
- The busbar makes it easy to power from 2 to 5 manual motor starters, with no wiring needed.
- The 3-phase feed-in terminals are used to connect the wire for the power supply circuit.
- The busbar cover guards against accidental touching of nonconnected busbar terminals (charged parts).
- If using BZ0TCRE terminal cover with BM3R series MMS, the busbar system can not be used.

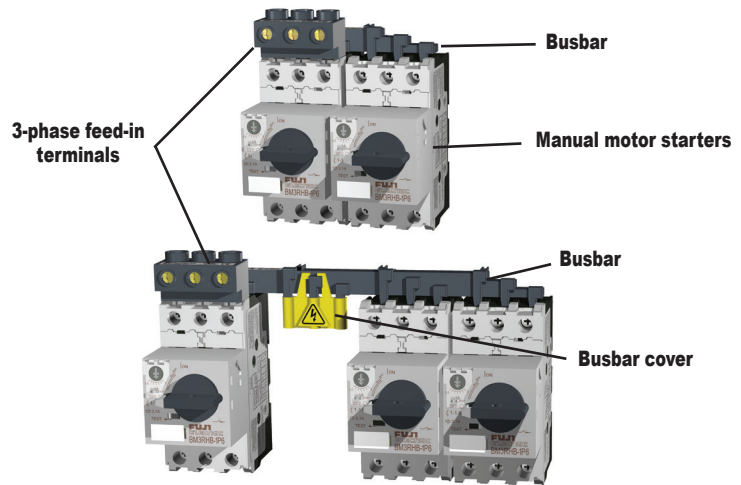

Note: Busbar photos continued on next page.



Busbar System Components and Ratings								
Part Number	Price	Description	Used with	Specifications	Weight (g)			
<a href="#">BZ0BR02A</a>	\$23.00	Busbar	BM3R	Continuous current: 64A max. pin connection	2-BM3R, modular space: 45mm	30		
<a href="#">BZ0BR03A</a>	\$20.50				3-BM3R, modular space: 45mm	50		
<a href="#">BZ0BR04A</a>	\$24.50				4-BM3R, modular space: 45mm	70		
<a href="#">BZ0BR05A</a>	\$26.00				5-BM3R, modular space: 45mm	90		
<a href="#">BZ0BR12A</a>	\$19.50				2-BM3R, modular space: 54mm	30		
<a href="#">BZ0BR13A</a>	\$23.50		BM3R+ 1 external accessory, 9mm wide	Continuous current: 126A max. pin connection	3-BM3R, modular space: 54mm	55		
<a href="#">BZ0BR14A</a>	\$26.00				4-BM3R, modular space: 54mm	80		
<a href="#">BZ0BR15A</a>	\$27.50				5-BM3R, modular space: 54mm	105		
<a href="#">BZ0BV02A</a>	\$37.00				BM3V	Continuous current: 126A max. pin connection	2-BM3V, modular space: 55mm	140
<a href="#">BZ0BV03A</a>	Retired						3-BM3V, modular space: 55mm	240
<a href="#">BZ0BV04A</a>	\$55.00		4-BM3V, modular space: 55mm	340				
<a href="#">BZ0BV12A</a>	\$39.50		2-BM3V, modular space: 64mm	150				
<a href="#">BZ0BV13A</a>	Retired		3-BM3V, modular space: 64mm	270				
<a href="#">BZ0BV14A</a>	Retired		BM3V + 1 external accessory, 9mm wide	Continuous current: 64A max. Applicable cable size: 25mm <sup>2</sup> max.	4-BM3V, modular space: 64mm	380		
<a href="#">BZ0BFRA</a>	\$20.50		3-phase feed-in terminal		BM3R	Continuous current: 126A max. Applicable cable size: 50mm <sup>2</sup> max.	40	
<a href="#">BZ0BFVA</a>	\$41.50	BM3V			170			
<a href="#">BZ0BCRA</a>	\$5.50	Busbar cover	BZ0BR		For pin connection	10		
<a href="#">BZ0BCVA</a>	Retired		BZ0BV	NOTE: Some fine tuning and fitting adjustments may be needed.	5			

# Fuji Duo Series Manual Motor Starters

## Accessories

### Busbar system (continued)

### Dimensions

(mm)

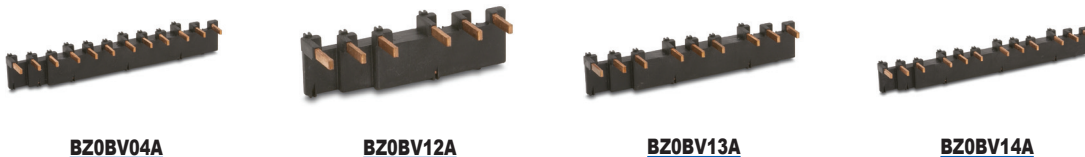

For BM3RHB-xxx

BZ0BR0xx Without external accessory

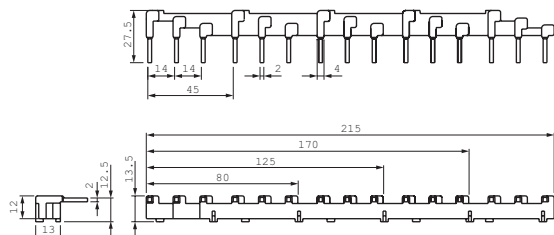

- BZ0BR02A: 80 mm
- BZ0BR03A: 125 mm
- BZ0BR04A: 170 mm
- BZ0BR05A: 215 mm

BZ0BR1xx With 1 external accessory

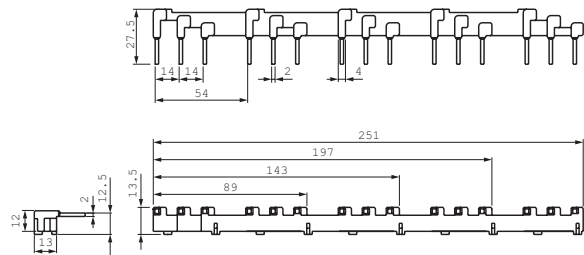

- BZ0BR12A: 89 mm
- BZ0BR13A: 143mm
- BZ0BR14A: 197 mm
- BZ0BR15A: 251 mm

BZ0BFRA 3-phase feed-in terminals

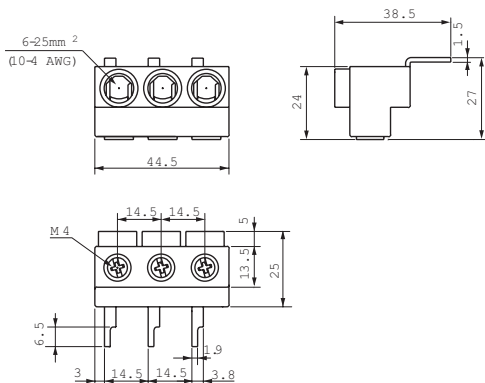

For BM3VHB-xxx

BZ0BV0xx Without external accessory

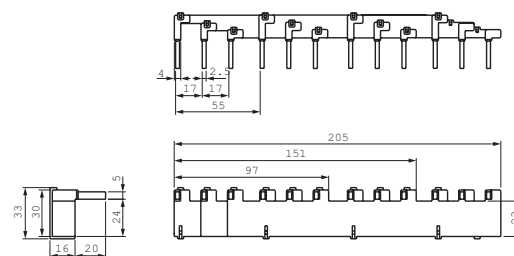

- BZ0BV02A: 97 mm
- BZ0BV03A: 151 mm
- BZ0BV04A: 205 mm

BZ0BV1xx With 1 external accessory, 9mm wide

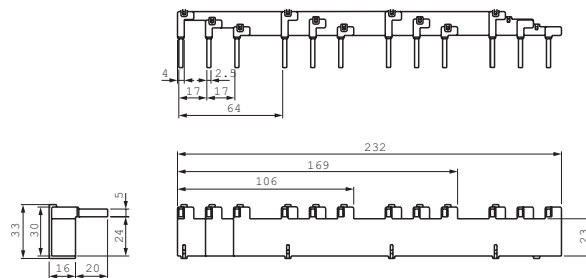

- BZ0BV12A: 106 mm
- BZ0BV13A: 169 mm
- BZ0BV14A: 232 mm

BZ0BFVA

