

Fuji Duo Series TK-E Overload Relays

TK-E series thermal overload relays with open-phase protective device

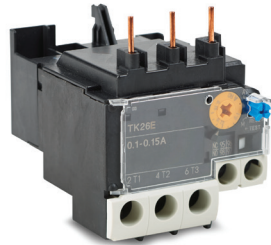

TK26E-P10



TK-E-800



TK-E-5000



TK-E-4000

Features

- This relay protects motor windings from burning due to overloads, locked rotor current, or open-phases
- Maintenance and inspection safety has been improved by employing a finger protection mechanism to cover exposed terminals (conforms to DIN 57106, VDE 0106 Teil 100)
- Isolated NO and NC contacts can be used with different potentials
- A high-precision scale for the current adjustment dial enables easy and exact current setting
- The operating status can be visually checked with ease
- The relays can be manually tripped. A trip-free mechanism is also provided
- Base unit can be added to enable separate mounting of the TK26E, E2, and E3-xxx models

Standards

- UL listed, file E44592, Standard UL 508
- cUL listed, file E44592, CSA C22.2 No. 14
- IEC 60947-4-1, EN60947-4-1
- VDE 0660, JIS C 8201-4-1
- CE Compliant



TK26E Series Overloads			
Part Number	Price	Amperage Adjustment Range (A)	Frame Width / Contactor
TK26E-P10	\$35.50	0.1 - 0.15	43mm
TK26E-P13	\$35.50	0.13 - 0.2	
TK26E-P18	\$35.50	0.18 - 0.27	
TK26E-P24	\$35.50	0.24 - 0.36	
TK26E-P34	\$35.50	0.34 - 0.52	
TK26E-P48	\$35.50	0.48 - 0.72	
TK26E-P64	\$35.50	0.64 - 0.96	
TK26E-P80	\$35.50	0.8 - 1.2	
TK26E-P95	\$35.50	0.95 - 1.45	
TK26E-1P1	\$34.00	1.1-1.65	
TK26E-1P4	\$35.50	1.4 - 2.1	
TK26E-1P7	\$35.50	1.7 - 2.6	
TK26E-2P2	\$35.50	2.2 - 3.4	
TK26E-2P8	\$35.50	2.8 - 4.2	
TK26E-004	\$35.50	4.0 - 6.0	
TK26E-005	\$35.50	5.0 - 7.5	
TK26E-006	\$35.50	6.0 - 9.0	
TK26E-007	\$35.50	7.0 - 10.5	
TK26E-009	\$35.50	9.0 - 13.0	
TK26E-012	\$35.50	12 - 18	
TK26E-016	\$35.50	16 - 22	
TK26E-020	\$35.50	20 - 26	

TK-E Series Overloads			
Part Number	Price	Amperage Adjustment Range (A)	Frame Width / Contactor
TK-E-600	\$59.00	4 - 6	54mm
TK-E-800	\$59.00	5 - 8	
TK-E-900	\$59.00	6 - 9	
TK-E-1100	\$59.00	7 - 11	
TK-E-1300	\$59.00	9 - 13	
TK-E-1800	\$59.00	12 - 18	
TK-E-2600	\$59.00	18 - 26	
TK-E-3600	\$59.00	24 - 36	
TK-E-4200	\$59.00	32 - 42	
TK-E-5000	\$59.00	40 - 50	
TK-E-5400	\$59.00	44 - 54	
TK-E-1800	\$72.00	12 - 18	67mm
TK-E-2600	\$72.00	18 - 26	
TK-E-3600	\$72.00	24 - 36	
TK-E-4000	\$72.00	28 - 40	
TK-E-5000	\$72.00	34 - 50	
TK-E-6500	\$72.00	45 - 65	
TK-E-6800	\$72.00	48 - 68	
TK-E-8000	\$72.00	64 - 80	
TK-E-5000	\$81.00	34 - 50	
TK-E-6500	\$81.00	45 - 65	
TK-E-9500	\$81.00	65 - 95	
TK-E-10500	\$81.00	85 - 105	
TK-E-8000	\$139.00	53 - 80	100mm/115mm
TK-E-9500	\$139.00	65 - 95	
TK-E-12500	\$139.00	85 - 125	
TK-E-16000	\$139.00	110 - 160	

Fuji Duo Series Contactor and Overload Relay Selection Tables

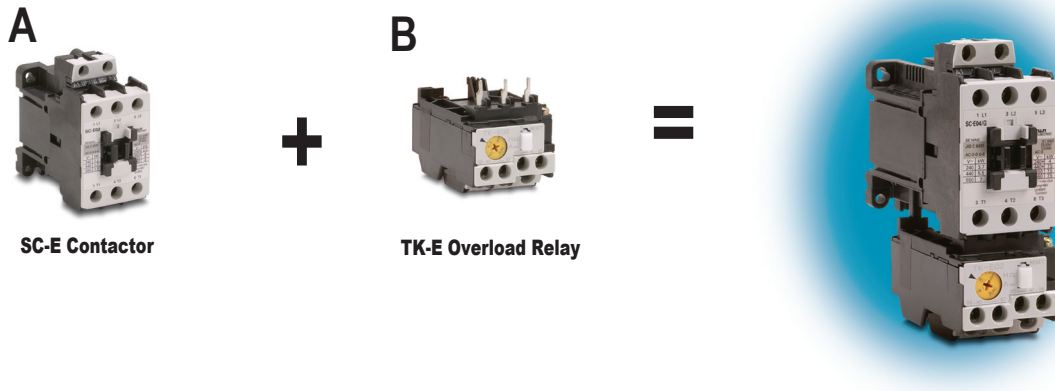

100-240V Single Phase Motor (1/3 to 25 hp)

Step 1. Using the "SC-E Series Contactors" table, select a contactor based on motor voltage and horsepower.

Step 2. Using the "TK26E Series Overloads" or "TK-E Series Overloads" table, select an overload relay based on motor full load current.

Check the data plate on the motor for the hp, volts and full-rated amps.

Motor							
HP	5	Volts	460	Phase	3	Type	P
RPM	1725	Amps	7.6	Hz	60	SF	1.15
Design	B	AMB	40°C	Insul Class		F	
Duty	Cont	Encl	TEFC	Code		K	

Motor horsepower (points to HP)

Motor voltage (points to Volts)

Motor full-load rated amperage (FLA) (points to Amps)

Three Phase Motors - Refer to tables on following page

Step 1. Select a SC-E contactor from Column A based on motor voltage and horsepower.

Step 2. Select a TK-E overload relay from Column B to work with the SC-E contactor selected in Step 1. The motor full load current (FLA) should be within the adjustable current range of the overload relay.

Fuji Duo Series Overload Relay Selection Tables

220-240V 3-Phase Motor (0.5 to 50hp)¹

Overload Relay Selection for 220–240V 3-phase motors				
Motor Rating		A	B	
Motor HP	Motor Full Load Amperage (FLA) ²	Contactor	Overload Relay	
			Part Number	Adjustable Current Range
1/2	2.2	SC-E02-xxxx	TK26E-1P7	1.7 to 2.6A
3/4	3.2		TK26E-2P8	2.8 to 4.2A
1	4.2		TK26E-004	4 to 6A
1-1/2	6		TK26E-005	5 to 7.5A
2	6.8		TK26E-006	6 to 9A
3	9.6	SC-E03-xxxx	TK26E-009	9 to 13A
5	15.2	SC-E04-xxxx	TK26E-012	12 to 18A
7-1/2	22	SC-E05-xxxx	TK26E-020	20 to 26A
10	28	SC-E1-xxxx	TK-E2-3600	24 to 36A
15	42	SC-E2-xxxx	TK-E2-4200	32 to 42A
20	54	SC-E3-xxxx	TK-E3-6500	45 to 65A
25	68	SC-E4-xxxx	TK-E3-6800	48 to 68A
30	80	SC-E5-xxxx	TK-E5-9500	65 to 95A
40	104	SC-E6-xxxx	TK-E6-12500	85 to 125A
50	130	SC-E7-xxxx	TK-E6-16000	110 to 160A

Note 1: For 220-240 V three-phase motors up to 150 hp refer to the Fuji Odyssey series.

Note 2: Per NEC 2017 table 430.250 column for 230VAC

440-480V 3-Phase Motor (0.5 to 100hp)¹

Overload Relay Selection for 440–480V 3-phase motors				
Motor Rating		A	B	
Motor HP	Motor Full Load Amperage (FLA) ²	Contactor	Overload Relay	
			Part Number	Adjustable Current Range
1/2	1.1	SC-E02-xxxx	TK26E-P95	0.95 to 1.45A
3/4	1.6	SC-E02-xxxx	TK26E-1P1	1.1 to 1.65A
3/4	1.6	SC-E02-xxxx	TK26E-1P4	1.4 to 2.1A
1	2.1	SC-E02-xxxx	TK26E-1P7	1.7 to 2.6A
1-1/2	3.0	SC-E02-xxxx	TK26E-2P8	2.8 to 4.2A
2	3.4	SC-E02-xxxx	TK26E-2P8	2.8 to 4.2A
3	4.8	SC-E02-xxxx	TK26E-004	4 to 6A
5	7.6	SC-E02-xxxx	TK26E-006	6 to 9A
7 1/2	11	SC-E03-xxxx	TK26E-009	9 to 13A
10	14	SC-E04-xxxx	TK26E-012	12 to 18A
15	21	SC-E05-xxxx	TK26E-020	20 to 26A
20	27	SC-E1-xxxx	TK-E2-3600	24 to 36A
25	34	SC-E1-xxxx	TK-E2-4200	32 to 42A
30	40	SC-E2-xxxx	TK-E2-4200	32 to 42A
40	52	SC-E3-xxxx	TK-E3-6500	45 to 65A
50	65	SC-E4-xxxx	TK-E3-6800	48 to 68A
60	77	SC-E5-xxxx	TK-E5-9500	65 to 95A
75	96	SC-E6-xxxx	TK-E6-12500	85 to 125A
100	124	SC-E7-xxxx	TK-E6-16000	110 to 160A

Note 1: For 440-480V three-phase motors up to 300 hp refer to the Fuji Odyssey series.

Note 2: Per NEC 2017 table 430.250 column for 460VAC

Fuji Duo Series TK-E Overload Relays

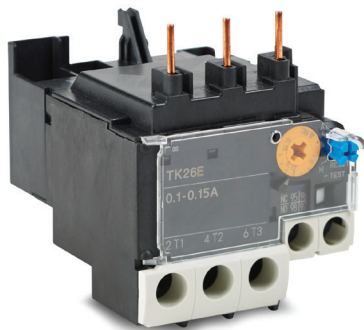

TK26E-P10

Standard Operating Conditions	
Ambient Temperature	Operating: -10 to +55°C No sudden temperature changes resulting in condensation or icing (The average temperature over a 24-hour period must not exceed 35°C) Storage: -40 to 65°C
Humidity	45 to 85% RH
Atmosphere	No excessive dust, smoke, corrosive gases, flammable gases, steam, or salt
Vibration	10 to 55Hz, 15m/s ²
Shock	50m/s ²
Mounting	Vertical, permissive angle 30 degrees

Specifications							
Model	Applicable Contactor Non-reversing	Auxiliary Contact	Trip Class IEC 60947-4-1	Number of Heater Elements	Power Consumption per Pole (VA)	SCCR (kA)	Features
TK26E-xxx	SC-E02(G), E03(G), E04(G), E05(G)-xxx	1NO+1NC	10A	3	1.7	5	Overload, open-phase protection Ambient temperature compensation Manual/auto reset selectable Manual trip mechanism Trip indicator
TK-E2-xxx	SC-E1(G), E2(G), E2S(G)-xxx				3.8	5	
TK-E3-xxx	SC-E3(G), E4(G)-xxx				6.6	5	
TK-E5-xxx	SC-E5-xxx				6.6	10	
TK-E6-xxx	SC-E6, E7-xxx				8.0	10	

Auxiliary Contact Ratings - UL and CSA						
Model	Rated Insulation Voltage (V)	NEMA ICS 5-2000 Ratings (note 1)				
		AC Ratings (Max)			DC Ratings (Max)	
		Designation	Making VA	Breaking VA	Designation	Making/Breaking VA
TK26E-xxx to TK-E6-xxx	600	B600	3600	360	R300	28

Notes:

1. NEMA ICS 5-2000. For more information, refer to Control Circuit Contact Electrical Ratings, page MRC-111.

Auxiliary contact ratings - JIS and IEC							
Model	Rated Insulation Voltage (A)	Rated Thermal Current (A)	Rated Operational Current (A)				Minimum Voltage and Current
			AC Voltage (V)	AC15 (Ind. load)	DC Voltage (V)	DC13 (Ind. load)	
TK26E-xxx	690	5	24	3 (0.5) *	24	1.1 (0.3)	5VDC, 3mA
			100-120	2.5 (0.5) *	100-120	0.28	
			200-240	2 (0.5) *	200-240	0.14	
			380-440	1 (0.5) *			
			500-600	0.6 (0.5) *			
TK-E2-xxx	690	5	24	3 (0.5) *	24	1.1 (0.3)	3VDC, 5mA
TK-E3-xxx			100-120	2.5 (0.5) *	100-120	0.28	
TK-E5-xxx			200-240	2 (0.5) *	200-240	0.14	
TK-E6-xxx			380-440	1 (0.5) *			
			500-600	0.6 (0.5) *			

Note: * In case of auto-reset type NO contact.

Fuji Duo Series TK-E Overload Relays

Wiring

Be sure to wire the relays correctly using the wiring diagrams on the supplied installation sheets. Main terminals for models TK26E-xxx to TK-E6-xxx are wired using solid wires or stranded wires. Stranded wires or flexible stranded wires can be connected by twisting them together and crimping a sleeve (ferrule) onto them before connecting.

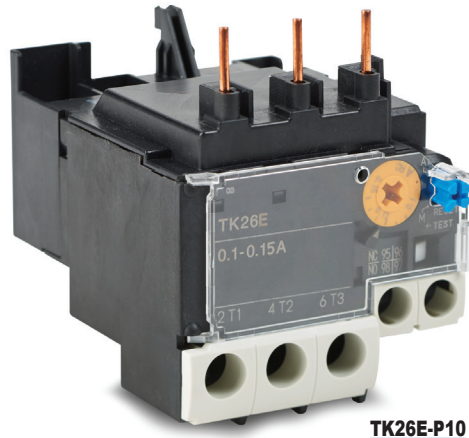



TK26E-P10

Tightening torque

If wires are not tightened sufficiently, they may become hot or loosen and result in a fire, short-circuit, electric shock, or some other potentially dangerous situation. Be sure to tighten the wires to the torques specified in these tables.

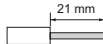
Wire Sizes, Tightening Torques - Main Circuit

Thermal Overload Relay Model	TK-E2-xxx	TK-E3-xxx	TK-E5-xxx	TK-E6-xxx
Single Stranded Wire (mm ²)	0.75 to 16	1.5 to 35	1.5 to 35	16 to 70
Flexible Stranded Wire with Sleeve (mm ²)	0.75 to 16	1.5 to 35	1.5 to 35	16 to 70
Flexible Stranded Wire without Sleeve (mm ²)	0.75 to 16	1.5 to 35	1.5 to 35	16 to 70
AWG 75°C Cu only	6 max.	2 max.	2 max.	00 max.
Insulation Stripping Length				
Tool	Phillips screwdriver, H-type, No. 2 (ISO 8764); ADC part number TW-SD-VPH-2	Hex. wrench 4 (ISO 2936)		
	Flat-blade screwdriver, 1 x 5.5 x L-type, B (ISO 2830); ADC part number TW-SD-VSL-4			
Tightening Torque (N•m)	2.5	6	10	

Note: Stranded wire (0 to 25mm²) consists of 7 wires or less. Stranded wire (35 to 120mm²) consists of 19 wires or less. Flexible stranded wire consists of more wires than the above.

Wire Sizes, Tightening Torques - Main Circuit

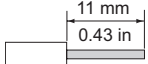
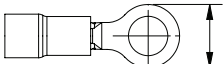
Thermal Overload Relay Type	TK26E-xxx	
Solid Wire (mm ²)	One	0.75 to 4
	Two	1 to 4
Stranded Wire (mm ²)	One	0.75 to 4
	Two	1 to 4
AWG 75°C Cu only	One	18 to 12
	Two	18 to 12
Insulation Stripping Length (mm)		
Maximum Crimp Terminal Width		Max. 9.7 mm (0.38 inches) wide
Terminal Screw Size	M4	
Tool	Phillips screwdriver, H-type, No. 2 (ISO 8764); ADC part number TW-SD-VPH-2	
	Flat-blade screwdriver, 1 x 5.5 x L-type, B (ISO 2830); ADC part number TW-SD-VSL-4	
Tightening Torque [N•m (lb•in)]	1.2 to 1.5 (11 to 13)	

Wire Sizes, Tightening Torques - Control Circuit

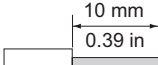
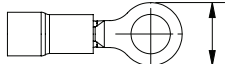
Single Stranded Wire (mm ²)	One	0.75 to 2.5 (ø 1 to ø 1.6)
	Two	0.75 to 2.5
AWG 75°C Cu only	One	18 to 14
	Two	18 to 14
Insulation Stripping Length (mm)		
Maximum Crimp Terminal Width		Max. 7.7 mm (0.30 in) wide (R2-3.5)
Terminal Screw Size	M3.5	
Tool	Phillips screwdriver, H-type, No. 2 (ISO 8764); ADC part number TW-SD-VPH-2	
	Flat-blade screwdriver, 1 x 5.5 x L-type, B (ISO 2830); ADC part number TW-SD-VSL-4	
Tightening Torque [N•m (lb•in)]	0.8 to 1 (7 to 9)	

Fuji Duo Series TK-E Overload Relays

Operating characteristics

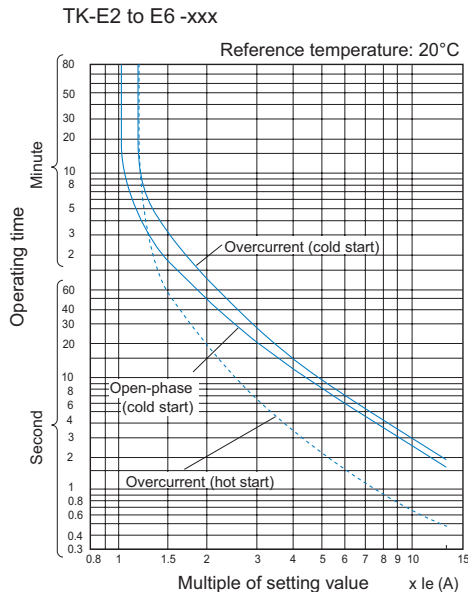
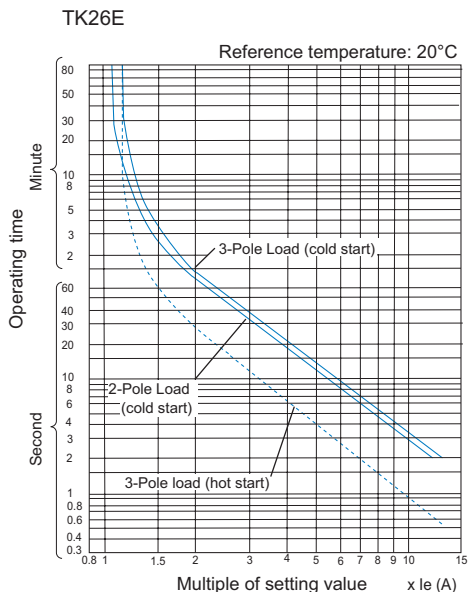

Wiring diagram

3-heater element

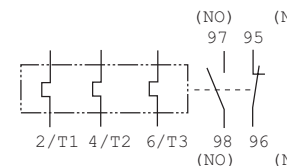

Optional accessories

Base units for separate mounting

Allows TK26E, E2, and E3 series thermal overload relays to be separately mounted to 35mm wide DIN rail, or screw mounted to panel.

Mounting Base Unit		
Part Number	Applicable Overload Relays	Price
TZ1H26E	TK26E-xxx	\$9.50
SZ-HDE	TK-E2-xxx	\$18.00
SZ-HEE	TK-E3-xxx	\$21.00

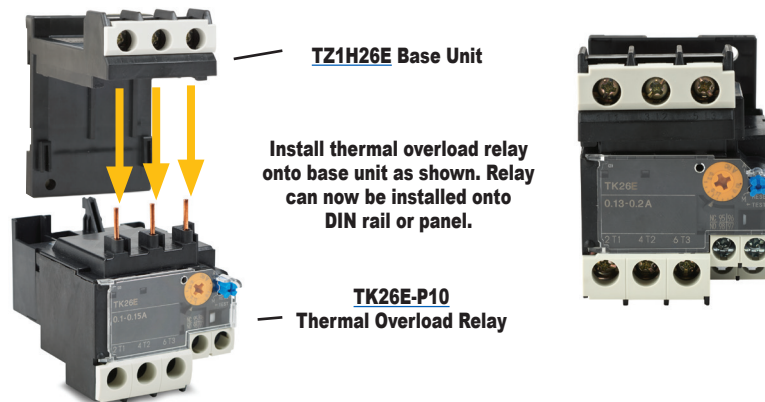

Dimensions mm [inches]

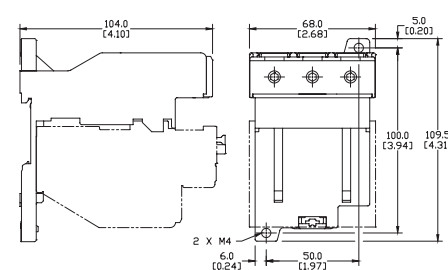
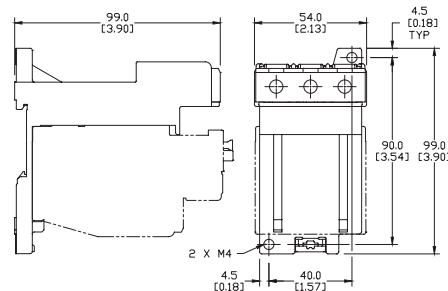
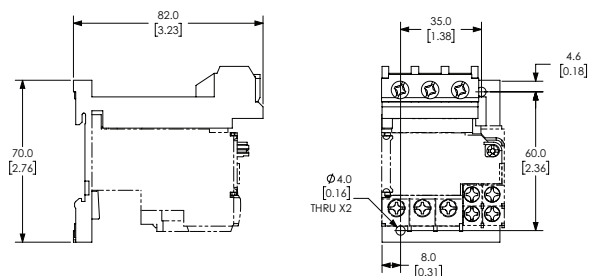
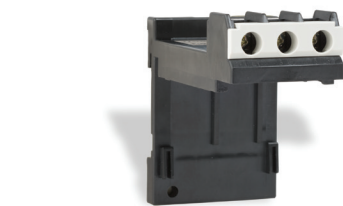

Please see our website www.AutomationDirect.com for complete engineering drawings.

Fuji Duo Series TK-E Overload Relays

Dimensions [inches (mm)]

Overload relays

TK26E-xxx

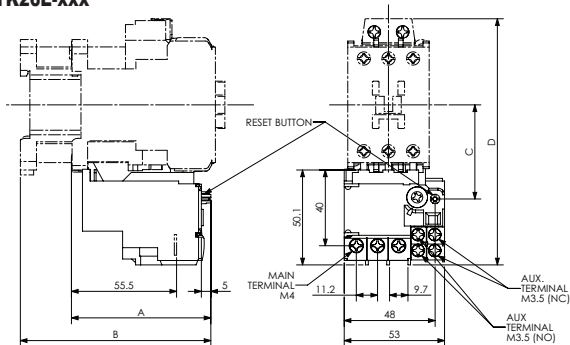

CONTACTOR	A	B	C	D
SC-E02 TO 05	2.89 (73.5)	-	1.99 (50.5)	5.12 (130)
SC-E02G TO 05G	-	3.96 (100.5)	1.99 (50.5)	5.12 (130)

Weight: 0.24 lb (0.11 kg)

TK-E2-xxx

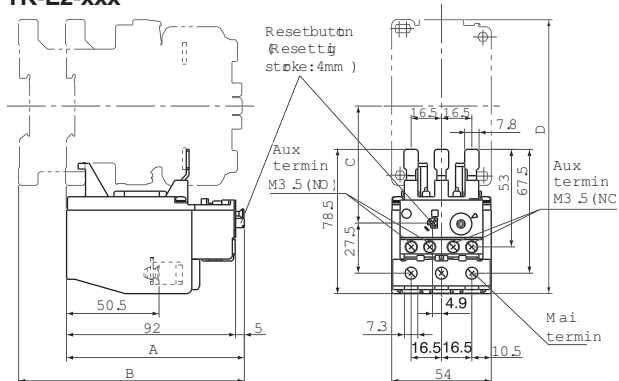

CONTACTOR	A	B	C	D
SC-E1 to E2S	3.82 (97)	-	2.5 (63.5)	5.87 (149)
SC-E1G to E2SG	-	4.82 (123)	2.5 (63.5)	5.87 (149)

Weight: 0.55 lb (0.25 kg)

TK-E3-xxx

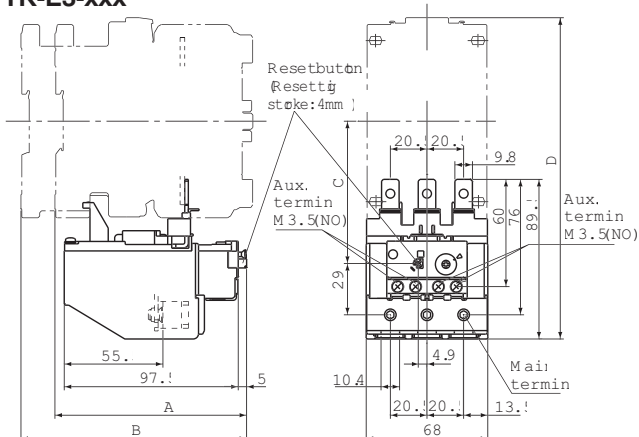

CONTACTOR	A	B	C	D
SC-E3, E4	4.23 (107.5)	-	3.13 (79.5)	7.09 (180)
SC-E3, E4G	-	4.98 (126.5)	3.13 (79.5)	7.09 (180)

Weight: 0.75 lb (0.34 kg)

TK-E5-xxx

On-contactor mounting only

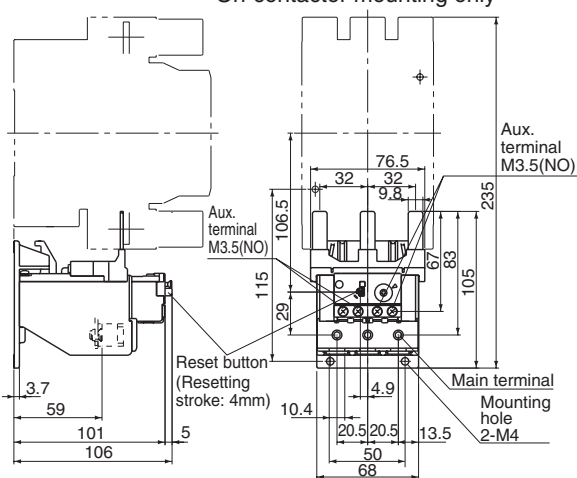

Weight: 0.82 lb (0.37 kg)

TK-E6-xxx

On-contactor mounting only

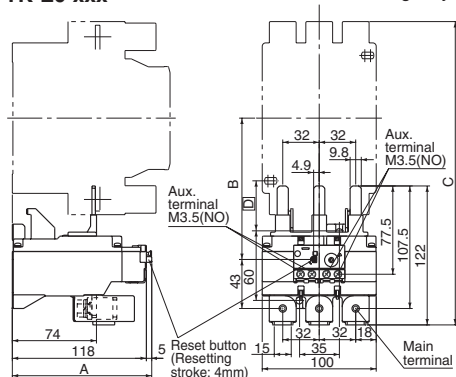

CONTACTOR	A	B	C	D
SC-E6	4.84 (123)	4.88 (124)	10.49 (266.5)	1.77 (45)
SC-E7	4.84 (123)	5.07 (129)	10.79 (274)	1.97 (50)

Weight: 1.57 lb (0.71kg)

Please see our website www.AutomationDirect.com for complete engineering drawings.