

Fuji Duo Series SC-E Contactors

Accessories

Optional accessories

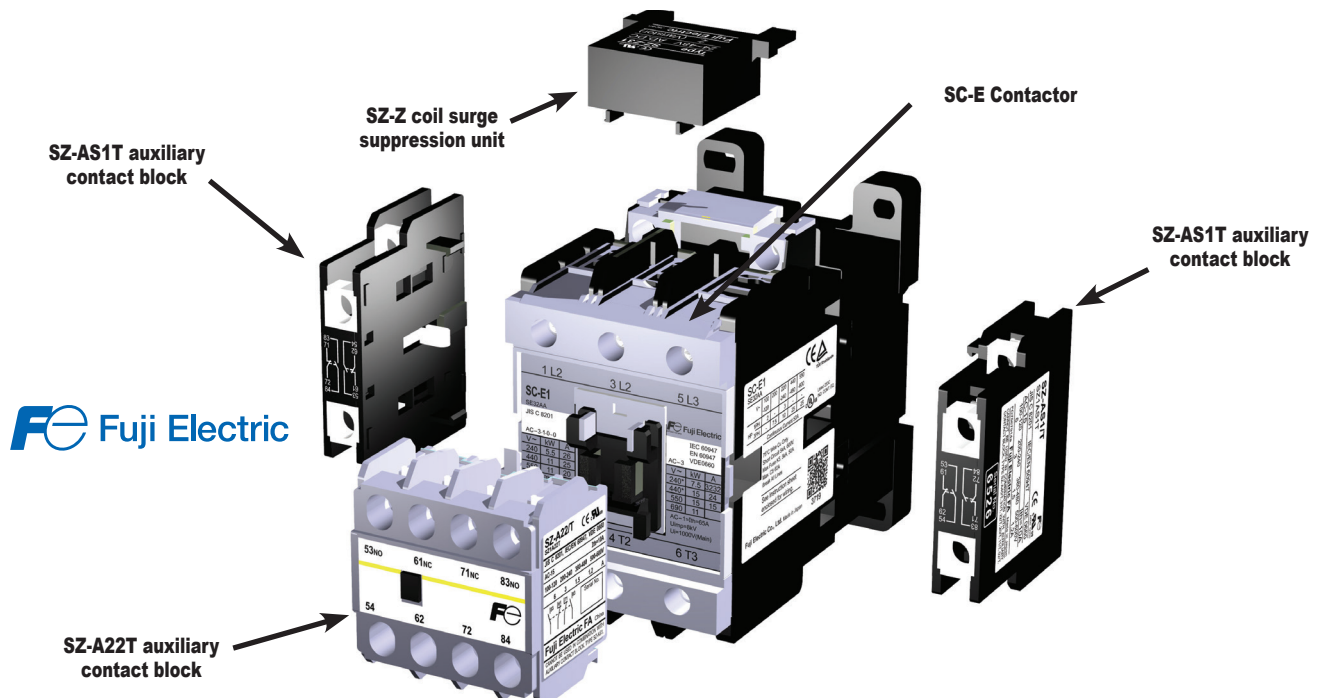

Auxiliary contact blocks with terminal covers

Maximum auxiliary contact blocks:

2 side mounted (1 per side) OR 1 front mounted. The front and side blocks cannot be mounted together on the same contactor.



SZ-A22T



SZ-A11T



SZ-AS1T



SZ-AS2T

Caution on use:

1. Front mounting auxiliary contact block and side mounting block cannot be attached to one contactor at the same time.
2. Only one front mounting block can be attached to one contactor.
3. Where interlock unit is already attached, side mounting auxiliary contact block can be attached on one side only.

Auxiliary Contact Blocks with Terminal Covers					
Part Number	Price	Applicable Contactor	Mounting	Number of Contacts	Contact Arrangement
<u>SZ-A22T</u>	\$19.50	SC-E02(G)-xxx to E4(G)-xxx	Front mounting	4	2NO + 2NC
<u>SZ-A20T</u>	\$12.50			2	2NO
<u>SZ-A11T</u>	\$12.50			2	1NO + 1NC
<u>SZ-AS1T</u>	\$19.50	SC-E02(G)-xxx to E4(G)-xxx	Side mounting	2	1NO + 1NC
<u>SZ-AS2T</u>	\$19.50			2	1NO + 1NC

Accessory Auxiliary Contact Ratings - UL and CSA				
NEMA ICS 5-2000 Ratings (note 1)				
AC Ratings			DC Ratings	
Designation	Making VA	Breaking VA	Designation	Making/Breaking VA
A600	7200	720	Q300	69

Note: For more information, refer to Control Circuit Contact Electrical Ratings

Accessory Auxiliary Contact Ratings - IEC and JIS continued on next page.

Fuji Duo Series SC-E Contactors Accessories

Accessory Auxiliary Contact Ratings - IEC and JIS							
Rated Thermal Current (A)	Making and Breaking Capacity at AC (A)		Rated operational current (A)				Minimum Operating Voltage and Current
			AC		DC		
			Voltage	AC-15 (Ind. load)	Voltage	DC-13 (Ind. load)	
10	120V	60	120V	6	24V	3	5VDC, 3mA
	220V	30	220V	3	48V	1.5	
	440V	15	440V	1.5	110V	0.55	
	600V	12	600V	1.2	220V	0.27	

Coil surge suppression units



SZ-Z1



SZ-Z37

Suppress surge voltage due to contactor ON-OFF operations; easily connect to contactor coil terminals.

Important: When driving 24VDC Fuji contactors with a PLC solid-state output, we recommend using diode terminal block part number DN-D10DR-A or ZL-TSD8-24. Please see application note AN-MISC-032 for additional information located on AutomationDirect.com/technotes.

Coil Surge Suppression Units					
Part Number	Price	Applicable Contactor		Operating Coil Voltage	Device
		AC Operated	DC Operated		
SZ-Z1	\$15.50	SC-E02-xxx to E05-xxx	SC-E02G-xxx to E05G-xxx	24-48V AC/DC	varistor
SZ-Z2	\$15.50			100-250V AC/DC	
SZ-Z31	\$20.50	SC-E1-xxx to -E4xxx	SC-E1G-xxx to E4G-xxx	24-48V AC/DC	
SZ-Z32	\$20.50			100-250V AC/DC	
SZ-Z4	\$17.00	SC-E02-xxx to E05-xxx	SC-E02G-xxx to E05G-xxx	24-48V AC/DC	capacitor / resistor
SZ-Z5	\$17.50			100-250V AC/DC	
SZ-Z34	\$20.50	SC-E1-xxx to E4-xxx	-	24-48V AC/DC	
SZ-Z35	\$20.50			100-250V AC/DC	
SZ-Z36	\$20.50	-	SC-E1G-xxx to E4G-xxx	24-48V AC/DC	
SZ-Z37	\$20.50			100-250V AC/DC	
SC-E02 to E05				380-440V AC/DC	
SC-E1 to E4				380-440V AC/DC	

Note: Super Magnet Coils on SC-E5, SC-E6, and SC-E7 contactors have internal surge suppression. See diagram below.

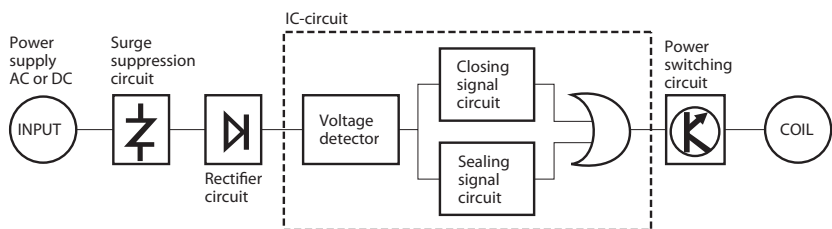

Fuji Duo Series SC-E Accessories

Connection kits for reversing SC-E contactors



SZ-ERW1A



SZ-ERW1B



SZ-ERW1D

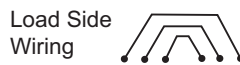

SZ-ERW2A



SZ-ERW2B

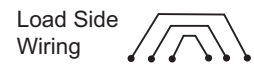

SZ-ERW2D



SZ-ERW3A



SZ-ERW3B



SZ-ERW3D



Connection Kits			
Part Number	Price	Description	Use with Contactors
SZ-ERW1A	\$7.75	Line side reversing connection kit.	SC-E02-xxx to SC-E05-xxx
SZ-ERW1B*	\$7.75	Load side reversing connection kit. For wiring load side when using contactors only or with a MMS device.	
SZ-ERW1D	\$7.75	Load side reversing connection kit. For wiring load side when using two contactors with a thermal overload relay.	
SZ-ERW2A	\$15.50	Line side reversing connection kit.	SC-E1-xxx to SC-E2S-xxx
SZ-ERW2B*	\$15.50	Load side reversing connection kit. For wiring load side when using contactors only or with a MMS device.	
SZ-ERW2D	\$15.50	Load side reversing connection kit. For wiring load side when using two contactors with a thermal overload relay.	
SZ-ERW3A	\$27.50	Line side reversing connection kit.	SC-E3-xxx to SC-E4-xxx
SZ-ERW3B*	\$27.50	Load side reversing connection kit. For wiring load side when using contactors only or with a MMS device.	
SZ-ERW3D	\$27.50	Load side reversing connection kit. For wiring load side when using two contactors with a thermal overload relay.	

* When using the SZ-ERWxB, a TK-E thermal overload relay must be separately mounted and wired using an SZ-HxE base. To assemble a TK-E overload directly to the contactor use a SZ-ERWxD load side connection kit.

Mechanical interlock unit



SZ-RM

Mechanical Interlock Unit			
Part Number	Price	Description	Use with Contactors
SZ-RM	\$19.50	Used when building a reversing starter. Prevents both contactors from being pulled in at once.	SC-E02-xxx to SC-E4-xxx

NOTE: Mechanical interlock unit cannot be used with SC-E5-xxx through E7-xxx contactors.

Parts for reversing Fuji SC-E contactors

- SC-E (Contactors - qty. 2)
- SZ-ERWxA (Line side connection kit - qty. 1)
- SZ-ERWxB* (Load side connection kit - qty. 1)
- SZ-RM (Mechanical interlock - qty. 1)
- SZ-AxxT (Auxiliary contact blocks - qty. 1)



Fuji Duo Series SC-E Contactors

Dimensions [mm]

Contactors

SC-E1G, E2G, E2SG-xxx

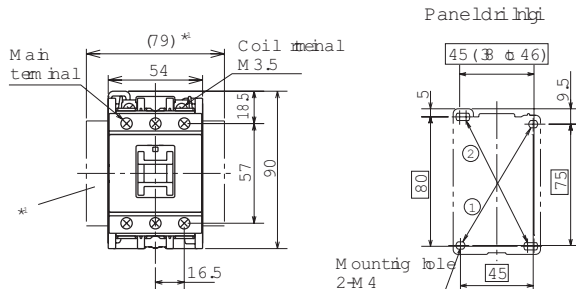
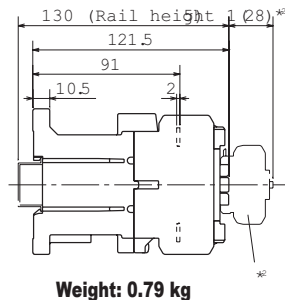

*1 Side mounting aux. contact block
*2 Front mounting aux. contact block

Use the mounting holes on diagonal line
① or ② on front contactor
①: 45 × 75 ②: 45 (ø 46) × 80

SC-E3G, E4G-xxx

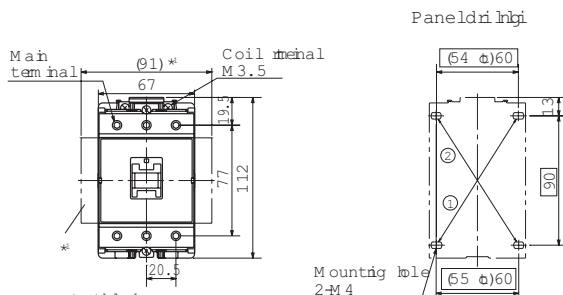
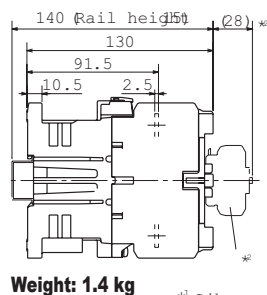

*1 Side mounting aux. contact block
*2 Front mounting aux. contact block

Use the mounting holes on diagonal line
① or ② on front contactor
①: 65 (ø 60) × 90 ②: 64 (ø 60) × 90

Dimensions [mm]

Auxiliary contact blocks - front mounting

SZ-A22T, A20T, A11T for SC-E02 (G)-xxx to E4 (G)-xxx

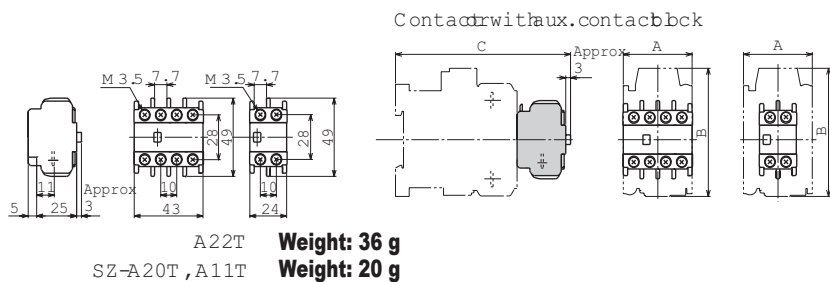

Wiring Diagrams

SZ-A22T, A20T, A11T

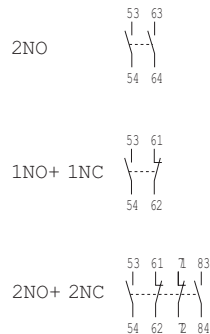

Type	A	B	C
SC-E02, E03, E04, E05-xxx	43	80	109
SC-E1, E2, E2S-xxx	54	90	124
SC-E3, E4-xxx	67	112	139
SC-E02G, E03G, E04G, E05(G)-xxx	43	80	136
SC-E1G, E2G, E2SG-xxx	54	90	149.5
SC-E3G, E4G-xxx	67	112	158

Fuji Duo Series SC-E Contactors

Dimensions (mm)

Auxiliary contact blocks - side mounting

SZ-AS1T for SC-E02(G)-xxx to E4(G)-xxx

Contactor with auxiliary contact block

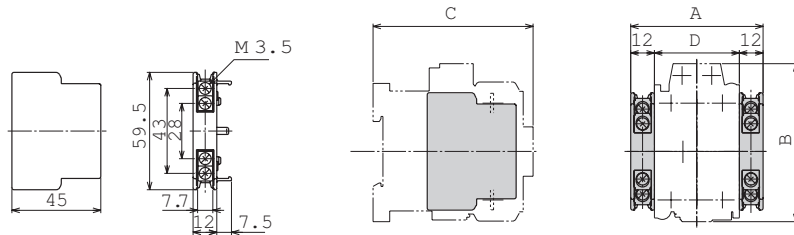

Weight: 28 g

Type	A	B	C	D
SC-E02, E03, E04, E05-xxx	67	80	81	43
SC-E1, E2, E2S-xxx	78	90	54	54
SC-E3, E4-xxx	91	112	67	67
SC-E02G, E03G, E04G, E05(G)-xxx	67	80	108	43
SC-E1G, E2G, E2SG-xxx	78	90	121.5	54
SC-E3G, E4G-xxx	91	112	130	67

Wiring Diagrams

1 N.O. + 1 N.C.

Mounted on right



Mounted on left side



SZ-AS2T for SC-E5 to E7-xxx

Contactor with aux. contact block

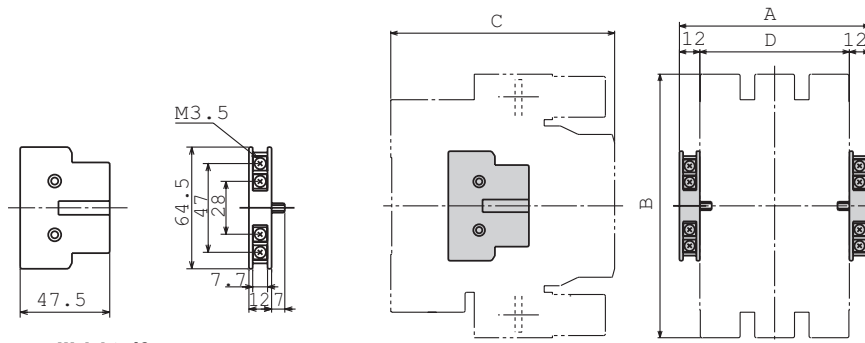

Weight: 40 g

Type	A	B	C	D
SC-E5-xxx	112	155	132	88
SC-E6-xxx	124	169	138	100
SC-E7-xxx	139	175	140	115

1 N.O. + 1 N.C.

Mounted on right



Mounted on left side



Fuji Duo Series SC-E Contactors

Dimensions (mm)

Coil surge suppression units

SZ-Z1, Z2, Z4, Z5

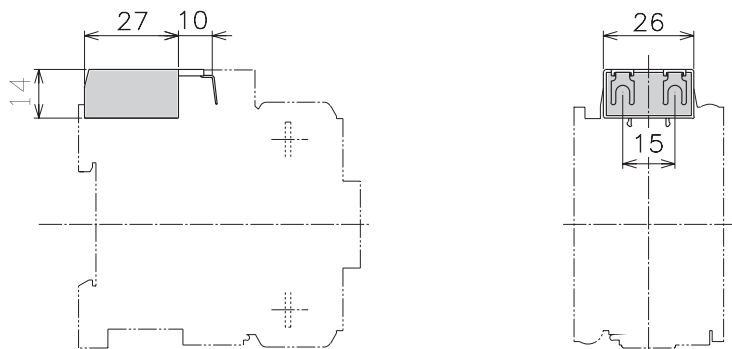

Weight: 14g

SZ-Z31, Z32, Z34, Z35, Z36, Z36, Z37

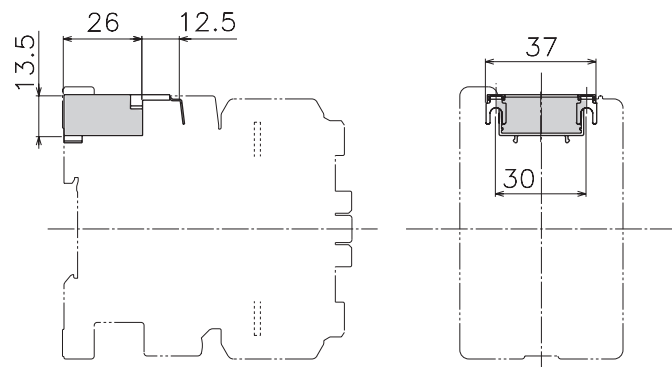

Weight: 15g

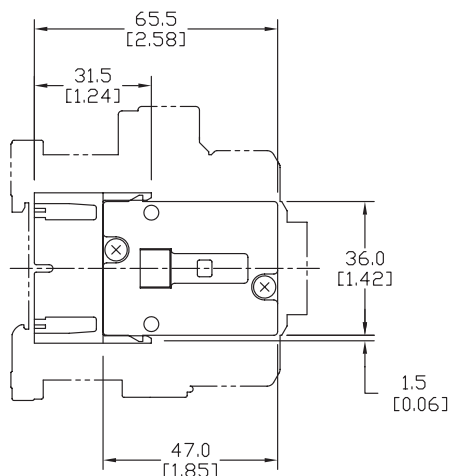

SZ-RM

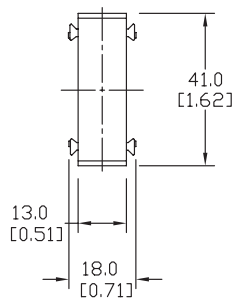
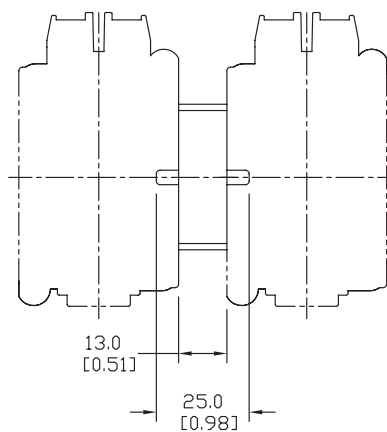

Wiring Diagrams

SC-E02 to E05-xxx + SZ-Z
(Built-in varistor)



SC-E02 to E05-xxx + SZ4,
(Built-in capacitor/resistor)

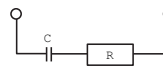

SC-E1 to E4-xxx + SZ1, Z1
(Built-in varistor)



SC-E1 to E4-xxx + SZ4, Z35
(Built-in capacitor/resistor)

SC-E1G to E4G-xxx + SZ6, Z
(Built-in capacitor/resistor)

