

Fuji 1/16 DIN Super Timers

Overview

The MS4S series super timers are 1/16 DIN style timing relays designed for process control, machine tool control, safety control and many other types of applications. The timers are plug-in 8-pin or 11-pin surface/DIN-rail mountable with up to four selectable modes of operation and four selectable timing ranges.



MS4SM Series

- Multi-mode timer with mode indication. On-delay (PO), flicker (FL), one-shot (OS), or signal off-delay (SF)
- 11-pin plug-in with start, reset and gate (interrupt) input signals and a DPDT contact output
- Timing range from 0.05 seconds to 60 hours
- Timer scale with selectable ranges of 0-6, 0-12, 0-30 and 0-60
- Timing units in selectable ranges of 0.1s, sec, min and hrs
- Power on LED indicator (green) flickers during timing operation, UP (red) LED is on when normally open contact is closed

MS4SA Series

- On-delay timer
- 8-pin plug-in with a DPDT contact output
- Timing range from 0.05 seconds to 60 hours
- Timer scale with selectable ranges of 0-6, 0-12, 0-30 and 0-60s

- Timing units in selectable ranges of 0.1s, sec, min and hrs
- Power on LED indicator (green) flickers during timing operation, UP (red) LED is on when normally open contact is closed

MS4SC Series

- On-delay timer
- 8-pin plug-in with a SPDT timed contact output and a SPDT instantaneous contact output
- Timing range from 0.05 seconds to 60 hours
- Timer scale with selectable ranges of 0-6, 0-12, 0-30 and 0-60
- Timing units in selectable ranges of 0.1s, sec, min and hrs
- Power on LED indicator (green) flickers during timing operation, UP (red) LED is on when normally open contact is closed

Fuji 1/16 DIN Super Timers Selection Chart

Part Number	Price	Description	Time Range
MS4SM-AP-ADC*	\$65.00	Fuji Electric multi-mode relay timer, 0.05 seconds to 60 hours selectable timing range, 100-240 VAC operating voltage, 5A contact rating, (1) DPDT timed relay output(s), socket mount, 11-pin. Requires Fuji Electric TP411X or TP411SBA timer socket.	0.05 seconds to 60 hours
MS4SA-AP-ADC	\$65.00	Fuji Electric on-delay relay timer, 0.05 seconds to 60 hours selectable timing range, 100-240 VAC operating voltage, 5A contact rating, (1) DPDT timed relay output(s), socket mount, 8-pin. Requires Fuji Electric TP48X or TP48SB timer socket.	0.05 seconds to 60 hours
MS4SC-AP-ADC*	\$65.00	Fuji Electric on-delay relay timer, 0.05 seconds to 60 hours selectable timing range, 100-240 VAC operating voltage, 5A contact rating, (1) SPDT timed relay and (1) SPDT instant relay output(s), socket mount, 8-pin. Requires Fuji Electric TP48X or TP48SB timer socket.	0.05 seconds to 60 hours
MS4SM-CE-ADC*	\$65.00	Fuji Electric multi-mode relay timer, 0.05 seconds to 60 hours selectable timing range, 24 VAC/VDC operating voltage, 5A contact rating, (1) DPDT timed relay output(s), socket mount, 11-pin. Requires Fuji Electric TP411X or TP411SBA timer socket.	0.05 seconds to 60 hours
MS4SA-CE-ADC*	\$65.00	Fuji Electric on-delay relay timer, 0.05 seconds to 60 hours selectable timing range, 24 VAC/VDC operating voltage, 5A contact rating, (1) DPDT timed relay output(s), socket mount, 8-pin. Requires Fuji Electric TP48X or TP48SB timer socket.	0.05 seconds to 60 hours
MS4SC-CE-ADC*	\$60.00	On-delay timer with selectable timing range from 0.05s to 60 hours. Input power is 24 VDC/AC. SPDT timed relay output and SPDT instantaneous relay output. 8-pin connection. UL, CSA, TUV approved.	0.05 seconds to 60 hours
TP411X	\$9.25	Fuji Electric timer socket, 35mm DIN rail mount. For use with MS4SM series timers.	N/A
TP411SBA	\$9.25	Fuji Electric timer socket, panel mount. For use with MS4SM series timers.	
TP48X	\$9.25	Fuji Electric timer socket, 35mm DIN rail mount. For use with MS4SA and MS4SC series timers.	
TP48SB	\$9.25	Fuji Electric timer socket, panel mount. For use with MS4SA and MS4SC series timers.	
PANEL-16	\$15.50	AutomationDirect mounting clips, package of 5. For use with 1/16 DIN timers and counters.	

* Socket mounts must be purchased separately

Dimensions

mm [inches]

(Timer and Socket Assembly)

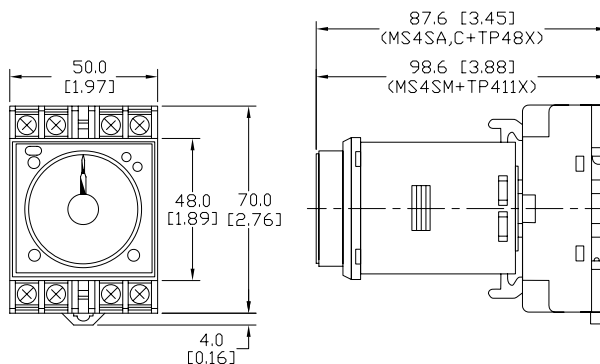

Control

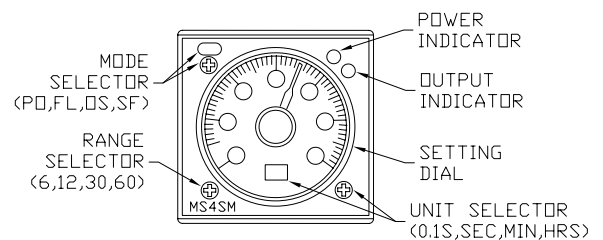

Fuji 1/16 DIN Super Timers



MS4SM-AP-ADC
MS4SM-CE-ADC



MS4SA-AP-ADC
MS4SA-CE-ADC



MS4SC-AP-ADC
MS4SC-CE-ADC



TP411X



TP411SBA*



TP48X



TP48SB*

Fuji 1/16 DIN Super Timers Specifications									
Approvals	UL file no.: E44592, CSA file no.: LR20479, TÜV license no: R9551800								
Repeat Accuracy	±0.3% at maximum setting time								
Reset Time	0.1 second or less								
Operating Voltage Range	<table border="0" style="width: 100%;"> <tr> <td style="width: 50%; text-align: center;">85-264 VAC 50/60Hz</td> <td style="width: 50%; text-align: center;">20.4-26.4 VDC/AC</td> </tr> <tr> <td style="text-align: center;">MS4SA-AP-ADC</td> <td style="text-align: center;">MS4SA-CE-ADC</td> </tr> <tr> <td style="text-align: center;">MS4SC-AP-ADC</td> <td style="text-align: center;">MS4SC-CE-ADC</td> </tr> <tr> <td style="text-align: center;">MS4SM-AP-ADC</td> <td style="text-align: center;">MS4SM-CE-ADC</td> </tr> </table>	85-264 VAC 50/60Hz	20.4-26.4 VDC/AC	MS4SA-AP-ADC	MS4SA-CE-ADC	MS4SC-AP-ADC	MS4SC-CE-ADC	MS4SM-AP-ADC	MS4SM-CE-ADC
85-264 VAC 50/60Hz	20.4-26.4 VDC/AC								
MS4SA-AP-ADC	MS4SA-CE-ADC								
MS4SC-AP-ADC	MS4SC-CE-ADC								
MS4SM-AP-ADC	MS4SM-CE-ADC								
Operating Temperature Range	-10 to +55°C [14 to 131°F] (no icing)								
Humidity	35 to 85% (no condensation)								
Contact Ratings	5A at 30VDC resistive load, 1A @ 30VDC inductive load, 5A @ 250VAC resistive load, 2.5 A @ 120VAC inductive load								
Power Consumption	Approx. 10VA for AC; 1W at 24VDC								
Insulation Resistance	100MΩ at 500VDC insulation tested								
Dielectric Strength	2000VAC 1 min. between current carrying part and non-current carrying part 2000VAC 1 min. between output contact and control circuit 1000VAC 1 min. between open contacts								
Vibration	Malfunction durability: 10 to 55Hz, 0.5mm double amplitude Mechanical durability: 10 to 55Hz, 0.75mm double amplitude								
Shock	Malfunction durability: 100m/s ² Mechanical durability: 500m/s ²								
Life Expectancy	Mechanical: 20 million operations (No load operation cycle: 1800/hr.) Electrical: 100,000 operations at 250 VAC 5 A resistive load (operation cycle: 1800/hr)								
Weight	Approx. 100g [3.527 oz]								

*When using panel mount sockets [TP411SBA](#) and [TP48SB](#), mounting clip [PANEL-16](#) is required and must be purchased separately.

Fuji 1/16 DIN Timers Timing and Wiring Diagrams

MS4SM

1. On-delay PO

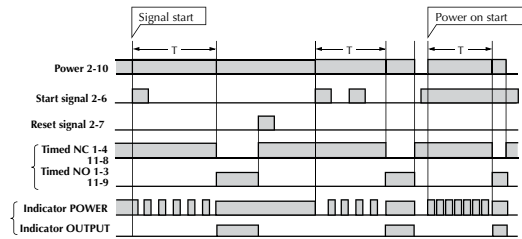

2. Flicker FL

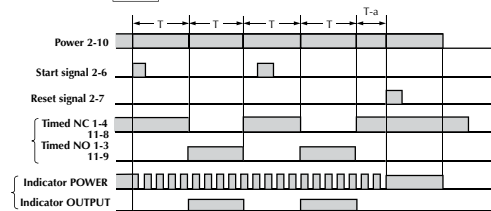

3. One-shot OS

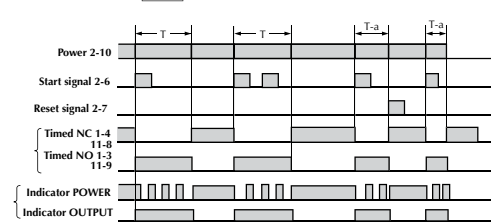

4. Signal off-delay SF

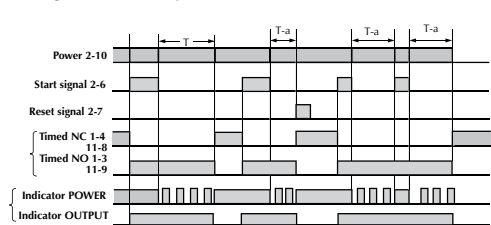

MS4SA On-delay

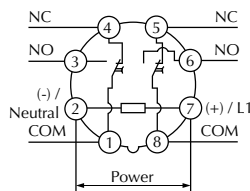
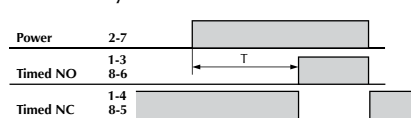

MS4SC On-delay

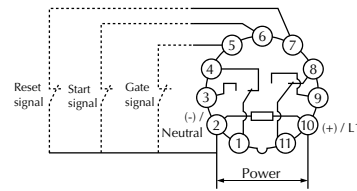
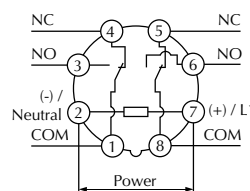
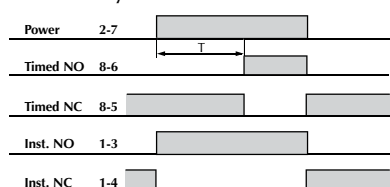

- With power off turn the mode selector until **PO** is displayed.
- When power is on, applying the start signal turns the timed N.O. (normally open) contact on after the set time has elapsed.
- When using a power-on start, pins 2 and 6 (start signal) must be jumpered together
- To make timer output a signal as soon as power is turned on, turn timer dial fully counter-clockwise.

- With power off, turn the mode selector until **FL** is displayed.
- When power is on, applying the start signal turns the timed contact on and off repeatedly at the set time intervals.
- When using a power-on start, pins 2 and 6 (start signal) must be jumpered together

- With power off, turn the mode selector until **OS** is displayed.
- When power is on, applying the start signal instantly turns the timed N.O. contact on and turns it off after the set time has elapsed.

- With power off, turn the mode selector until **SF** is displayed.
- When power is on, applying the start signal instantly turns the timed N.O. contact on. Removing the start signal turns the contact off after the set time has elapsed.

Notes:

1. T = set time. t = time period within set time.
2. The gate signal is used to interrupt the timing operation.

- When power is applied, the timed N.O. contacts make after the set time has elapsed.
- When power is removed, the contacts reset.
- To make timer output a signal as soon as power is turned on, turn timer dial fully counter-clockwise.

- Timed contact
When power is applied, the N.O. contact makes after the set time has elapsed. When power is removed, the contacts reset.
- Instantaneous contact
When power is applied, the N.O. contact makes instantly. When power is removed, the contacts reset.
- To make timer output a signal as soon as power is turned on, turn timer dial fully counter-clockwise.

Fuji 1/16 DIN Super Timers Dimensions

Dimensions

mm [inches]

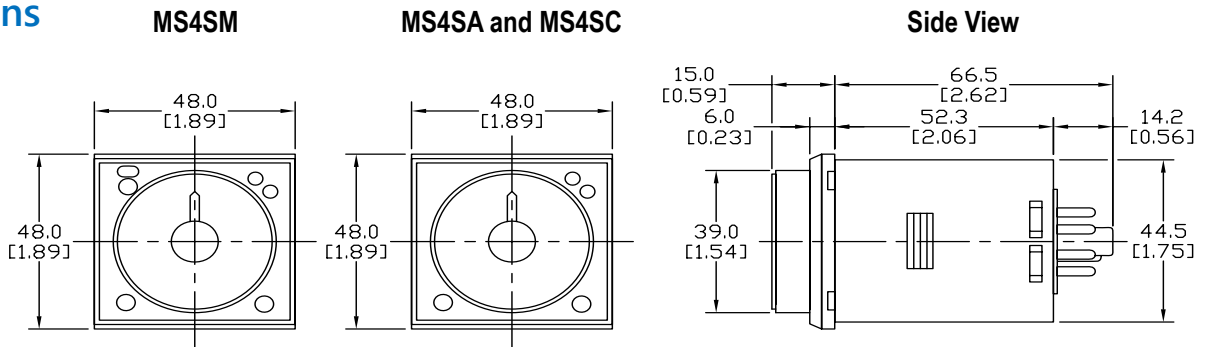

Socket for MS4SA, MS4SC (8-pin)
TP48X

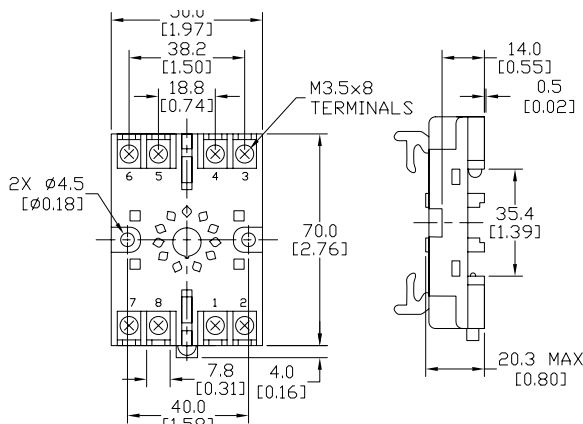

Socket for MS4SA, MS4SC (8-pin)
TP48SB

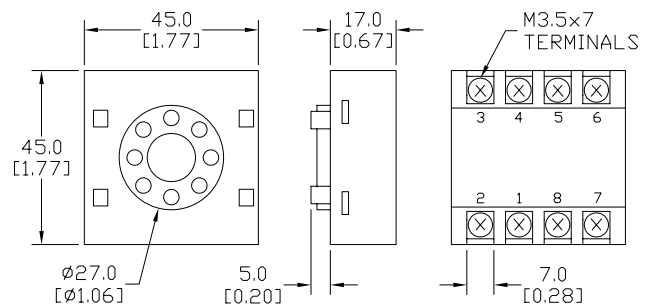

Socket for MS4SM (11-pin)
TP411X

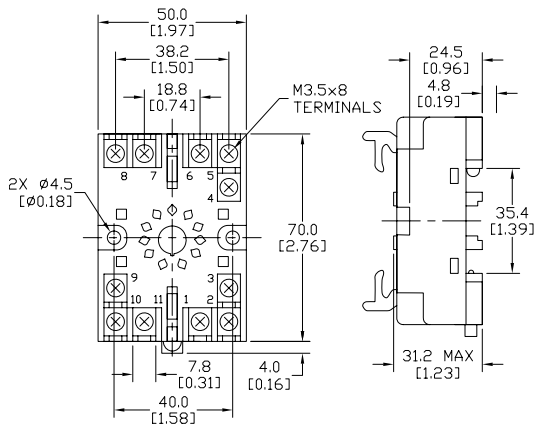

Socket for MS4SM (11-pin)
TP411SBA

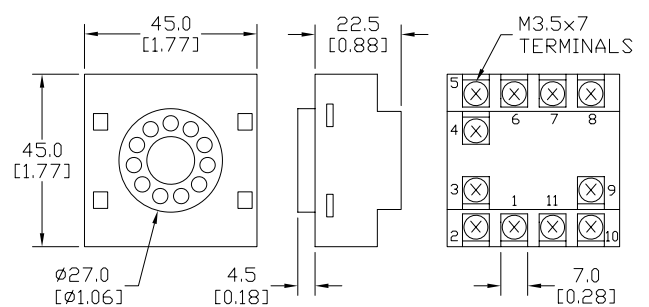

Cutout for panel mounting TP48SB and TP411SBA sockets using PANEL-16 mounting clips

