



Switch-Tek™ LZ12 Vibration Fork Level Switch

Part No. [LZ12-1405](#)

Switch-Tek LZ12 Technical Specifications

Model	LZ12-1405
Price	\$370.00
Weight (lb)	0.7
Insertion Length	2.3 in [57mm]
Orientation	Universal
Accuracy	±1mm [0.04 in] in water
Repeatability	±0.5 mm [0.02 in] in water
Supply Voltage	12-30 VDC
Consumption	25mA maximum
Contact Type	(1) SPST relay
Contact Rating	60VA, 1A maximum (125VAC max)
Contact Output	Selectable NO / NC
Maint. Alarm	NPN transistor, 10mA maximum
Process Temp.	-40°F to 176°F [-40°C to 80°C]
Pressure	150psi [10bar] @ 25°C, derated @ 1.667 psi [0.113 bar] per °C above 25°C
Sensor Rating	NEMA 6 (IP68)
Sensor Material	Ryton® (glass filled)
Cable Grommet Material	Viton®
Cable Jacket Material	PP (polypropylene)
Cable Type	5-conductor, #24AWG, shielded
Cable Length	10ft (3m)
Process Mount	3/4" NPT
Classification	General purpose
Compliance*	CE (EN61326, EN61010-1)

* To obtain the most current agency approval information, see the Agency Approval Checklist section on the specific part number's web page at www.AutomationDirect.com

Overview

The general purpose vibration point level switch provides reliable liquid level detection of dirty liquids such as those with light to medium coating, scaling or foaming characteristics with a 1A relay output. Media examples include wastewater, diluted caustic soda and light weight oil. For optimum performance, the liquid level switch automatically adjusts for coating build up and, if necessary, outputs a proactive maintenance alarm to request cleaning. The submersible Ryton® liquid level sensor is universally mounted through the tank wall or inside the tank as a high level or low level alarm.

Features

- Automatic coating adjustment optimizes sensor performance
- Submersible Ryton® sensor with polypropylene (PP) cable for corrosive liquids
- Coating alarm proactively alerts user when cleaning is required
- 60VA relay selectable NO or NC via power supply wiring polarity
- Compatible with Switch-Pak installation fittings
- Ideal for coating/scaling liquids
- Mounts through side wall or top wall of tank
- 2-year warranty



Dimensions

inches [mm]

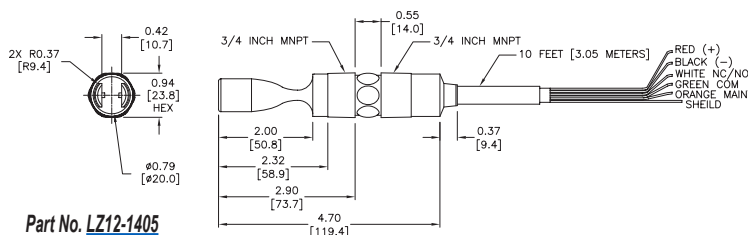
Part No. [LZ12-1405](#)

See our website www.AutomationDirect.com for complete Engineering drawings.

Compatible Products

Switch-Pro™ Remote Level Controllers



LCXX

Switch-Pro™ Junction Box and Strobe



LC06-1001



LC06-1001 with LC09-1004 and LM90-1001

Switch-Pak™ Installation Fittings



LM45-1001-12



LM45-7001-0000

See the Switch-Pro® LCXX and Accessories pages at the end of the section for further details and pricing.



Switch-Pro™ Remote Level Controllers

Part No. [LC40-1001](#)Part No. [LC41-1001](#)Part No. [LC42-1001](#)

Overview

CSA approved, the Switch-Pro general purpose level controllers are offered in three configurations for alarms, pump and valve control. The LC40 accepts one level sensor input and provides one 10A relay for high level or low level alarm. The LC41 accepts two level sensor inputs and provides one latching 10A relay for automatic fill or empty control. The LC42 accepts three level sensor inputs with one latching 10A relay output for automatic fill or empty control, and a second non-latching 10A relay for high level or low level alarm.

Features

- Fail-safe relay control of pumps or valves with 0-60 second delay
- Easy setup with LED indicators for sensor, power and relay status
- 35mm DIN rail mount or panel mount polypropylene (PP) enclosure with removable terminal strips
- Invert switch changes relay state from NO to NC without rewiring
- Mounts easily in control panel
- Connects to any Flowline level switch
- Interfaces directly with any horn, buzzer, valve, etc...
- Use LC41, LC42 version for automatic fill/empty operations
- 2-year warranty



Switch-Pro LC Series Technical Specifications

Model	LC40-1001	LC41-1001	LC42-1001
Price	\$275.00	\$325.00	\$385.00
Weight (lb)	1.9	1.9	1.9
Supply Voltage	120VAC @ 50-60 Hz (can be field configured for 240VAC)		
Consumption	5W maximum		
Sensor Inputs	(1) two wire level switch	(2) two wire level switches	(3) two wire level switches
Sensor Supply	13.5 VDC @ 27mA		
LED Indication	Sensor (green), power (green) & relay (red)		
Contact Type	(1) SPDT relay (non-latching)	(1) SPDT relay (latching)	(2) SPDT relays, (one non-latching, one latching)
Contact Rating	250VAC @ 10A		
Contact Output	Selectable NO / NC		
Contact Latch	N/A	Selectable ON / OFF	Selectable ON / OFF
Contact Delay	0-60 seconds		
Ambient Temperature	-40°F to 158°F [-40°C to 70°C]		
Enclosure Mounting	35mm DIN rail or thru-hole panel mount		
Enclosure Material	PP (polypropylene), UL94VO		
Classification	General purpose		
Compliance*	CSA LR 79326		

* To obtain the most current agency approval information, see the Agency Approval Checklist section on the specific part number's web page at www.AutomationDirect.com



Switch-Pro™ Remote Level Controllers

Wiring

LC40 series: 1 sensor input, 1 relay output.

Typical Application:

High level or low level alarm



LC41 series: 2 sensor inputs, 1 relay output. The relay included is a latching relay.

Typical Application:

Automatic fill or empty



LC42 series: 3 sensor input, 2 relay outputs. One relay is latching and the other is a single input relay.

Typical Application:

Automatic fill or empty with high level or low level alarm

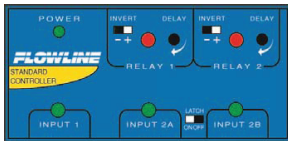

Low Level Alarm Output Wiring Example (One level sensor input required):

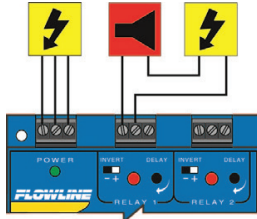

Automatic Fill Output Wiring Example (Two level sensor inputs required):

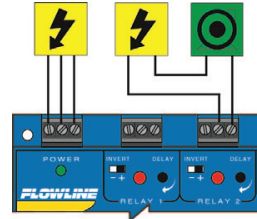

High Level Alarm Output Wiring Example (One level sensor input required):

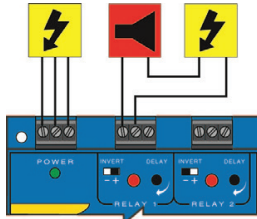

Automatic Empty Output Wiring Example (Two level sensor inputs required):

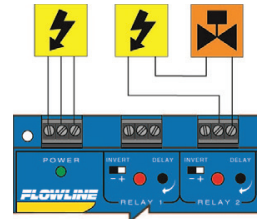

Level Sensor Input Wiring Example:

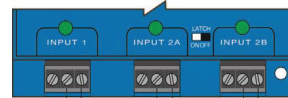

Symbol Key:



Black
Red
LZ12
LU10
LP15
LV10*

LV10 series can be wired using the White and Black wires for NO operations or the Red and Black wires for NC operations.

Dimensions

inches [mm]

MODEL LC42

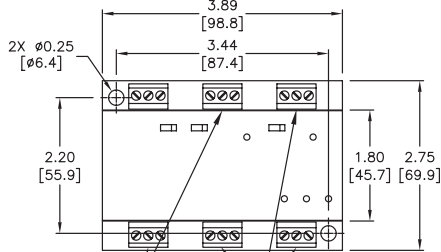

TERMINAL BLOCKS N/A FOR LC41 MODELS

TERMINAL BLOCKS N/A FOR LC40 MODELS

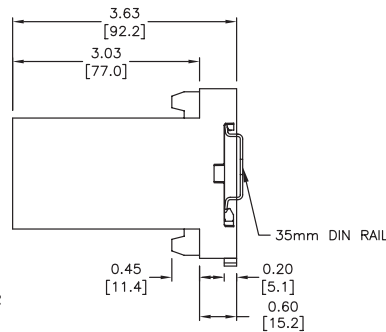

See our website www.AutomationDirect.com for complete Engineering drawings.

Compatible Products

ProSense Float Level Switches







Switch-Tek™ Level Switch Sensors





Level Switch Accessories

Level Sensor Accessories					
Part No.	Item Photo	Description	Quantity	Weight (lb)	Price
<u>LM45-1001-12</u>		Flowline Switch-Pak level sensor extension installation fitting, polypropylene (PP) construction, 12 inch insertion length, 2 inch NPT male process connection, 3/4 inch NPT female sensor threads, 3/4 inch NPT male electrical junction box threads	1	1.1	\$72.00
<u>LM45-7001-0000</u>		Flowline Switch-Pak level sensor extension installation fitting kit, polyvinyl chloride (PVC) construction, includes (1) fitting with 2 inch NPT male process connection, 3/4 inch NPT male electrical junction box threads and 3/4 inch PVC pipe socket; (1) fitting with 3/4 inch NPT female sensor threads and 3/4 inch female PVC pipe socket. Purchase 3/4 inch schedule 40 PVC pipe separately, cut to desired length and solvent weld to fittings in this kit.	1	0.7	\$52.00
<u>LC06-1001</u>		Flowline Switch-Pro compact electrical junction box, polypropylene (PP) construction, screw cover with O-ring gasket, NEMA 4X rated, 3/4 inch NPT female mounting threads with 300 degree swivel base, 1/2 inch NPT female conduit entrance, removable 6-pole terminal strip	1	0.7	\$85.00
<u>LM90-1001</u>		Cable gland, 1/2 inch NPT male thread, Buna N sealing gland accommodates a cable diameter range of 0.180 to 0.400 inches (4.6 to 10.2 mm), nylon housing, IP68 protection level	1	0.4	\$10.00

Accessory Field Assembly Example



Order the following parts for field assembly: (1)

[LC06-1001](#) - Junction box

(1) [LM90-1001](#) - Cable gland

(1) LU10 Series ultrasonic level switch



Level Switch Accessory Drawings

Dimensions

inches [mm]

LM45-1001-12

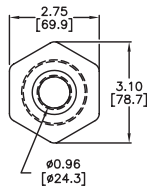

LM45-7001-0000

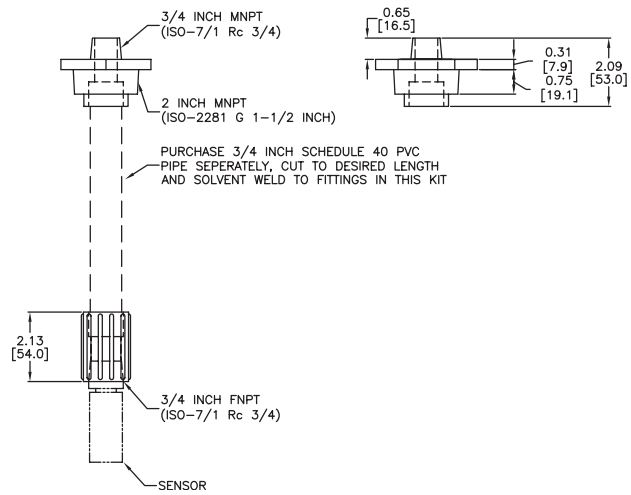
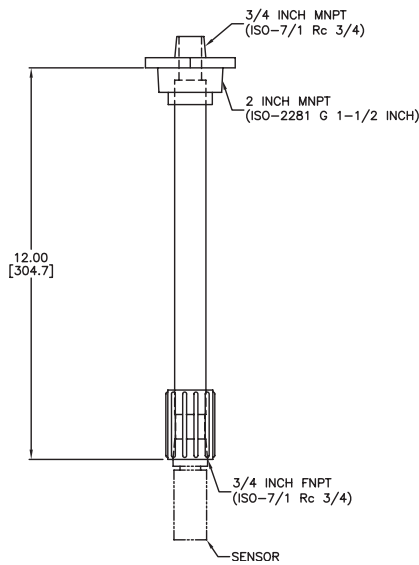
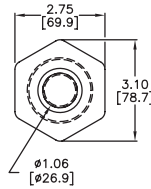

LC06-1001

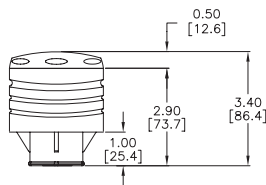
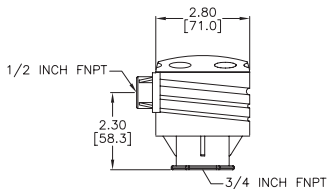
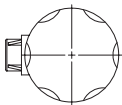

See our website www.AutomationDirect.com for complete Engineering drawings.



Level Switch Accessory Drawings

Dimensions

inches [mm]

LM90-1001

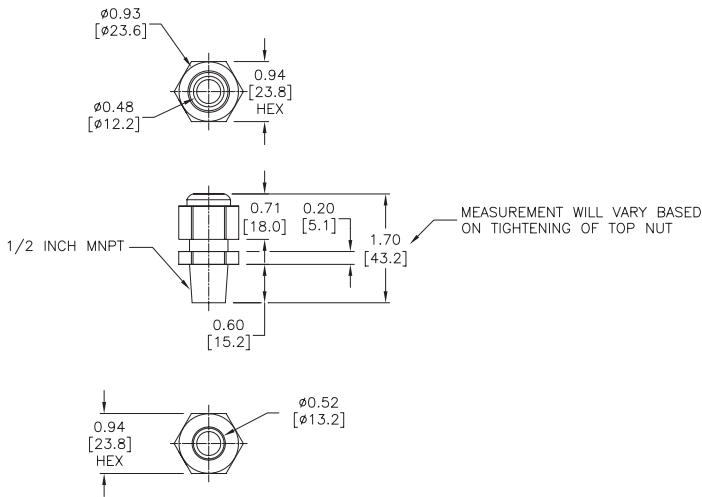

See our website www.AutomationDirect.com for complete Engineering drawings.