

FATH® T-Slotted Rail Accessories

Monitor Mounts



10 Series Monitor Mounts

- Fits monitors with VESA mounting standard
- Durable steel construction
- Powder coat finish
- Mounting hardware included for several mounting locations

Fits Slot Size 6

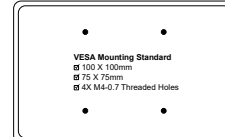
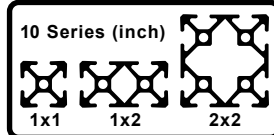

| Part Number | Part Image | Price | Description | Load Rating kg [lb] | Pack Quantity | Installation Instructions Link | Drawing Link |
|------------------------|------------|---------|----------------------|------------------------|---------------|-----------------------------------|---------------------|
| 162893 | | \$42.00 | Swivel Monitor Mount | 15 [33.1] | 1 | PDF | PDF |
| 162894 | | \$50.00 | | | | PDF | PDF |
| 162895 | | \$58.00 | | | | PDF | PDF |



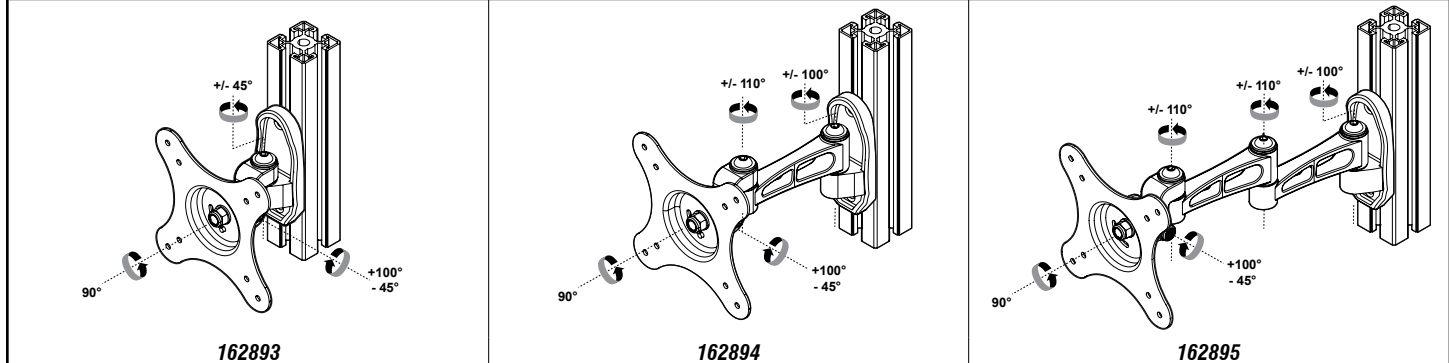





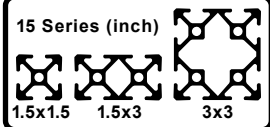

Monitor Mounts Adjustments



FATH® T-Slotted Rail Accessories

Monitor Mounts



| 15 Series Monitor Mounts | | | | | | | |
|--|---|--|---|---|---------------------|-----------------------------------|---------------------|
| <ul style="list-style-type: none"> Fits monitors with VESA mounting standard Durable steel construction Mounting hardware included for several mounting locations | | Fits  Slot Size 8 |  |  | | | |
| Part Number | Part Image | Price | Description | Load Rating kg [lb] | Pack Quantity | Installation Instructions Link | Drawing Link |
| 162893 |  | \$42.00 | Swivel Monitor Mount | 15 [33.1] | 1 | PDF | PDF |
| 162894 |  | \$50.00 | | | | PDF | PDF |
| 162895 |  | \$58.00 | | | | PDF | PDF |
| 162896 |  | \$92.00 | Monitor Mounting Joint | | | PDF | PDF |
| 162897 |  | \$92.00 | Monitor Holder | | | PDF | PDF |
| 162899 |  | \$325.00 | 4-Axis Mounting Support | 10 [22.0] | | PDF | PDF |
| 162900 |  | \$375.00 | 5-Axis Mounting Support | | | PDF | PDF |
| 162901 |  | \$600.00 | 4-Axis Workstation | 8 [17.6] | PDF | PDF | |

FATH® T-Slotted Rail Accessories



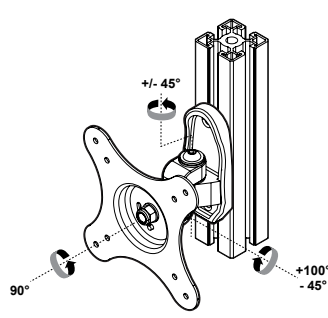
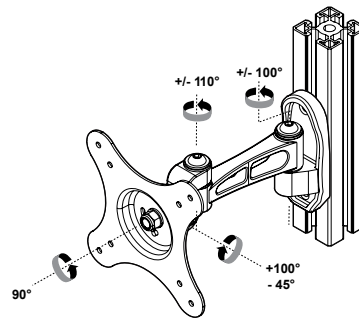
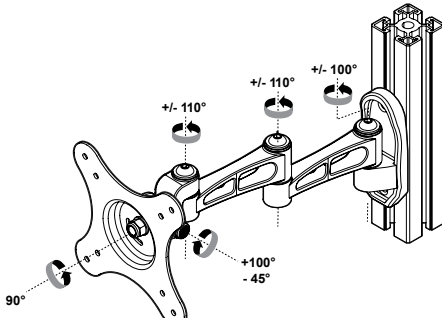
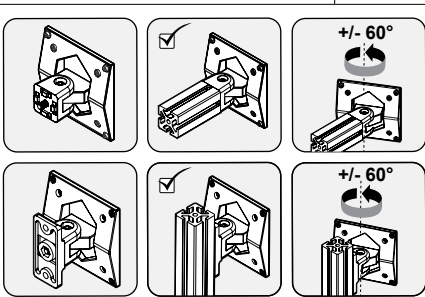
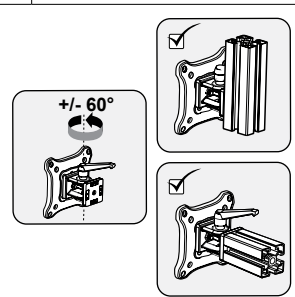
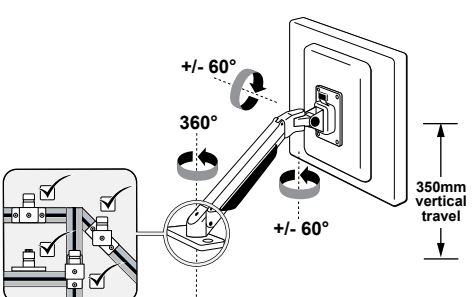
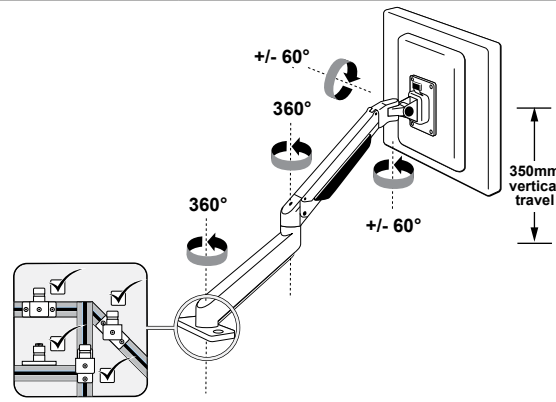
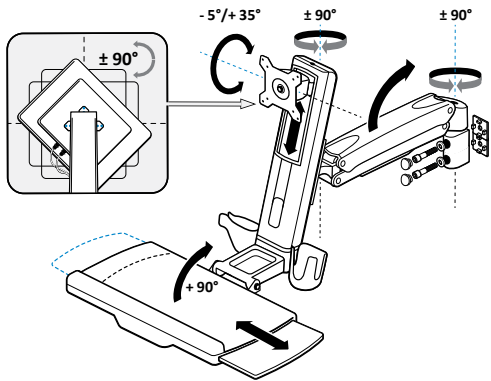

Monitor Mounts - Continued

| Monitor Mounts Adjustments | | |
|---|--|--|
|  <p>162893</p> |  <p>162894</p> |  <p>162895</p> |
|  <p>162896</p> | |  <p>162897</p> |
|  <p>162899</p> | |  <p>162900</p> |
|  <p>162901</p> | | |

FATH® T-Slotted Rail Accessories

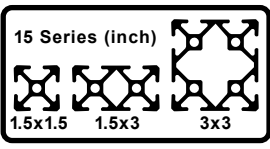
Workstation Components



| 15 Series Workstation Components | | | | | | | |
|--|--|---|--|------------------------|------------------|----------------|---------------------|
| Fits  | |  | | | | | |
| Part Number | Part Image | Price | Description | Load Rating kg [lb] | Pack Quantity | Material | Drawing Link |
| 162902 |  | \$185.00 | Keyboard Holder (requires mounting solution, designer's choice) | n/a | 1 | Aluminum/nylon | PDF |
| 162906 |  | \$8.00 | Magnetic Holder | | | Nylon/steel | PDF |
| 162964 |  | \$9.00 | Grab Tray | | | Nylon | PDF |
| 162965 |  | \$2.00 | Label Clip | | | PVC | PDF |

Workstation Components Installation

Keyboard Holder (mounting example)

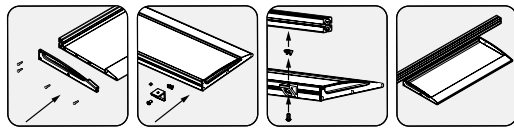

Magnetic Holder

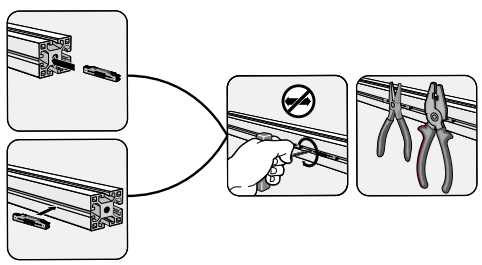

Grab Tray

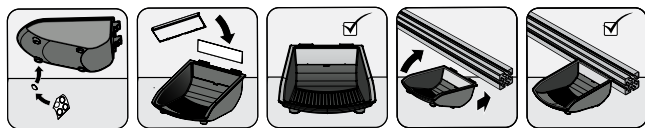

Label Clip

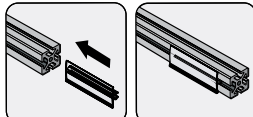

FATH® T-Slotted Rail Accessories

Monitor Mounts



30 Series Monitor Mounts

- Fits monitors with VESA mounting standard
- Durable steel construction
- Powder coat finish
- Mounting hardware included for several mounting locations

Fits Slot Size 8

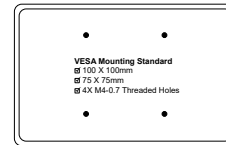
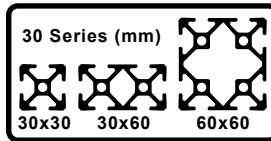

| Part Number | Part Image | Price | Description | Load Rating kg [lb] | Pack Quantity | Installation Instructions Link | Drawing Link |
|------------------------|------------|---------|----------------------|------------------------|---------------|-----------------------------------|---------------------|
| 162893 | | \$42.00 | Swivel Monitor Mount | 15 [33.1] | 1 | PDF | PDF |
| 162894 | | \$50.00 | | | | PDF | PDF |
| 162895 | | \$58.00 | | | | PDF | PDF |



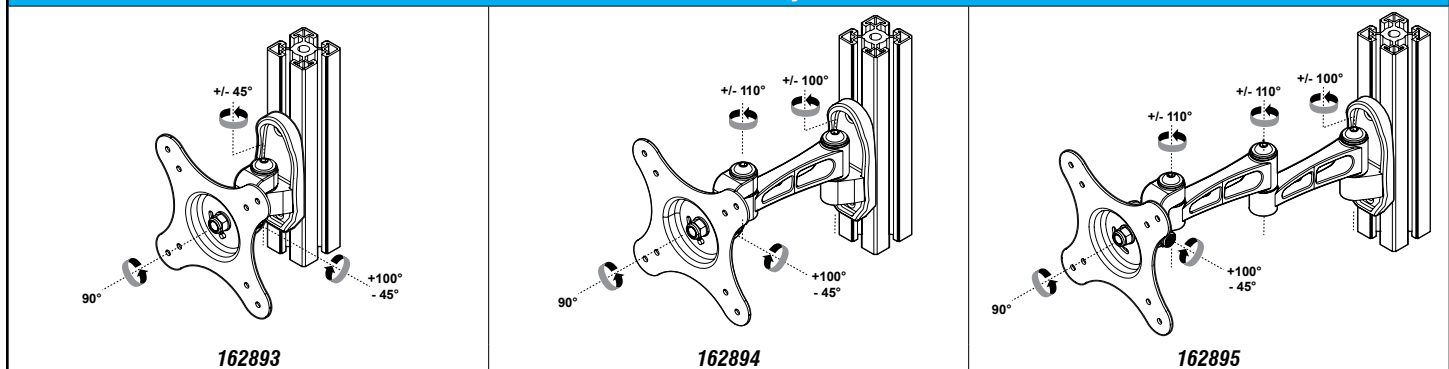

Monitor Mounts Adjustments

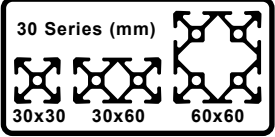

FATH® T-Slotted Rail Accessories

Workstation Components



| 30 Series Workstation Components | | | | | | | |
|----------------------------------|---|--|-----------------|---|---------------|----------------|---------------------|
| | | Fits  Slot Size 8 | |  | | | |
| Part Number | Part Image | Price | Description | Load Rating kg [lb] | Pack Quantity | Material | Drawing Link |
| 162902 |  | \$185.00 | Keyboard Holder | n/a | 1 | Aluminum/nylon | PDF |
| 162964 |  | \$9.00 | Grab Tray | | | Nylon | PDF |
| 162965 |  | \$2.00 | Label Clip | | | PVC | PDF |

Workstation Components Installation

Keyboard Holder (mounting example)

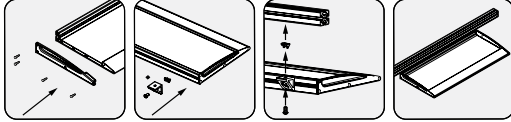

Grab Tray





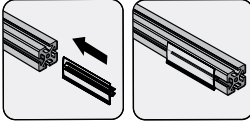





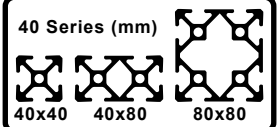

Label Clip



FATH® T-Slotted Rail Accessories

Monitor Mounts



| 40 Series Monitor Mounts | | | | | | | |
|--|---|--|---|---|---------------------|-----------------------------------|---------------------|
| <ul style="list-style-type: none"> Fits monitors with VESA mounting standard Durable steel construction Mounting hardware included for several mounting locations | | Fits  Slot Size 8 |  |  | | | |
| Part Number | Part Image | Price | Description | Load Rating kg [lb] | Pack Quantity | Installation Instructions Link | Drawing Link |
| 162893 |  | \$42.00 | Swivel Monitor Mount | 15 [33.1] | 1 | PDF | PDF |
| 162894 |  | \$50.00 | | | | PDF | PDF |
| 162895 |  | \$58.00 | | | | PDF | PDF |
| 162896 |  | \$92.00 | Monitor Mounting Joint | | | PDF | PDF |
| 162897 |  | \$92.00 | Monitor Holder | | | PDF | PDF |
| 162899 |  | \$325.00 | 4-Axis Mounting Support | 10 [22.0] | | PDF | PDF |
| 162900 |  | \$375.00 | 5-Axis Mounting Support | | | PDF | PDF |
| 162901 |  | \$600.00 | 4-Axis Workstation | 8 [17.6] | PDF | PDF | |

FATH® T-Slotted Rail Accessories

Monitor Mounts - Continued

Monitor Mounts Adjustments

162893 **162894** **162895**

162896 **162897**

162899 **162900**







162901

Detailed description of the diagram grid:
 - **162893**: Side view of a monitor mount with adjustment ranges: $\pm 45^\circ$, 90° , $+100^\circ$, and -45° .
 - **162894**: Side view of a monitor mount with adjustment ranges: $\pm 110^\circ$, $\pm 100^\circ$, 90° , $+100^\circ$, and -45° .
 - **162895**: Side view of a monitor mount with adjustment ranges: $\pm 110^\circ$, $\pm 100^\circ$, 90° , $+100^\circ$, and -45° .
 - **162896**: Six small diagrams showing top-down adjustments with a range of $\pm 60^\circ$.
 - **162897**: Three small diagrams showing top-down adjustments with a range of $\pm 60^\circ$.
 - **162899**: Front view of a monitor mount with rotation ranges of $\pm 60^\circ$ and 360° , and a vertical travel range of 350mm.
 - **162900**: Front view of a monitor mount with rotation ranges of $\pm 60^\circ$ and 360° , and a vertical travel range of 350mm.
 - **162901**: Large front view of a monitor mount with multiple adjustment axes: $\pm 90^\circ$, $-5^\circ/+35^\circ$, $\pm 90^\circ$, $\pm 90^\circ$, and $+90^\circ$.

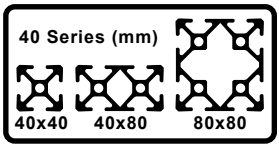
FATH® T-Slotted Rail Accessories

Workstation Components



| 40 Series Workstation Components | | | | | | | |
|----------------------------------|---|--|--|---|------------------|----------------|---------------------|
| | | Fits  Slot Size 8 | |  | | | |
| Part Number | Part Image | Price | Description | Load Rating kg [lb] | Pack Quantity | Material | Drawing Link |
| 162902 |  | \$185.00 | Keyboard Holder (requires mounting solution, designer's choice) | n/a | 1 | Aluminum/nylon | PDF |
| 162906 |  | \$8.00 | Magnetic Holder | | | Nylon/steel | PDF |
| 162909 |  | \$5.25 | Top Angle Clamp | | | Nylon/steel | PDF |
| 162964 |  | \$9.00 | Grab Tray | | | Nylon | PDF |
| 162965 |  | \$2.00 | Label Clip | | | PVC | PDF |

Workstation Components Installation

Keyboard Holder (mounting example)

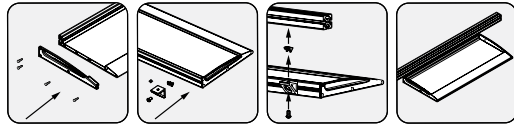

Magnetic Holder

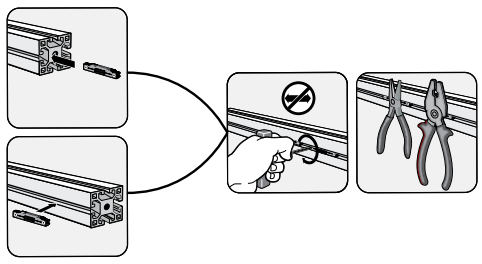

Grab Tray

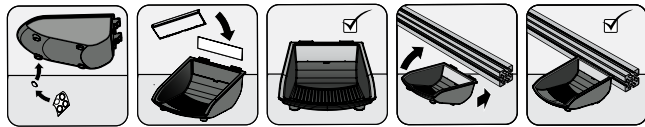



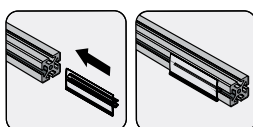





Label Clip

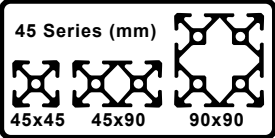
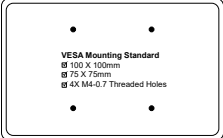

FATH® T-Slotted Rail Accessories

Monitor Mounts



| 45 Series Monitor Mounts | | | | | | | |
|--|---|---|---|---|---------------------|-----------------------------------|---------------------|
| <ul style="list-style-type: none"> Fits monitors with VESA mounting standard Durable steel construction Powder coat finish Mounting hardware included for several mounting locations | | Fits  Slot Size 10 |  |  | | | |
| Part Number | Part Image | Price | Description | Load Rating kg [lb] | Pack Quantity | Installation Instructions Link | Drawing Link |
| 162893 |  | \$42.00 | Swivel Monitor Mount | 15 [33.1] | 1 | PDF | PDF |
| 162894 |  | \$50.00 | | | | PDF | PDF |
| 162895 |  | \$58.00 | | | | PDF | PDF |
| 162896 |  | \$92.00 | Monitor Mounting Joint | | | PDF | PDF |
| 162898 |  | \$93.00 | Monitor Holder | | | PDF | PDF |
| 162899 |  | \$325.00 | 4-Axis Mounting Support | 10 [22.0] | | PDF | PDF |
| 162900 |  | \$375.00 | 5-Axis Mounting Support | | | PDF | PDF |
| 162901 |  | \$600.00 | 4-Axis Workstation | 8 [17.6] | PDF | PDF | |

FATH® T-Slotted Rail Accessories

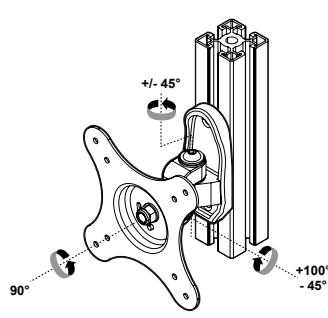
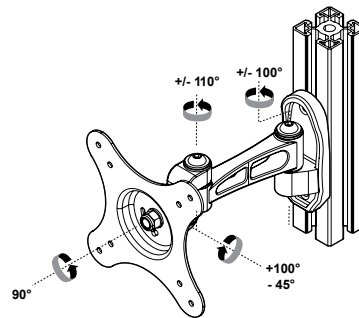
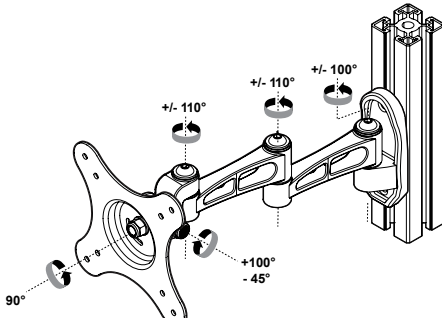
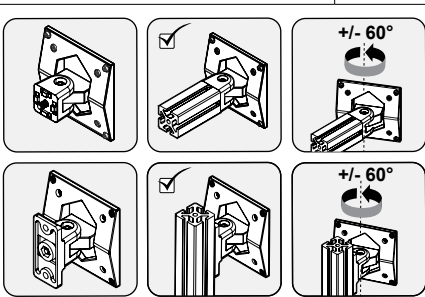
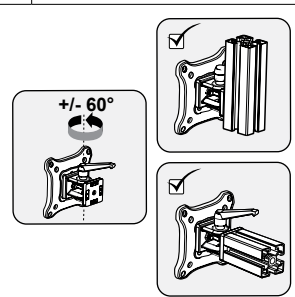
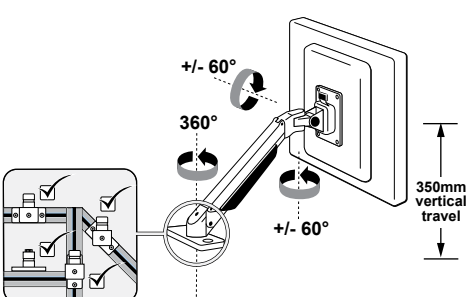
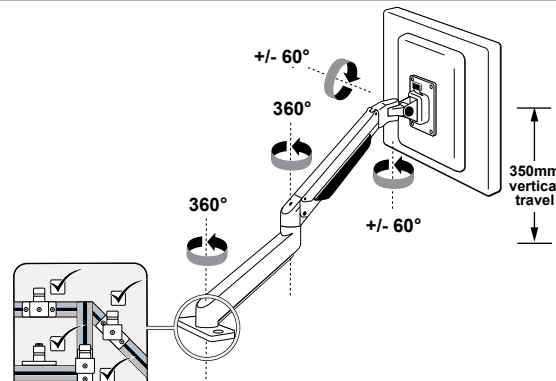
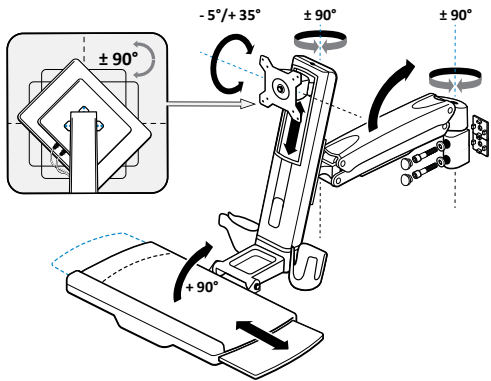

Monitor Mounts - Continued

| Monitor Mounts Adjustments | | |
|---|--|--|
|  <p>162893</p> |  <p>162894</p> |  <p>162895</p> |
|  <p>162896</p> |  <p>162898</p> | |
|  <p>162899</p> |  <p>162900</p> | |
|  <p>162901</p> | | |

FATH® T-Slotted Rail Accessories

Workstation Components

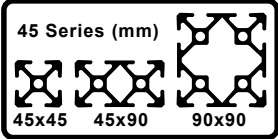

| 45 Series Workstation Components | | | | | | | |
|----------------------------------|---|---|--|---|------------------|----------------|----------------------------|
| | | Fits  Slot Size 10 | |  | | | |
| Part Number | Part Image | Price | Description | Load Rating kg [lb] | Pack Quantity | Material | Drawing Link |
| <u>162902</u> |  | \$185.00 | Keyboard Holder (requires mounting solution, designer's choice) | n/a | 1 | Aluminum/nylon | <u>PDF</u> |
| <u>162966</u> |  | \$2.25 | Label Clip | | 10 | PVC | <u>PDF</u> |

Workstation Components Installation

Keyboard Holder (mounting example)

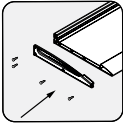
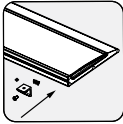
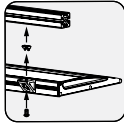
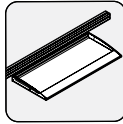
Label Clip

