

FATH® T-Slotted Rail Accessories

Connecting Components

- Connects two or three T-slot rails together
- Recommended ADC Fastener based on part feature, slot depth and core hole
- Material: varies by part



10 Series Connecting Components

Fits Slot Size 6

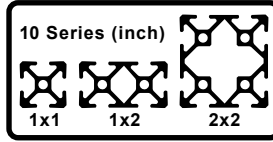

Part Number	Part Image	Price	Description	Fits Profile	Material	Recommended Screw Fastener (ADC Part Number)		Pack Quantity	Drawing Link	
						Core Hole Attachment 1	*T-Slot Attachment 2			
148953		\$8.25	2d Cube Connector	1 x 1in	Die-cast aluminum	161103	Socket Head Cap Screw 1/4-20 x 7/16" **	1	PDF	
166230		\$10.00				Fasteners Included (161103)			PDF	
148956		\$10.50	3d Cube Connector			161103	n/a		PDF	
166231		\$12.00				161103	PDF			
151042		\$4.25	Angle Connector			1 x 2in	Fasteners Included (161103)		Fasteners Included (151040 & 151039)	PDF
166232		\$4.75					161103		151040	PDF
151043		\$7.50					161103		151040	PDF
166233		\$8.00					161103		151040	PDF
163007		\$10.50	Screw Connector	1 x 1in	Zinc plated steel	Designer's choice	n/a	10	PDF	

*T-Slot Nut also required.

** Recommended fastener not available from AutomationDirect.com

FATH® T-Slotted Rail Accessories

Connecting Components - Continued

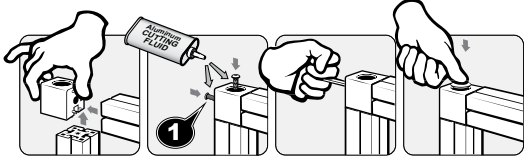
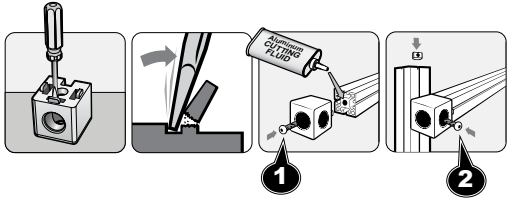
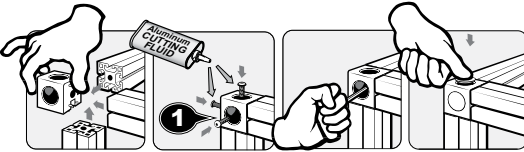
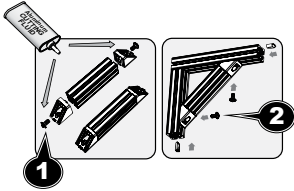
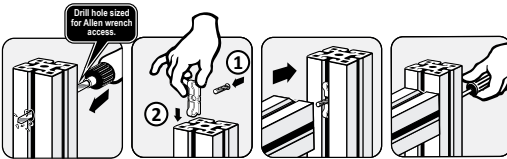









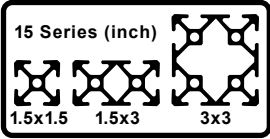

Connecting Components Installation	
Core Hole Installation	T-Slot Installation
2D Cube Connector	
	
3D Cube Connector	
	n/a
Angle Connector	
	
Screw Connector	
	

FATH® T-Slotted Rail Accessories

Connecting Components

- Connects two or three T-slot rails together.
- Recommended ADC Fastener based on part feature, slot depth and core hole.
- Material: varies by part







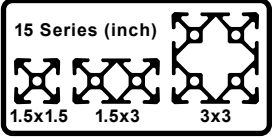

15 Series Connecting Components											
		Fits 									
Part Number	Part Image	Price	Description	Fits Profile	Material	Recommended Screw Fastener (ADC Part Number)		Pack Quantity	Drawing Link		
						Core Hole Attachment 1	*T-Slot Attachment 2				
148954		\$10.00	2d Cube Connector	1.5 x 1.5in	Die-cast aluminum	Fasteners Included (161105)	151100	1	PDF		
166302		\$12.00									
148957		\$11.50	3d Cube Connector								
166303		\$13.00									
151107		\$7.50	Angle Connector			1.5 x 3in				Fasteners Included (161105)	Fasteners Included (161054 & 162998)
166304		\$8.00								161105	161054
151108		\$11.00		Fasteners Included (161105)	Fasteners Included (161054 & 151099)						
166305		\$13.00		161105	161054						
151102		\$23.50	Duo Connector	All 15 Series	Steel	n/a	n/a	10	PDF		
151103		\$96.00	T-Matic Connector		Zinc plated steel				PDF		
151104		\$59.00	Automatic Connector		Steel				1	PDF	

*T-Slot Nut also required.

FATH® T-Slotted Rail Accessories

Connecting Components - Continued

15 Series Connecting Components - Continued										
		Fits 								
Part Number	Part Image	Price	Description	Fits Profile	Material	Recommended Screw Fastener (ADC Part Number)		Pack Quantity	Drawing Link	
						Core Hole Attachment 1	*T-Slot Attachment 2			
<u>151105</u>		\$9.50	Automatic Butt Connector	All 15 Series	Steel	n/a	n/a	1	<u>PDF</u>	
<u>151106</u>		\$8.50	Milling Connector		Zinc plated steel				n/a	<u>PDF</u>
<u>151109</u>		\$15.50	Connecting Strip		Zinc plated steel				n/a	<u>PDF</u>
<u>162891</u>		\$13.00	Direct Connector		Steel				Fasteners included	<u>PDF</u>
<u>162961</u>		\$11.50	Miter Connector		Steel				M8-1.25 x 8mm set screw (4) included	<u>PDF</u>
<u>163009</u>		\$13.25	Screw Connector	1.5 x 1.5in	Zinc plated steel	Designer's choice	10	<u>PDF</u>		

*T-Slot Nut also required

FATH® T-Slotted Rail Accessories

Connecting Components - Continued

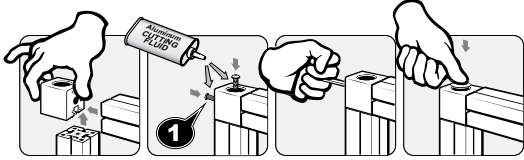
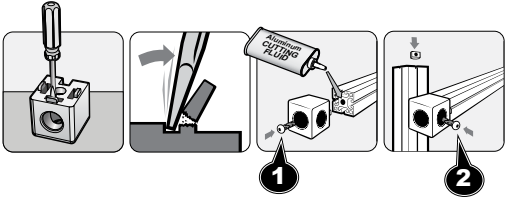
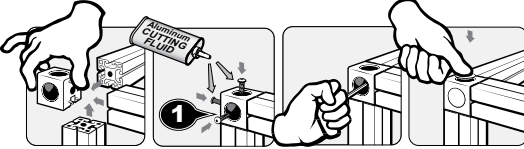
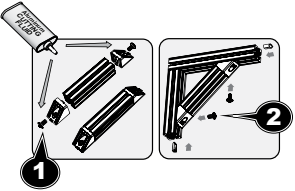
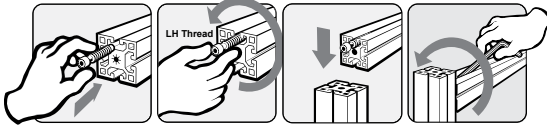
Connecting Components Installation	
Core Hole Installation	T-Slot Installation
<p>2D Cube Connector</p> 	
<p>3D Cube Connector</p> 	<p>n/a</p>
<p>Angle Connector</p> 	
<p>Duo Connector</p> <p>n/a</p>	

FATH® T-Slotted Rail Accessories

Connecting Components - Continued







Connecting Components Installation	
T-Slot Installation	
T-matic Connector	
Automatic Connector	
Automatic Butt Connector	
Milling Connector	
Connecting Strip	
Direct Connector	
Screw Connector	
Miter Connector	

FATH® T-Slotted Rail Accessories

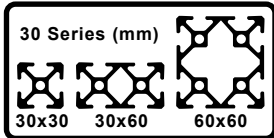
Connecting Components

- Connects two or three T-slot rails together
- Recommended ADC Fastener based on part feature, slot Depth and core hole
- Material: varies by part



30 Series Connecting Components										
		Fits 								
Part Number	Part Image	Price	Description	Fits Profile	Material	Recommended Screw Fastener (ADC Part Number)		Pack Quantity	Drawing Link	
						Core Hole Attachment 1	*T-Slot Attachment 2			
151185		\$9.50	2d Cube Connector	30 x 30mm 30 x 60mm 60 x 60mm	Die-cast aluminum	Fasteners Included (161085)	161083	1	PDF	
151186		\$10.00	3d Cube Connector			161085	n/a		PDF	
151187		\$5.75	Angle Connector	30 x 30mm		151241 Requires manually tapping core hole to M8-1.25 x 20 DP	161066		PDF	
151188		\$9.75		30 x 60mm					PDF	
162961		\$11.50	Miter Connector	30 x 30mm 30 x 60mm 60 x 60mm	Steel	n/a	M8-1.25 x 8mm set screw (4) included		PDF	
163008		\$10.75	Screw Connector		Zinc plated steel	Designer's choice	n/a		10	PDF

*T-Slot Nut also required.

FATH® T-Slotted Rail Accessories

Connecting Components - Continued

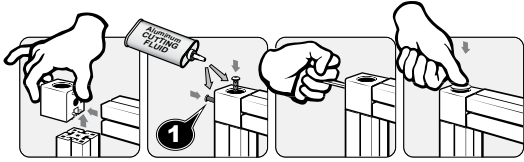
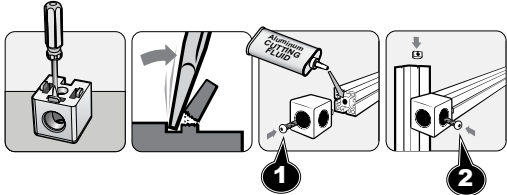
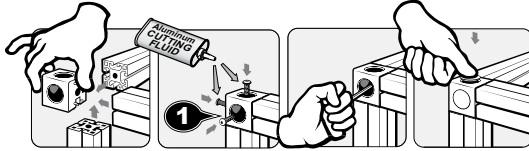
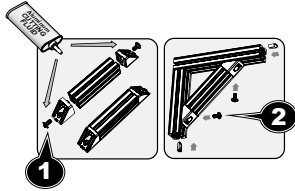
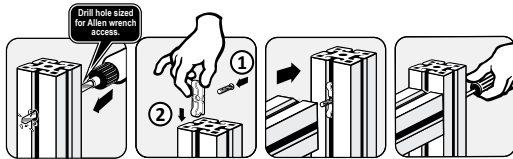
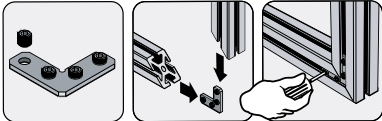





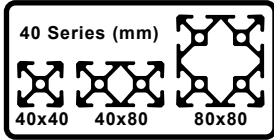

Connecting Components Installation	
Core Hole Installation	T-Slot Installation
2D Cube Connector 	
3D Cube Connector 	n/a
Angle Connector 	
Screw Connector 	
Miter Connector 	

FATH® T-Slotted Rail Accessories

Connecting Components

- Connects two or three T-slot rails together
- Recommended ADC Fastener based on part feature, slot Depth and core hole
- Material: varies by part



40 Series Connecting Components										
		Fits 								
Part Number	Part Image	Price	Description	Fits Profile	Material	Recommended Screw Fastener (ADC Part Number)		Pack Quantity	Drawing Link	
						Core Hole Attachment 1	*T-Slot Attachment 2			
148958		\$10.00	2d Cube Connector	40 x 40mm	Die-cast aluminum	161105	2	1	PDF	
166369		\$12.00							161085	PDF
148959		\$11.00	3d Cube Connector						PDF	
166370		\$13.00							n/a	PDF
151217		\$13.00	Angle Connector						40 x 80mm	PDF
166371		\$16.00								161067
151218		\$12.75		PDF						
166372		\$16.00		161068	PDF					

*T-Slot Nut **3** also required.









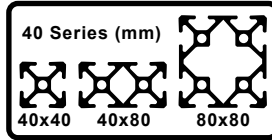

FATH® T-Slotted Rail Accessories

Connecting Components - Continued

40 Series Connecting Components - Continued

Fits  Slot Size 8



Part Number	Part Image	Price	Description	Fits Profile	Material	Recommended Screw Fastener (ADC Part Number)		Pack Quantity	Drawing Link		
						Core Hole Attachment 1	*T-Slot Attachment 2				
151102		\$23.50	Duo Connector	All 40 Series	Steel	n/a	n/a	10	PDF		
151103		\$96.00	T-Matic Connector		Zinc plated steel				PDF		
151104		\$59.00	Automatic Connector		Steel				PDF		
151105		\$9.50	Automatic Butt Connector		n/a			1	PDF		
151106		\$8.50	Milling Connector		Zinc plated steel				PDF		
151109		\$15.50	Connecting Strip		Zinc plated steel				PDF		
162891		\$13.00	Direct Connector		Steel			Fasteners included	PDF		
162961		\$11.50	Miter Connector		Steel			n/a	M8-1.25 x 8mm set screw (4) included	PDF	
162975		\$21.00	Clamp Profile Connector works with 162976		Die-cast zinc			161105 (2) included with kit	n/a	PDF	
162976		\$5.50	Mounting Element works with 162975		Steel			n/a	Fasteners included	PDF	
163009		\$13.25	Screw Connector		Zinc plated steel			Designer's choice	n/a	10	PDF

*T-Slot Nut also required.

FATH® T-Slotted Rail Accessories

Connecting Components - Continued

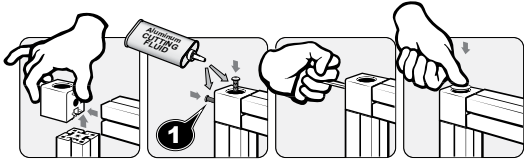
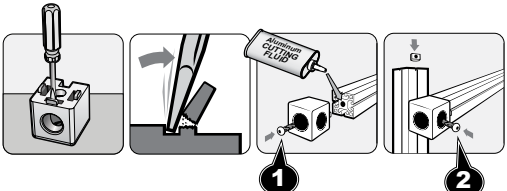
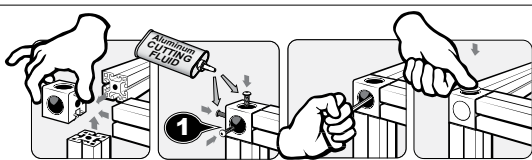
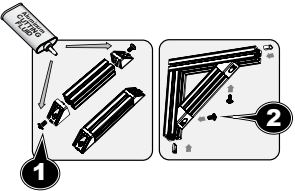
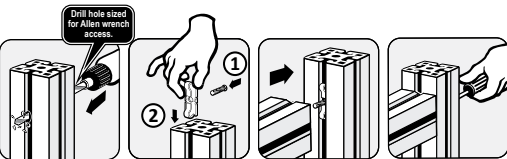
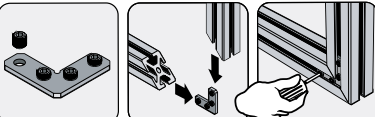
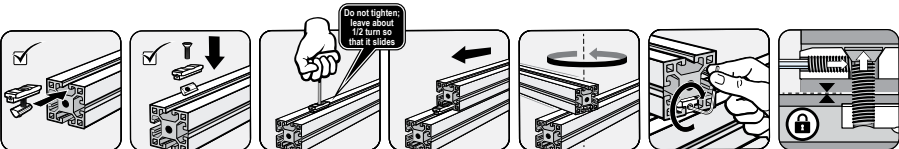
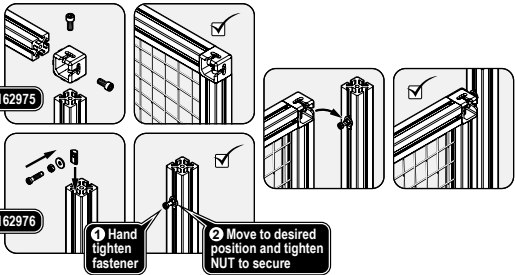
Connecting Components Installation	
Core Hole Installation	T-Slot Installation
<p>2D Cube Connector</p> 	
<p>3D Cube Connector</p> 	<p>n/a</p>
<p>Angle Connector</p> 	
<p>Screw Connector</p> 	
<p>Miter Connector</p> 	
<p>Direct Connector</p> 	
<p>Clamp Profile Connector</p> 	

FATH® T-Slotted Rail Accessories

Connecting Components - Continued

Connecting Components Installation	
T-Slot Installation	
Duo Connector	
T-matic Connector	
Automatic Connector	
Automatic Butt Connector	
Milling Connector	
Connecting Strip	

FATH® T-Slotted Rail Accessories

Connecting Components

- Connects two or three T-slot rails together
- Recommended ADC Fastener based on part feature, slot Depth and core hole
- Material: varies by part



45 Series Connecting Components

Fits Slot Size 10

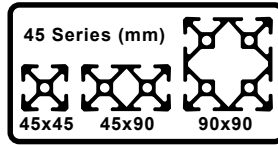

Part Number	Part Image	Price	Description	Fits Profile	Material	Recommended Screw Fastener (ADC Part Number)		Pack Quantity	Drawing Link
						Core Hole Attachment 1	*T-Slot Attachment 2		
<u>148960</u>		\$11.00	2d Cube Connector	45 x 45mm	Die-cast aluminum	<u>161110</u>	<u>161068</u>	1	<u>PDF</u>
<u>148961</u>		\$11.00	3d Cube Connector			Fasteners Included (<u>161110</u>)	n/a		<u>PDF</u>
<u>151246</u>		\$10.00	Angle Connector			45 x 90mm	<u>161110</u>		<u>151241</u>
<u>151247</u>		\$16.50		<u>PDF</u>					
** <u>151242</u>		\$96.00	T-Matic Connector	All 45 Light Series (45-xxxxCL)	Zinc plated steel	n/a	n/a	10	<u>PDF</u>
** <u>151243</u>		\$59.00	Automatic Connector		Steel				<u>PDF</u>
** <u>151244</u>		Retired	Automatic Butt Connector		Steel				<u>PDF</u>
<u>151245</u>		\$11.50	Milling Connector	All 45 Series	Zinc plated steel	n/a	n/a	1	<u>PDF</u>
<u>151248</u>		\$18.00	Connecting Strip						Steel
<u>162892</u>		\$13.00	Direct Connector		Steel			Fasteners included	<u>PDF</u>
<u>162962</u>		\$12.50	Miter Connector					M10-1.25 x 8mm set screw (4) included	<u>PDF</u>

*T-Slot Nut also required.

** Does not fit 45 standard series (45-xxxxC)

FATH® T-Slotted Rail Accessories

Connecting Components - Continued

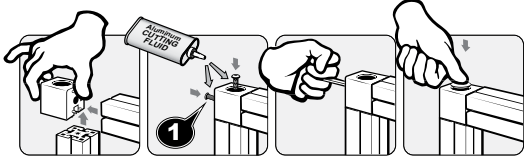
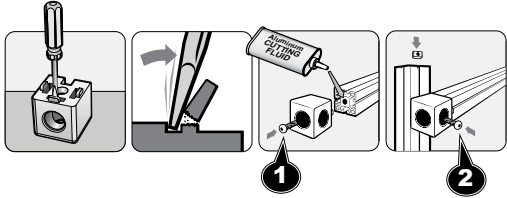
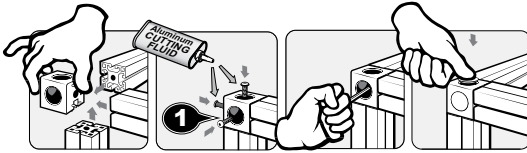
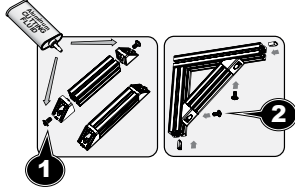
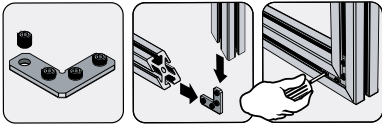
Connecting Components Installation	
Core Hole Installation	T-Slot Installation
<p>2D Cube Connector</p> 	
<p>3D Cube Connector</p> 	<p>n/a</p>
<p>Angle Connector</p> 	
<p>Miter Connector</p> 	

FATH® T-Slotted Rail Accessories

Connecting Components - Continued

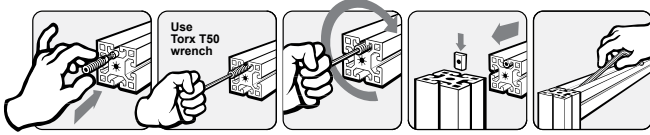
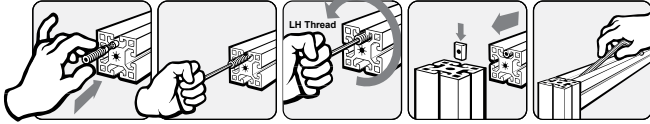
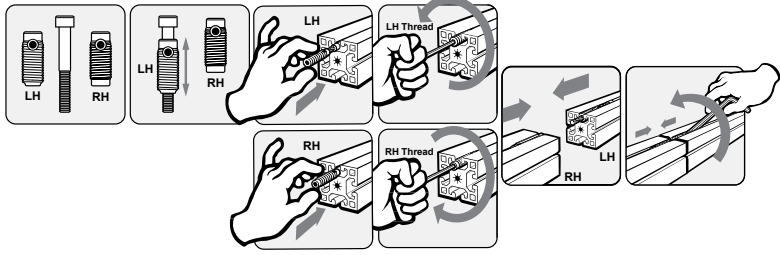
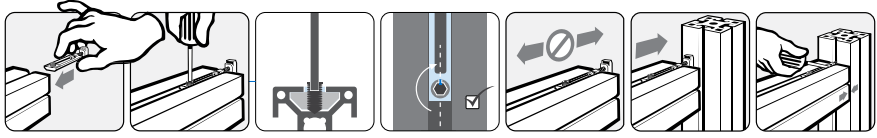
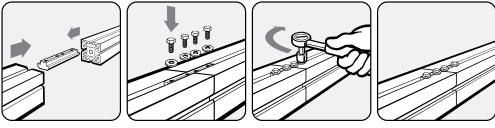
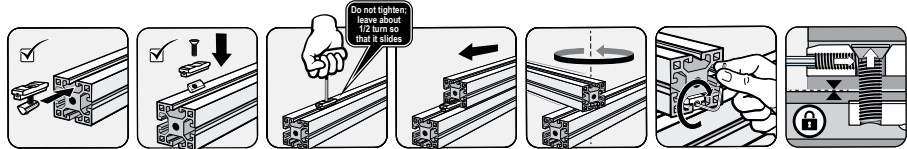
Connecting Components Installation	
T-Slot Installation	
T-matic Connector	
Automatic Connector	
Automatic Butt Connector	
Milling Connector	
Connecting Strip	
Direct Connector	
Miter Connector	