

# FATH® T-Slotted Rail Accessories

## Connecting Components

- Connects two or three T-slot rails together
- Recommended ADC Fastener based on part feature, slot depth and core hole
- Material: varies by part



### 10 Series Connecting Components

Fits Slot Size 6

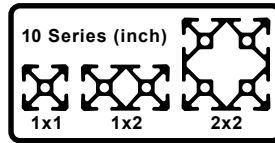

Part Number	Part Image	Price	Description	Fits Profile	Material	Recommended Screw Fastener (ADC Part Number)		Pack Quantity	Drawing Link
						Core Hole Attachment <b>1</b>	*T-Slot Attachment <b>2</b>		
<a href="#">148953</a>		\$8.25	2d Cube Connector	1 x 1in	Die-cast aluminum	<a href="#">161103</a>	Socket Head Cap Screw 1/4-20 x 7/16" **	1	<a href="#">PDF</a>
<a href="#">166230</a>		\$10.00							<a href="#">PDF</a>
<a href="#">148956</a>		\$10.50	3d Cube Connector	1 x 1in	Die-cast aluminum	<a href="#">161103</a>	n/a	1	<a href="#">PDF</a>
<a href="#">166231</a>		\$12.00							<a href="#">PDF</a>
<a href="#">151042</a>		\$4.25	Angle Connector	1 x 2in	Die-cast aluminum	<a href="#">161103</a>	151040	1	<a href="#">PDF</a>
<a href="#">166232</a>		\$4.75							<a href="#">PDF</a>
<a href="#">151043</a>		\$7.50							<a href="#">PDF</a>
<a href="#">166233</a>		\$8.00							<a href="#">PDF</a>
<a href="#">163007</a>		\$10.50	Screw Connector	1 x 1in	Zinc plated steel	Designer's choice	n/a	10	<a href="#">PDF</a>

\*T-Slot Nut also required.

\*\* Recommended fastener not available from AutomationDirect.com

# FATH® T-Slotted Rail Accessories

## Connecting Components - Continued

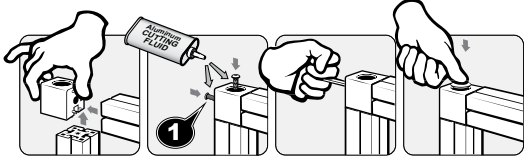
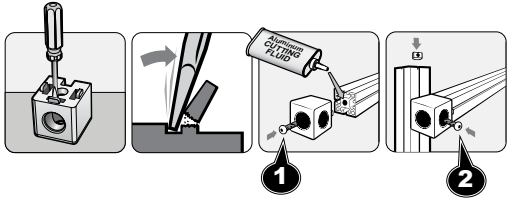
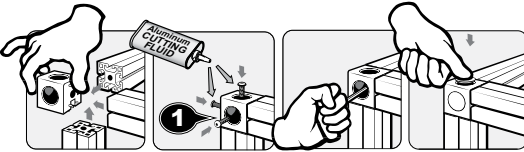
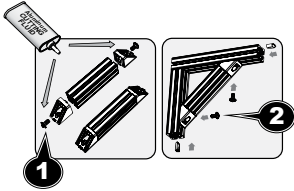
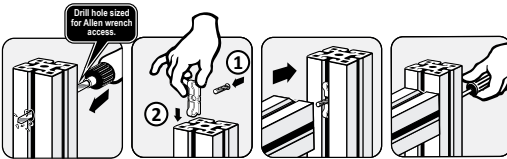
Connecting Components Installation	
Core Hole Installation	T-Slot Installation
<b>2D Cube Connector</b>	
	
<b>3D Cube Connector</b>	
	n/a
<b>Angle Connector</b>	
	
<b>Screw Connector</b>	
	

# FATH® T-Slotted Rail Accessories

## Connecting Components

- Connects two or three T-slot rails together.
- Recommended ADC Fastener based on part feature, slot depth and core hole.
- Material: varies by part



### 15 Series Connecting Components

Fits Slot Size 8

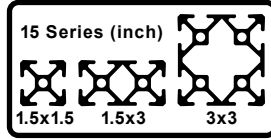





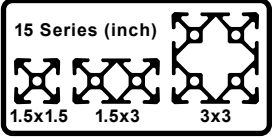

Part Number	Part Image	Price	Description	Fits Profile	Material	Recommended Screw Fastener (ADC Part Number)		Pack Quantity	Drawing Link
						Core Hole Attachment <b>1</b>	*T-Slot Attachment <b>2</b>		
<a href="#">148954</a>		\$10.00	2d Cube Connector	1.5 x 1.5in	Die-cast aluminum	161105	151100	1	<a href="#">PDF</a>
<a href="#">166302</a>		\$12.00							<a href="#">PDF</a>
<a href="#">148957</a>		\$11.50	3d Cube Connector	1.5 x 1.5in	Die-cast aluminum	161105	151100	1	<a href="#">PDF</a>
<a href="#">166303</a>		\$13.00							<a href="#">PDF</a>
<a href="#">151107</a>		\$7.50	Angle Connector	1.5 x 3in	Die-cast aluminum	161105	161054	1	<a href="#">PDF</a>
<a href="#">166304</a>		\$8.00							<a href="#">PDF</a>
<a href="#">151108</a>		\$11.00							<a href="#">PDF</a>
<a href="#">166305</a>		\$13.00							<a href="#">PDF</a>
<a href="#">151102</a>		\$23.50	Duo Connector	All 15 Series	Steel	n/a	n/a	10	<a href="#">PDF</a>
<a href="#">151103</a>		\$96.00	T-Matic Connector		Zinc plated steel				<a href="#">PDF</a>
<a href="#">151104</a>		\$59.00	Automatic Connector		Steel				1

\*T-Slot Nut also required.

# FATH® T-Slotted Rail Accessories

## Connecting Components - Continued

15 Series Connecting Components - Continued										
		Fits 								
Part Number	Part Image	Price	Description	Fits Profile	Material	Recommended Screw Fastener (ADC Part Number)		Pack Quantity	Drawing Link	
						Core Hole Attachment <b>1</b>	*T-Slot Attachment <b>2</b>			
<a href="#"><u>151105</u></a>		\$9.50	Automatic Butt Connector	All 15 Series	Steel	n/a	n/a	1	<a href="#"><u>PDF</u></a>	
<a href="#"><u>151106</u></a>		\$8.50	Milling Connector		Zinc plated steel				n/a	<a href="#"><u>PDF</u></a>
<a href="#"><u>151109</u></a>		\$15.50	Connecting Strip		Zinc plated steel				n/a	<a href="#"><u>PDF</u></a>
<a href="#"><u>162891</u></a>		\$13.00	Direct Connector		Steel				Fasteners included	<a href="#"><u>PDF</u></a>
<a href="#"><u>162961</u></a>		\$11.50	Miter Connector		Steel				M8-1.25 x 8mm set screw (4) included	<a href="#"><u>PDF</u></a>
<a href="#"><u>163009</u></a>		\$13.25	Screw Connector	1.5 x 1.5in	Zinc plated steel	Designer's choice	10	<a href="#"><u>PDF</u></a>		

\*T-Slot Nut also required

# FATH® T-Slotted Rail Accessories

## Connecting Components - Continued

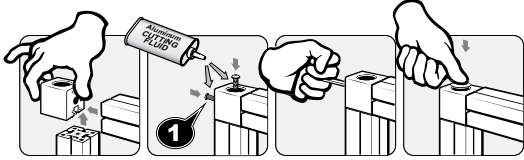
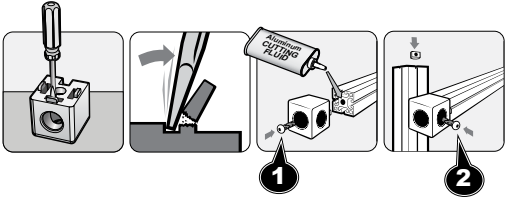
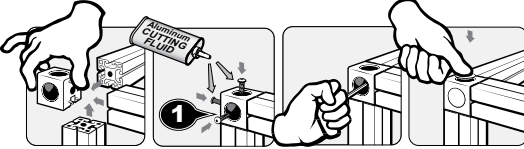
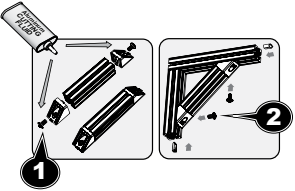
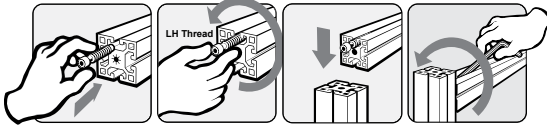
Connecting Components Installation	
Core Hole Installation	T-Slot Installation
<p><b>2D Cube Connector</b></p> 	
<p><b>3D Cube Connector</b></p> 	<p>n/a</p>
<p><b>Angle Connector</b></p> 	
<p><b>Duo Connector</b></p> <p>n/a</p>	

# FATH® T-Slotted Rail Accessories

## Connecting Components - Continued

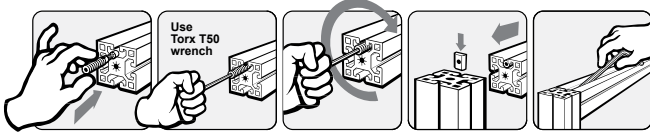
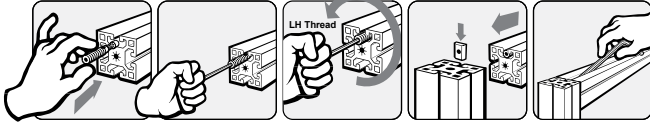
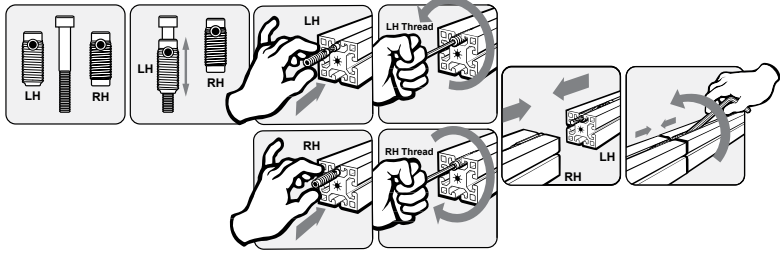
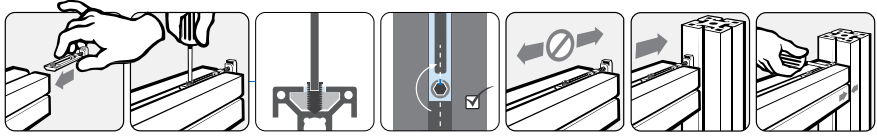
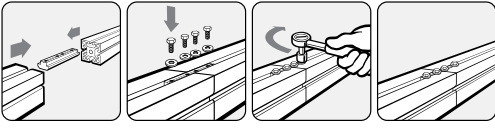
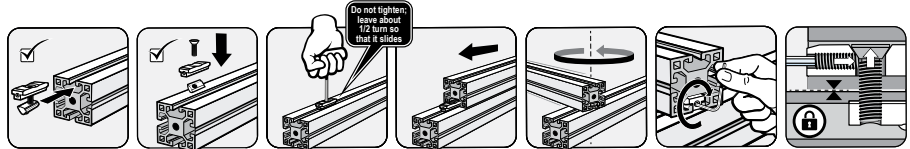
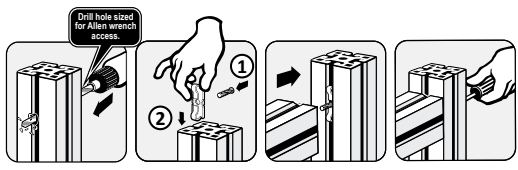
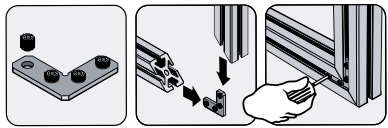





Connecting Components Installation	
<b>T-Slot Installation</b>	
<b>T-matic Connector</b>	
	
<b>Automatic Connector</b>	
	
<b>Automatic Butt Connector</b>	
	
<b>Milling Connector</b>	
	
<b>Connecting Strip</b>	
	
<b>Direct Connector</b>	
	
<b>Screw Connector</b>	
	
<b>Miter Connector</b>	
	

# FATH® T-Slotted Rail Accessories

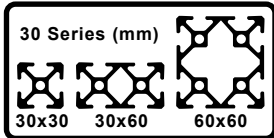
## Connecting Components

- Connects two or three T-slot rails together
- Recommended ADC Fastener based on part feature, slot Depth and core hole
- Material: varies by part



30 Series Connecting Components										
		Fits 								
Part Number	Part Image	Price	Description	Fits Profile	Material	Recommended Screw Fastener (ADC Part Number)		Pack Quantity	Drawing Link	
						Core Hole Attachment <b>1</b>	*T-Slot Attachment <b>2</b>			
<a href="#">151185</a>		\$9.50	2d Cube Connector	30 x 30mm 30 x 60mm 60 x 60mm	Die-cast aluminum	161085	161083	1	<a href="#">PDF</a>	
<a href="#">151186</a>		\$10.00	3d Cube Connector				n/a		<a href="#">PDF</a>	
<a href="#">151187</a>		\$5.75	Angle Connector			30 x 30mm	151241 Requires manually tapping core hole to M8-1.25 x 20 DP		161066	<a href="#">PDF</a>
<a href="#">151188</a>		\$9.75		30 x 60mm	<a href="#">PDF</a>					
<a href="#">162961</a>		\$11.50	Miter Connector	30 x 30mm 30 x 60mm 60 x 60mm	Steel	n/a	M8-1.25 x 8mm set screw (4) included		<a href="#">PDF</a>	
<a href="#">163008</a>		\$10.75	Screw Connector		Zinc plated steel	Designer's choice	n/a		10	<a href="#">PDF</a>

\*T-Slot Nut also required.

# FATH® T-Slotted Rail Accessories

## Connecting Components - Continued

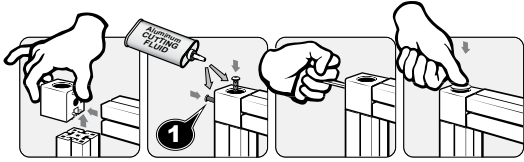
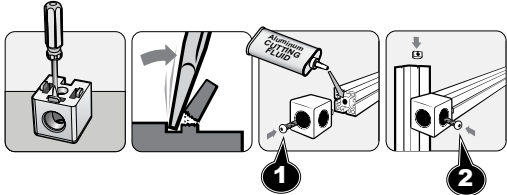
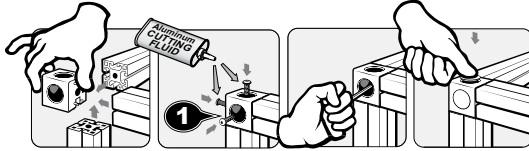
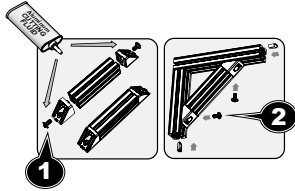
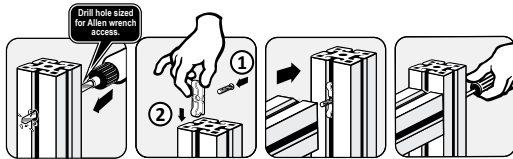
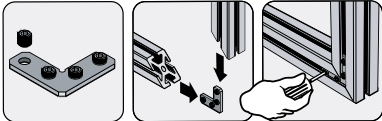
Connecting Components Installation	
Core Hole Installation	T-Slot Installation
<b>2D Cube Connector</b> 	
<b>3D Cube Connector</b> 	n/a
<b>Angle Connector</b> 	
<b>Screw Connector</b> 	
<b>Miter Connector</b> 	









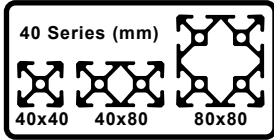

# FATH® T-Slotted Rail Accessories

## Connecting Components

- Connects two or three T-slot rails together
- Recommended ADC Fastener based on part feature, slot Depth and core hole
- Material: varies by part



40 Series Connecting Components										
		Fits 								
Part Number	Part Image	Price	Description	Fits Profile	Material	Recommended Screw Fastener (ADC Part Number)		Pack Quantity	Drawing Link	
						Core Hole Attachment <b>1</b>	*T-Slot Attachment <b>2</b>			
<a href="#">148958</a>		\$10.00	2d Cube Connector	40 x 40mm	Die-cast aluminum	<a href="#">161105</a>	<b>2</b>	1	<a href="#">PDF</a>	
<a href="#">166369</a>		\$12.00							<a href="#">161085</a>	<a href="#">PDF</a>
<a href="#">148959</a>		\$11.00	3d Cube Connector						<a href="#">PDF</a>	
<a href="#">166370</a>		\$13.00							n/a	<a href="#">PDF</a>
<a href="#">151217</a>		\$13.00	Angle Connector						40 x 80mm	<a href="#">PDF</a>
<a href="#">166371</a>		\$16.00								<a href="#">161067</a>
<a href="#">151218</a>		\$12.75		<a href="#">PDF</a>						
<a href="#">166372</a>		\$16.00		<a href="#">161068</a>	<a href="#">PDF</a>					

\*T-Slot Nut **3** also required.









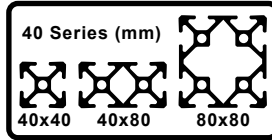

# FATH® T-Slotted Rail Accessories

## Connecting Components - Continued

### 40 Series Connecting Components - Continued

Fits  Slot Size 8



Part Number	Part Image	Price	Description	Fits Profile	Material	Recommended Screw Fastener (ADC Part Number)		Pack Quantity	Drawing Link		
						Core Hole Attachment <b>1</b>	*T-Slot Attachment <b>2</b>				
<a href="#">151102</a>		\$23.50	Duo Connector	All 40 Series	Steel	n/a	n/a	10	<a href="#">PDF</a>		
<a href="#">151103</a>		\$96.00	T-Matic Connector		Zinc plated steel				<a href="#">PDF</a>		
<a href="#">151104</a>		\$59.00	Automatic Connector		Steel				<a href="#">PDF</a>		
<a href="#">151105</a>		\$9.50	Automatic Butt Connector					n/a	1	<a href="#">PDF</a>	
<a href="#">151106</a>		\$8.50	Milling Connector		Zinc plated steel			<a href="#">PDF</a>			
<a href="#">151109</a>		\$15.50	Connecting Strip					<a href="#">PDF</a>			
<a href="#">162891</a>		\$13.00	Direct Connector		Steel			Fasteners included	1	<a href="#">PDF</a>	
<a href="#">162961</a>		\$11.50	Miter Connector		Steel			n/a		M8-1.25 x 8mm set screw (4) included	<a href="#">PDF</a>
<a href="#">162975</a>		\$21.00	Clamp Profile Connector works with <a href="#">162976</a>		Die-cast zinc			161105 (2) included with kit	n/a	<a href="#">PDF</a>	
<a href="#">162976</a>		\$5.50	Mounting Element works with <a href="#">162975</a>		Steel			n/a	Fasteners included	<a href="#">PDF</a>	
<a href="#">163009</a>		\$13.25	Screw Connector		Zinc plated steel			Designer's choice	n/a	10	<a href="#">PDF</a>

\*T-Slot Nut also required.

# FATH® T-Slotted Rail Accessories

## Connecting Components - Continued

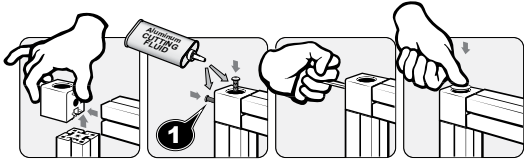
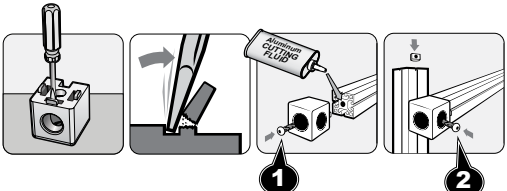
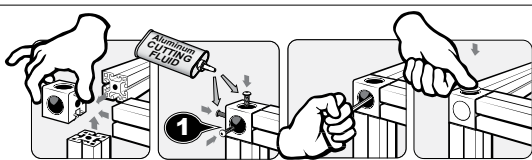
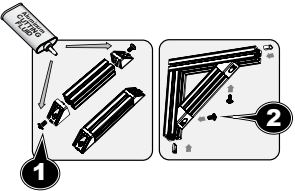
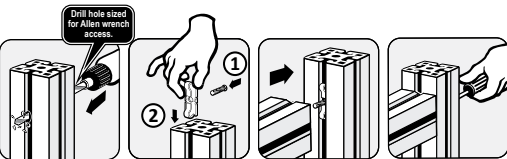
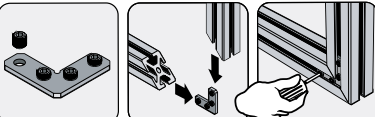
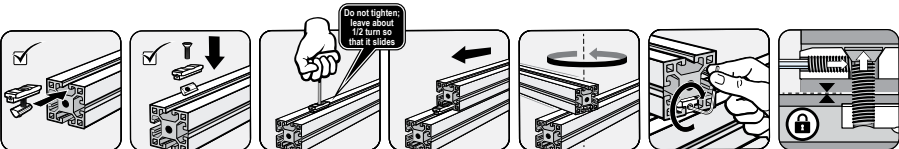
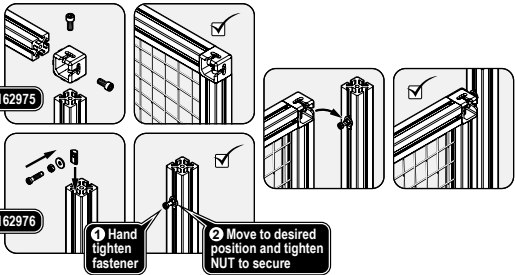
Connecting Components Installation	
Core Hole Installation	T-Slot Installation
<p><b>2D Cube Connector</b></p> 	
<p><b>3D Cube Connector</b></p> 	<p>n/a</p>
<p><b>Angle Connector</b></p> 	
<p><b>Screw Connector</b></p> 	
<p><b>Miter Connector</b></p> 	
<p><b>Direct Connector</b></p> 	
<p><b>Clamp Profile Connector</b></p> 	

# FATH® T-Slotted Rail Accessories

## Connecting Components - Continued

Connecting Components Installation	
T-Slot Installation	
<b>Duo Connector</b>	
<b>T-matic Connector</b>	
<b>Automatic Connector</b>	
<b>Automatic Butt Connector</b>	
<b>Milling Connector</b>	
<b>Connecting Strip</b>	

# FATH® T-Slotted Rail Accessories

## Connecting Components

- Connects two or three T-slot rails together
- Recommended ADC Fastener based on part feature, slot Depth and core hole
- Material: varies by part



### 45 Series Connecting Components

Fits Slot Size  
10

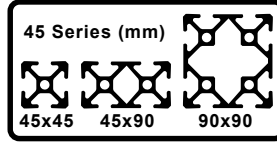

Part Number	Part Image	Price	Description	Fits Profile	Material	Recommended Screw Fastener (ADC Part Number)		Pack Quantity	Drawing Link
						Core Hole Attachment <b>1</b>	*T-Slot Attachment <b>2</b>		
<a href="#">148960</a>		\$11.00	2d Cube Connector	45 x 45mm	Die-cast aluminum	161110	<a href="#">161068</a>	1	<a href="#">PDF</a>
<a href="#">148961</a>		\$11.00	3d Cube Connector				n/a		<a href="#">PDF</a>
<a href="#">151246</a>		\$10.00	Angle Connector				<a href="#">151241</a>		<a href="#">PDF</a>
<a href="#">151247</a>		\$16.50		45 x 90mm	<a href="#">PDF</a>				
<b>**</b> <a href="#">151242</a>		\$96.00	T-Matic Connector	All 45 Light Series (45-xxxxCL)	Zinc plated steel	n/a	n/a	10	<a href="#">PDF</a>
<b>**</b> <a href="#">151243</a>		\$59.00	Automatic Connector		Steel				<a href="#">PDF</a>
<b>**</b> <a href="#">151244</a>		\$11.00	Automatic Butt Connector		Steel				<a href="#">PDF</a>
<a href="#">151245</a>		\$11.50	Milling Connector	All 45 Series	Zinc plated steel	n/a	1	<a href="#">PDF</a>	
<a href="#">151248</a>		\$18.00	Connecting Strip					Steel	<a href="#">PDF</a>
<a href="#">162892</a>		\$13.00	Direct Connector		Steel			Fasteners included	<a href="#">PDF</a>
<a href="#">162962</a>		\$12.50	Miter Connector					M10-1.25 x 8mm set screw (4) included	<a href="#">PDF</a>

\*T-Slot Nut also required.

\*\* Does not fit 45 standard series (45-xxxxC)

# FATH® T-Slotted Rail Accessories

## Connecting Components - Continued

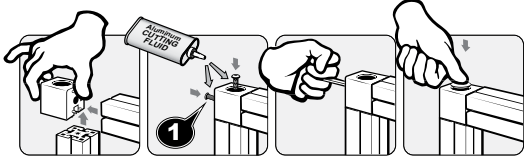
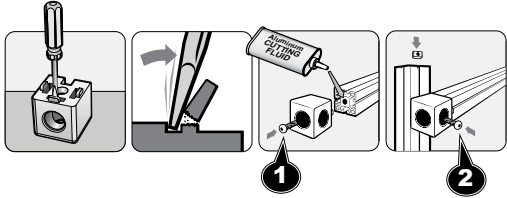
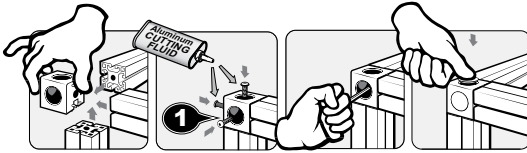
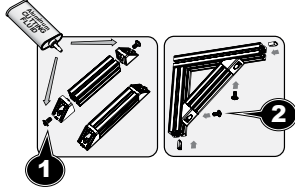
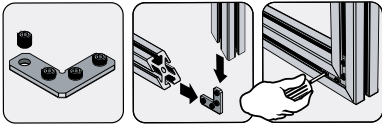
Connecting Components Installation	
Core Hole Installation	T-Slot Installation
<p><b>2D Cube Connector</b></p> 	
<p><b>3D Cube Connector</b></p> 	<p>n/a</p>
<p><b>Angle Connector</b></p> 	
<p><b>Miter Connector</b></p> 	

# FATH® T-Slotted Rail Accessories

## Connecting Components - Continued

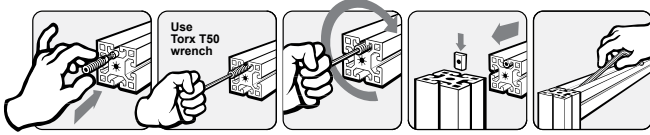
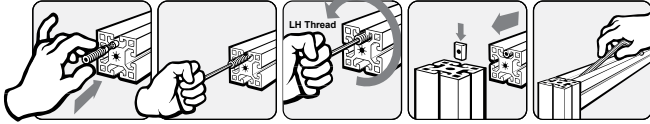
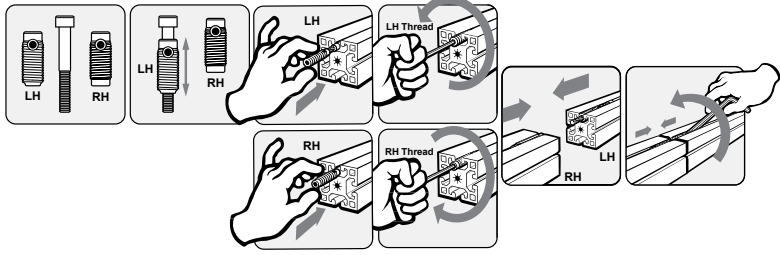
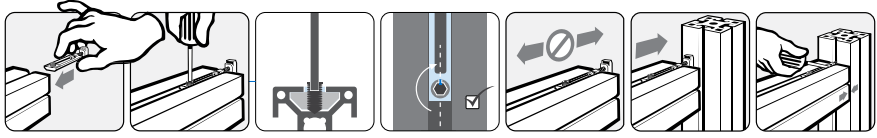
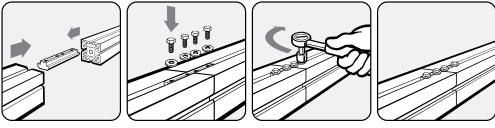
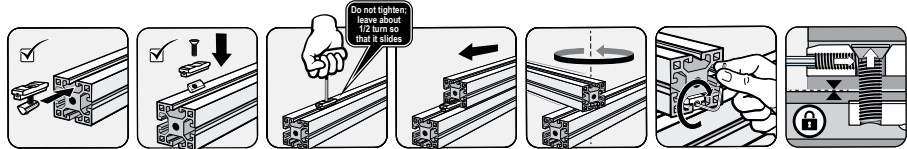
Connecting Components Installation	
T-Slot Installation	
<b>T-matic Connector</b>	
<b>Automatic Connector</b>	
<b>Automatic Butt Connector</b>	
<b>Milling Connector</b>	
<b>Connecting Strip</b>	
<b>Direct Connector</b>	
<b>Miter Connector</b>	