

FATH® T-Slotted Rail Accessories

Connecting Components

- Connects two or three T-slot rails together
- Recommended ADC Fastener based on part feature, slot depth and core hole
- Material: varies by part



10 Series Connecting Components

Fits Slot Size 6

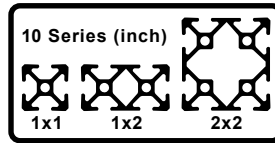

Part Number	Part Image	Price	Description	Fits Profile	Material	Recommended Screw Fastener (ADC Part Number)		Pack Quantity	Drawing Link
						Core Hole Attachment 1	*T-Slot Attachment 2		
148953		\$8.25	2d Cube Connector	1 x 1in	Die-cast aluminum	161103	Socket Head Cap Screw 1/4-20 x 7/16" **	1	PDF
166230		\$10.00							PDF
148956		\$10.50	3d Cube Connector	1 x 1in	Die-cast aluminum	161103	n/a	1	PDF
166231		\$12.00							PDF
151042		\$3.75	Angle Connector	1 x 2in	Die-cast aluminum	161103	151040	1	PDF
166232		\$4.00							PDF
151043		\$6.00							PDF
166233		\$7.00							PDF
163007		\$10.50	Screw Connector	1 x 1in	Zinc plated steel	Designer's choice	n/a	10	PDF

*T-Slot Nut also required.

** Recommended fastener not available from AutomationDirect.com

FATH® T-Slotted Rail Accessories

Connecting Components - Continued

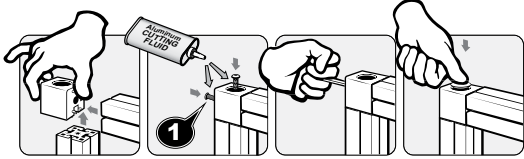
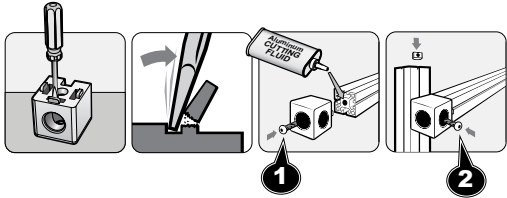
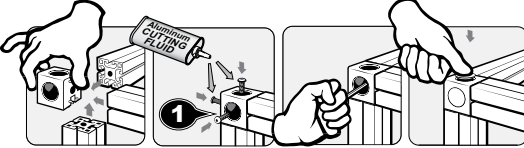
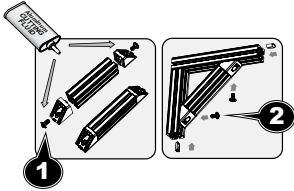
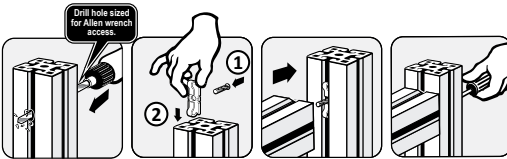
Connecting Components Installation	
Core Hole Installation	T-Slot Installation
2D Cube Connector	
	
3D Cube Connector	
	n/a
Angle Connector	
	
Screw Connector	
	

FATH® T-Slotted Rail Accessories

Connecting Components

- Connects two or three T-slot rails together.
- Recommended ADC Fastener based on part feature, slot depth and core hole.
- Material: varies by part



15 Series Connecting Components

Fits Slot Size 8

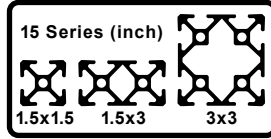





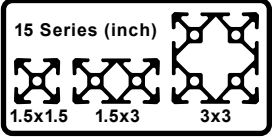

Part Number	Part Image	Price	Description	Fits Profile	Material	Recommended Screw Fastener (ADC Part Number)		Pack Quantity	Drawing Link
						Core Hole Attachment 1	*T-Slot Attachment 2		
148954		\$10.00	2d Cube Connector	1.5 x 1.5in	Die-cast aluminum	161105	151100	1	PDF
166302		\$12.00							PDF
148957		\$11.50	3d Cube Connector	1.5 x 1.5in	Die-cast aluminum	161105	151100	1	PDF
166303		\$13.00							PDF
151107		\$6.75	Angle Connector	1.5 x 3in	Die-cast aluminum	161054	161054	1	PDF
166304		\$8.00							PDF
151108		\$10.50							PDF
166305		\$12.00							PDF
151102		\$23.50	Duo Connector	All 15 Series	Steel	n/a	n/a	10	PDF
151103		\$96.00	T-Matic Connector		Zinc plated steel				PDF
151104		\$59.00	Automatic Connector		Steel				PDF

*T-Slot Nut also required.

FATH® T-Slotted Rail Accessories

Connecting Components - Continued

15 Series Connecting Components - Continued										
		Fits 								
Part Number	Part Image	Price	Description	Fits Profile	Material	Recommended Screw Fastener (ADC Part Number)		Pack Quantity	Drawing Link	
						Core Hole Attachment 1	*T-Slot Attachment 2			
<u>151105</u>		\$9.50	Automatic Butt Connector	All 15 Series	Steel	n/a	n/a	1	<u>PDF</u>	
<u>151106</u>		\$8.50	Milling Connector		Zinc plated steel				n/a	<u>PDF</u>
<u>151109</u>		\$15.50	Connecting Strip		Zinc plated steel				n/a	<u>PDF</u>
<u>162891</u>		\$13.00	Direct Connector		Steel				Fasteners included	<u>PDF</u>
<u>162961</u>		\$11.50	Miter Connector		Steel				M8-1.25 x 8mm set screw (4) included	<u>PDF</u>
<u>163009</u>		\$13.25	Screw Connector	1.5 x 1.5in	Zinc plated steel	Designer's choice	10	<u>PDF</u>		

*T-Slot Nut also required

FATH® T-Slotted Rail Accessories

Connecting Components - Continued

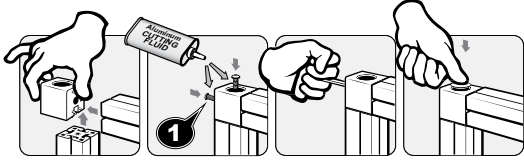
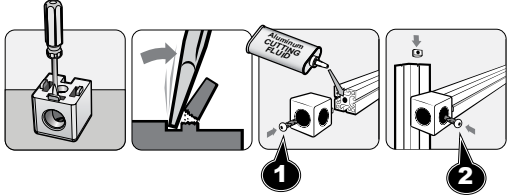
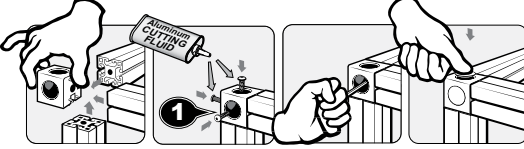
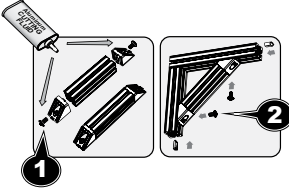
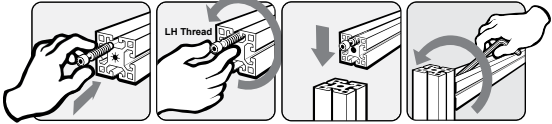
Connecting Components Installation	
Core Hole Installation	T-Slot Installation
<p>2D Cube Connector</p> 	
<p>3D Cube Connector</p> 	<p>n/a</p>
<p>Angle Connector</p> 	
<p>Duo Connector</p> <p>n/a</p>	

FATH® T-Slotted Rail Accessories

Connecting Components - Continued

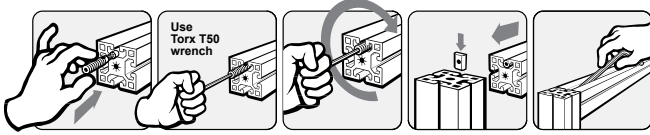
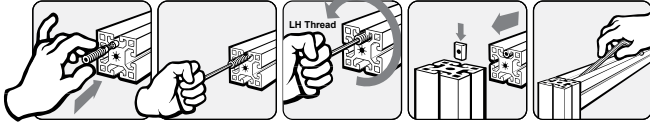
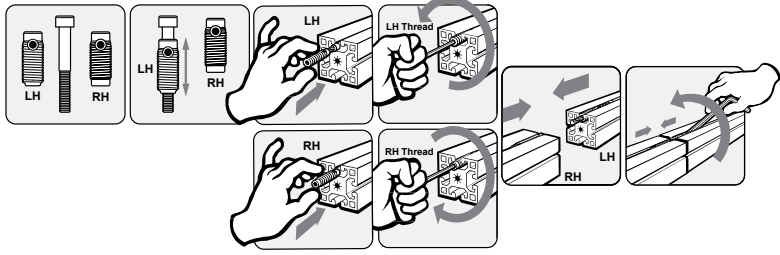
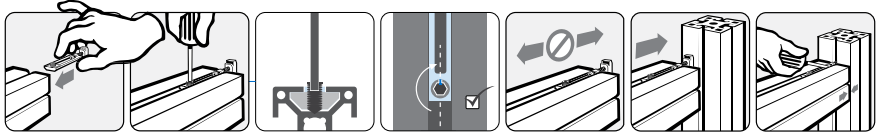
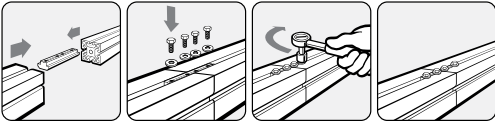
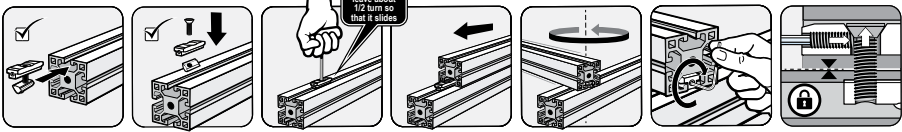
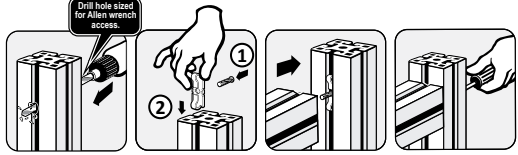
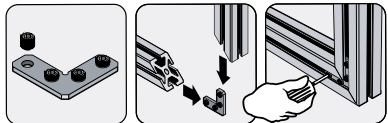





Connecting Components Installation	
T-Slot Installation	
T-matic Connector	
	
Automatic Connector	
	
Automatic Butt Connector	
	
Milling Connector	
	
Connecting Strip	
	
Direct Connector	
	
Screw Connector	
	
Miter Connector	
	

FATH® T-Slotted Rail Accessories

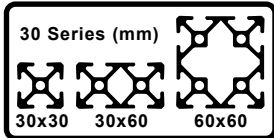
Connecting Components

- Connects two or three T-slot rails together
- Recommended ADC Fastener based on part feature, slot Depth and core hole
- Material: varies by part



30 Series Connecting Components										
		Fits 								
Part Number	Part Image	Price	Description	Fits Profile	Material	Recommended Screw Fastener (ADC Part Number)		Pack Quantity	Drawing Link	
						Core Hole Attachment 1	*T-Slot Attachment 2			
151185		\$9.50	2d Cube Connector	30 x 30mm 30 x 60mm 60 x 60mm	Die-cast aluminum	161085	161083	1	PDF	
151186		\$10.00	3d Cube Connector				n/a		PDF	
151187		\$4.75	Angle Connector			30 x 30mm	151241 Requires manually tapping core hole to M8-1.25 x 20 DP		161066	PDF
151188		\$7.25		30 x 60mm	PDF					
162961		\$11.50	Miter Connector	30 x 30mm 30 x 60mm 60 x 60mm	Steel	n/a	M8-1.25 x 8mm set screw (4) included		PDF	
163008		\$10.75	Screw Connector		Zinc plated steel	Designer's choice	n/a		10	PDF

*T-Slot Nut also required.

FATH® T-Slotted Rail Accessories

Connecting Components - Continued

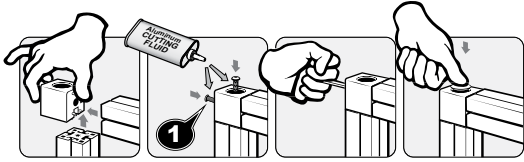
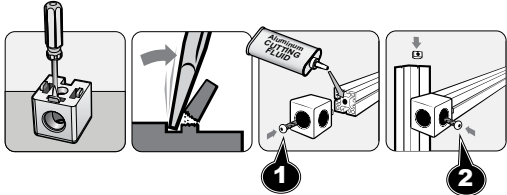
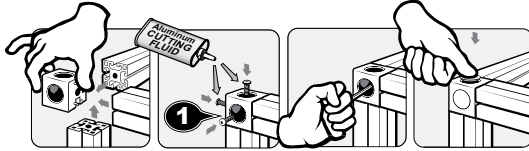
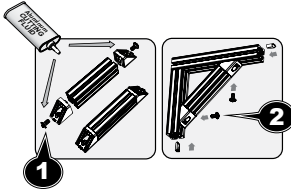
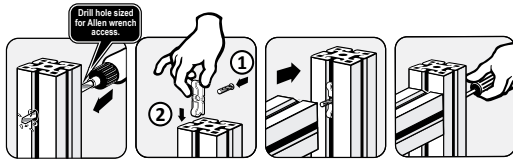
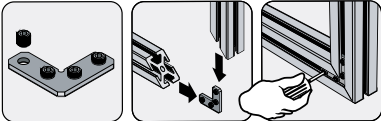
Connecting Components Installation	
Core Hole Installation	T-Slot Installation
2D Cube Connector 	
3D Cube Connector 	n/a
Angle Connector 	
Screw Connector 	
Miter Connector 	

FATH® T-Slotted Rail Accessories

Connecting Components

- Connects two or three T-slot rails together
- Recommended ADC Fastener based on part feature, slot Depth and core hole
- Material: varies by part



40 Series Connecting Components													
Part Number	Part Image	Price	Description	Fits Profile	Material	Recommended Screw Fastener (ADC Part Number)		Pack Quantity	Drawing Link				
						Core Hole Attachment 1	*T-Slot Attachment 2						
148958		\$10.00	2d Cube Connector	40 x 40mm	Die-cast aluminum	161105	161085	1	PDF				
166369		\$12.00							PDF				
148959		\$11.00	3d Cube Connector						n/a	PDF			
166370		\$13.00								PDF			
151217		\$13.00	Angle Connector							40 x 80mm	161067	161068	PDF
166371		\$16.00											PDF
151218		\$11.00		PDF									
166372		\$16.00		PDF									

*T-Slot Nut **3** also required.









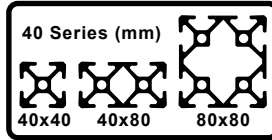

FATH® T-Slotted Rail Accessories

Connecting Components - Continued

40 Series Connecting Components - Continued

Fits  Slot Size 8



Part Number	Part Image	Price	Description	Fits Profile	Material	Recommended Screw Fastener (ADC Part Number)		Pack Quantity	Drawing Link		
						Core Hole Attachment 1	*T-Slot Attachment 2				
151102		\$23.50	Duo Connector	All 40 Series	Steel	n/a	n/a	10	PDF		
151103		\$96.00	T-Matic Connector		Zinc plated steel				PDF		
151104		\$59.00	Automatic Connector		Steel				PDF		
151105		\$9.50	Automatic Butt Connector		n/a			1	PDF		
151106		\$8.50	Milling Connector		Zinc plated steel				PDF		
151109		\$15.50	Connecting Strip		Zinc plated steel				PDF		
162891		\$13.00	Direct Connector		Steel			Fasteners included	1	PDF	
162961		\$11.50	Miter Connector		Steel			n/a		M8-1.25 x 8mm set screw (4) included	PDF
162975		\$21.00	Clamp Profile Connector works with 162976		Die-cast zinc			161105 (2) included with kit		n/a	PDF
162976		\$5.50	Mounting Element works with 162975		Steel			n/a	Fasteners included	PDF	
163009		\$13.25	Screw Connector		Zinc plated steel			Designer's choice	n/a	10	PDF

*T-Slot Nut also required.

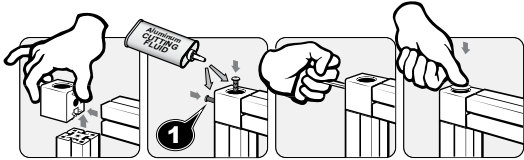
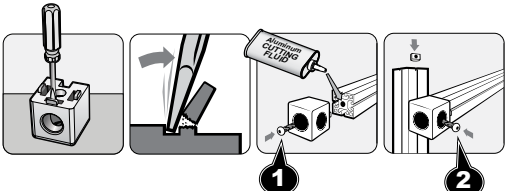
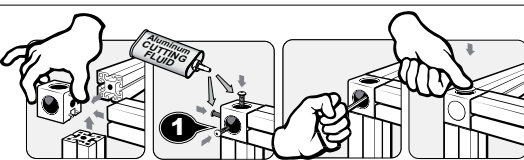
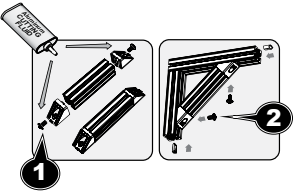
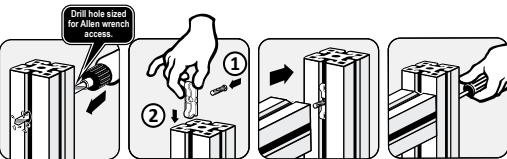
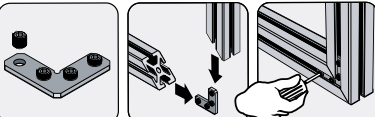
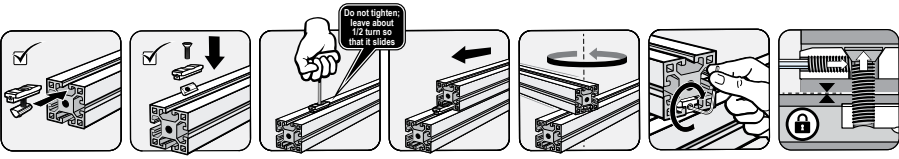
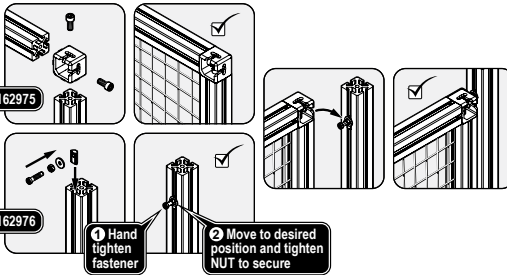

FATH® T-Slotted Rail Accessories

Connecting Components - Continued

Connecting Components Installation	
Core Hole Installation	T-Slot Installation
<p>2D Cube Connector</p> 	
<p>3D Cube Connector</p> 	<p>n/a</p>
<p>Angle Connector</p> 	
<p>Screw Connector</p> 	
<p>Miter Connector</p> 	
<p>Direct Connector</p> 	
<p>Clamp Profile Connector</p> 	

FATH® T-Slotted Rail Accessories

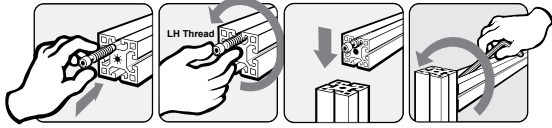
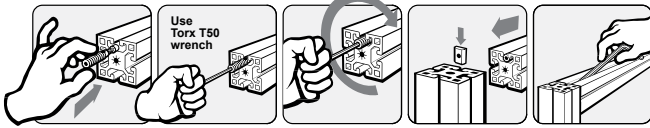
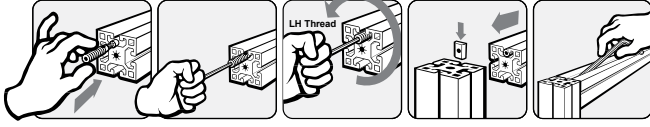
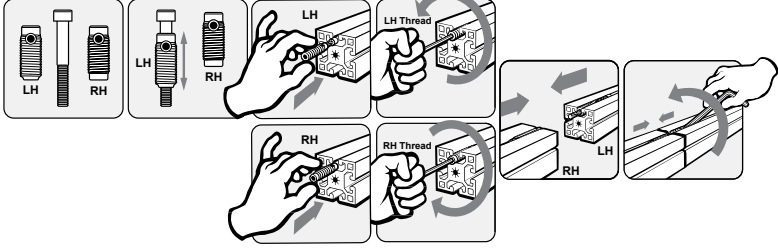
Connecting Components - Continued

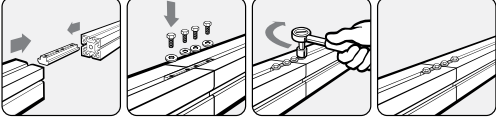
Connecting Components Installation	
T-Slot Installation	
Duo Connector	
T-matic Connector	
Automatic Connector	
Automatic Butt Connector	
Milling Connector	
Connecting Strip	

FATH® T-Slotted Rail Accessories

Connecting Components

- Connects two or three T-slot rails together
- Recommended ADC Fastener based on part feature, slot Depth and core hole
- Material: varies by part



45 Series Connecting Components

Fits Slot Size
10

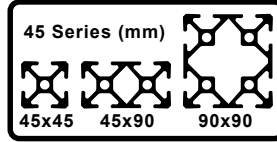

Part Number	Part Image	Price	Description	Fits Profile	Material	Recommended Screw Fastener (ADC Part Number)		Pack Quantity	Drawing Link
						Core Hole Attachment 1	*T-Slot Attachment 2		
148960		\$11.00	2d Cube Connector	45 x 45mm	Die-cast aluminum	161110	161068	1	PDF
148961		\$11.00	3d Cube Connector				n/a		PDF
151246		\$10.00	Angle Connector				45 x 90mm		151241
151247		\$16.50		PDF					
** 151242		\$96.00	T-Matic Connector	All 45 Light Series (45-xxxxCL)	Zinc plated steel	n/a	10	PDF	
** 151243		\$59.00	Automatic Connector		Steel			PDF	
** 151244		\$11.00	Automatic Butt Connector		PDF				
151245		\$11.50	Milling Connector	All 45 Series	Zinc plated steel	n/a	1	PDF	
151248		\$18.00	Connecting Strip					PDF	
162892		\$13.00	Direct Connector		Steel		Fasteners included	PDF	
162962		\$12.50	Miter Connector				M10-1.25 x 8mm set screw (4) included	PDF	

*T-Slot Nut also required.

** Does not fit 45 standard series (45-xxxxC)

FATH[®] T-Slotted Rail Accessories

Connecting Components - Continued

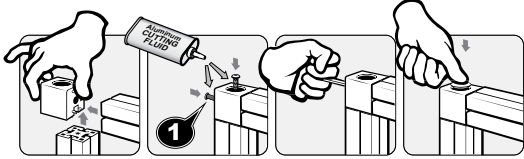
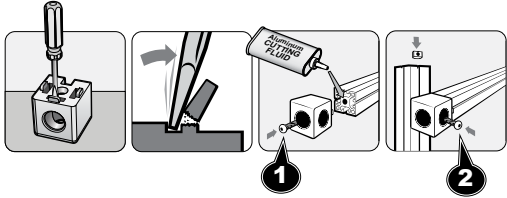
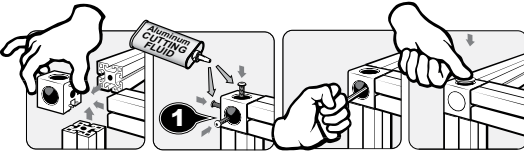
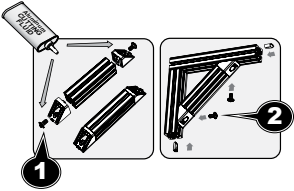
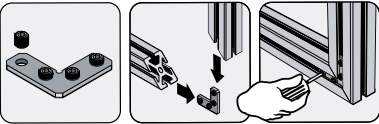
Connecting Components Installation	
Core Hole Installation	T-Slot Installation
2D Cube Connector	
	
3D Cube Connector	
	n/a
Angle Connector	
	
Miter Connector	
	

FATH® T-Slotted Rail Accessories

Connecting Components - Continued

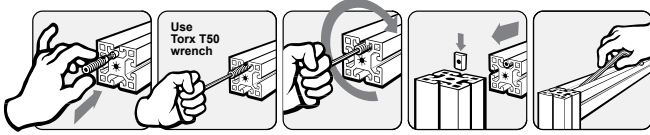
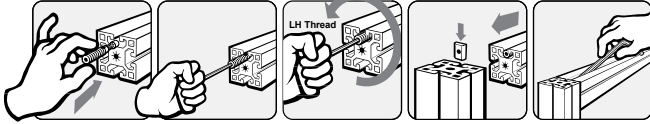
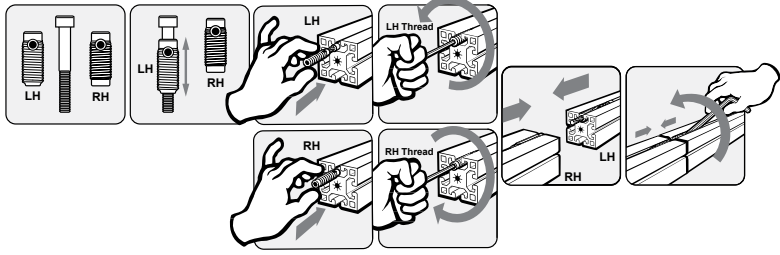
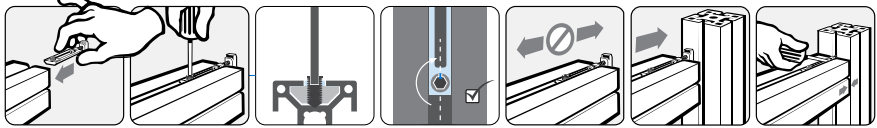
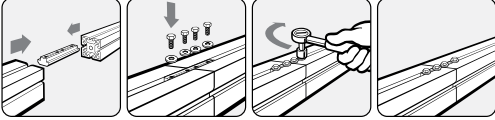
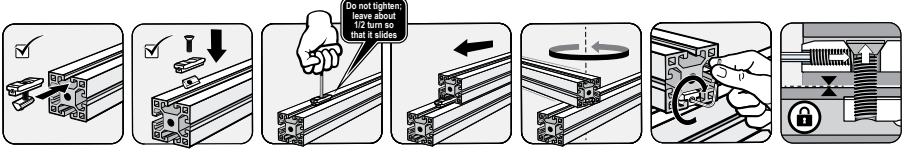
Connecting Components Installation	
T-Slot Installation	
T-matic Connector	
Automatic Connector	
Automatic Butt Connector	
Milling Connector	
Connecting Strip	
Direct Connector	
Miter Connector	