

# Heavy Duty Incremental Encoders (Metric Dimension Encoders)

## TRD-GK series

### Features

A heavy duty encoder is the most rugged encoder you can buy. Top-of-the-line bearings allow a service life of 12 billion revolutions. Features include:

- 10 mm solid shaft
- Rugged body with 78 mm diameter and 60 mm depth
- Splash-proof IP65 rating
- Incremental operation from 30 pulses per revolution to 5,000 pulses per revolution
- 100 kHz maximum response frequency
- 10-30 VDC, Totem-pole output



**Solid-shaft (TRD-GK) model**

Heavy Duty Standard Shaft Incremental Encoders					
Model	Price	Pulses per Revolution	Input Voltage	Output	Body Diameter
<a href="#">TRD-GK30-RZD</a>	\$319.00	30	10-30 VDC	Totem-pole (sink/source)	78mm
<a href="#">TRD-GK100-RZD</a>	\$319.00	100			
<a href="#">TRD-GK120-RZD</a>	\$319.00	120			
<a href="#">TRD-GK200-RZD</a>	\$319.00	200			
<a href="#">TRD-GK240-RZD</a>	\$319.00	240			
<a href="#">TRD-GK250-RZD</a>	\$319.00	250			
<a href="#">TRD-GK300-RZD</a>	\$319.00	300			
<a href="#">TRD-GK360-RZD</a>	\$319.00	360			
<a href="#">TRD-GK400-RZD</a>	\$319.00	400			
<a href="#">TRD-GK500-RZD</a>	\$366.00	500			
<a href="#">TRD-GK600-RZD</a>	\$366.00	600			
<a href="#">TRD-GK800-RZD</a>	Retired	800			
<a href="#">TRD-GK1000-RZD</a>	\$366.00	1000			
<a href="#">TRD-GK1200-RZD</a>	\$366.00	1000			
<a href="#">TRD-GK1500-RZD</a>	Retired	1500			
<a href="#">TRD-GK1800-RZD</a>	Retired	1800			
<a href="#">TRD-GK2000-RZD</a>	\$437.00	2000			
<a href="#">TRD-GK2500-RZD</a>	\$519.00	2500			
<a href="#">TRD-GK3600-RZD</a>	\$579.00	3600			
<a href="#">TRD-GK5000-RZD</a>	\$579.00	5000			

Electrical Specifications		
<b>Model</b>	<b>TRD-GKxxxx-RZD</b>	
<b>Power Supply</b>	<b>Operating Voltage</b>	10–30 VDC (nominal) * Range: 9.7–30.9 VDC
	<b>Allowable Ripple</b>	3% rms max.
	<b>Current Consumption</b>	At less than 16VDC: 50 mA max. / at 16VDC or more: 70mA max.
<b>Output Waveform</b>	<b>Output Signal</b>	Quadrature + home position
	<b>Duty Ratio</b>	50% ±25%
	<b>Max. Frequency Response</b>	100kHz max.
	<b>Operating Speed</b>	(max response frequency / resolution) x 60
	<b>Signal Width at Home Position</b>	At 400P or less: 25 to 150%; at 500P or more: 1° at 30'
	<b>Rise/Fall Time</b>	2µs max. (when cable length is 2m or less)
<b>Output</b>	<b>Output Type</b>	Totem-pole
	<b>Current: Outflow: H</b>	30mA max.
	<b>Voltage: H</b>	(power source voltage - 4V) min.
	<b>Voltage: L</b>	2V max.
	<b>Load Power Voltage</b>	35VDC max.
* To be supplied by Class II source		
Mechanical Specifications		
<b>Starting Torque</b>	Max. 0.1 N·m (0.07 ft·lbs) max. at 20°C (68°F)	
<b>Max. Allowable Shaft Load</b>	Radial: 100N (22.48 lbs) Axial: 50N (11.24 lbs)	
<b>Max. Allowable Speed</b>	5,000 rpm	
<b>Service Life of Bearing</b>	12 billion revolutions (at max. allowable speed)	
<b>Wire Size</b>	AWG24	
<b>Weight</b>	Approx. 600g (21.16 oz) with 2m cable	
Environmental Specifications		
<b>Ambient Temperature</b>	-10 to 70 °C [14 to 158 °F]	
<b>Storage Temperature</b>	-25 to 85 °C [-13 to 185 °F]	
<b>Operating Humidity</b>	35–85% RH (with no condensation)	
<b>Insulation Resistance</b>	50MΩ min.	
<b>Vibration Resistance</b>	At 500P or less: Durable for one hour along three axes at 10 to 55 Hz with 0.75 mm amplitude At 600P or more: Durable for one hour along three axes at 10 to 55 Hz with 0.35 mm amplitude	
<b>Shock Resistance</b>	At 500P or less: 11 ms with 980 m/s <sup>2</sup> applied three times along three axes At 600P or more: 11 ms with 294 m/s <sup>2</sup> applied three times along three axes	
<b>Protection</b>	IP65	

# Heavy Duty Incremental Encoders (Metric Dimension Encoders)

## TRD-GK series

### Accessories

#### Couplings

For encoders with a solid shaft, please select a coupling that fits your encoder. All couplings are in stock, ready to ship.

See the "Encoder Couplings" section for more information.

#### Mounting Brackets

Mounting brackets for all TRD-GK encoders.

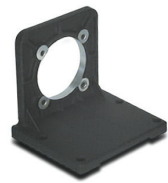

RT-11D

• \$33.00

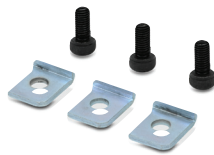
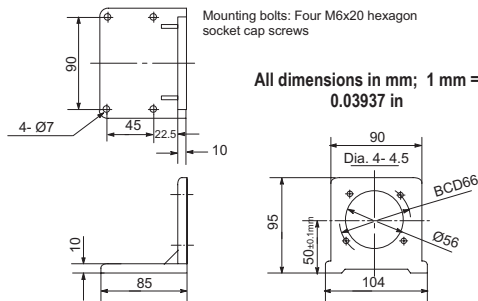

KM-9D

• \$8.00

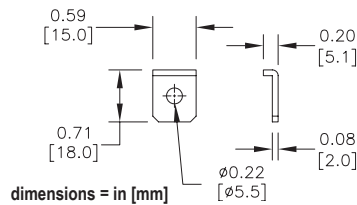

## Dimensions

### External dimensions

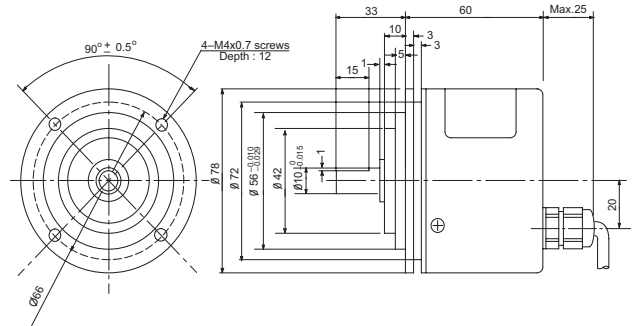

All dimensions in mm; 1 mm = 0.03937 in

### Servo mounting

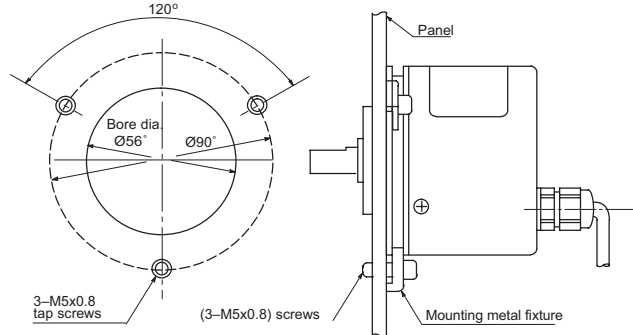

All dimensions in mm; 1 mm = 0.03937 in

## Wiring diagram

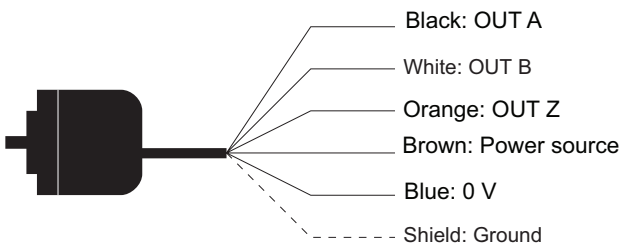

Cable shield is not connected to the encoder body; enclosure is grounded through the 0V wire.

## How to read the timing charts

### Totem Pole Models

Out A and Out B are 90 degrees out of phase. Like any quadrature encoder, four unique logic states are created internally to the encoder. This is based on the rising edge to rising edge (one cycle) on channel A or B that indicates one set of bars on the internal encoder disk has passed by the optical sensor.

OUT Z is the absolute reference added to an incremental encoder and is also known as home position. It signifies a full rotation of the encoder shaft.

## Channel timing chart

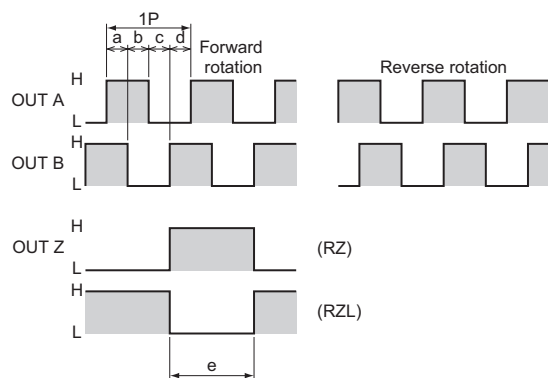

a, b, c, d = (1/4 ± 1/8) P  
e: 400 P or less: 25 to 150%  
500 P or more: 1 ± 30%  
(At 1,800, 3,600, 5000 pulses only: 50 to 150%)

OUT Z generates home position in both directions.

# Encoder Accessories – Couplings

## Encoder Couplings

Couplings provide a connection between solid-shaft encoders and solid shafts. We offer aluminum, fiberglass, and polymer couplings for metric, S.A.E. and metric-to-S.A.E. applications.

Misalignment compensation

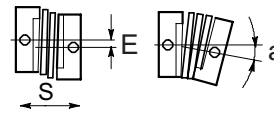

Couplings Selection Guide and Dimensions																
Type	Part Number	Price	Applicable Encoders (shaft size)	Shaft Diameter		D	L	F	C	M	a	E	S	Working Torque (N·m)	Torsional Rigidity	Material
				d1	d2	( mm [in] )					max					
				( mm [in] )												
Fiberglass (metric)	<a href="#">GJ-4D</a>	\$12.00	TRD-MX (4mm)	4mm	4mm	13 [0.51]	21 [0.83]	5.3 [0.21]	3 [0.12]	M3 set screw	5°	0.4 [0.02]	0.4 [0.02]	0.6 N·m	6 N·m/rad	Glass-fiber reinforced resin
	<a href="#">GJ-6D</a>	\$9.25	TRD-S/SR (6mm)	6mm	6mm	15 [0.59]	22 [0.87]	5.2 [0.20]	3 [0.12]	M3 set screw	6°	0.5 [0.02]	0.12 [0.005]	0.8 N·m	10 N·m/rad	
	<a href="#">GJ-8D</a>	\$11.00	TRD-N/NA (8mm)	8mm	8mm	19 [0.75]	24 [0.94]	6.8 [0.27]	3.5 [0.14]	M4 set screw	5°	0.5 [0.02]	0.4 [0.016]	1.5 N·m	20 N·m/rad	
	<a href="#">GJ-10D</a>	\$12.00	TRD-GK (10 mm)	10 mm	10 mm	22 [0.87]	26 [1.02]	7.1 [0.28]	4 [0.16]	M4 set screw	5°	0.5 [0.02]	0.12 [0.005]	2.0 N·m	32 N·m/rad	
Fiberglass (SAE)	<a href="#">GJ-635D</a>	\$22.00	TRDA-2E (0.25 in)	0.25 in	0.25 in	15 [0.59]	22 [0.87]	5.2 [0.20]	3 [0.12]	M3 set screw	5°	0.5 [0.02]	0.12 [0.005]	0.8 N·m	10 N·m/rad	Glass-fiber reinforced resin
	<a href="#">GJK-953D</a>	\$27.00	TRDA-20/25 (0.375 in)	0.375 in	0.375 in	25 [0.98]	32 [1.26]	7.3 [0.29]	3.5 [0.14]	M4 set screw	5°	0.5 [0.02]	0.12 [0.005]	2.0 N·m	32 N·m/rad	
Polymer (SAE)	<a href="#">STP-MTRA-SC-1412</a>	\$22.50	TRDA-2E (0.25 in)	0.25 in	0.50 in	25 [0.98]	38 [1.50]	9.9 [0.39]	5.4 [0.21]	M3 cap screw	5°	0.3 [0.01]	0.12 [0.005]	3.7 N·m	0.36 °/lb·in	Engineered polymer
	<a href="#">STP-MTRA-SC-3812</a>	\$22.50	TRDA-20/25 (0.375 in)	0.375 in	0.50 in	25 [0.98]	38 [1.50]	9.9 [0.39]	5.4 [0.21]	M3 cap screw	5°	0.3 [0.01]	0.12 [0.005]	3.7 N·m	0.36 °/lb·in	
Aluminum (metric)	<a href="#">ARM-075-5-4D</a>	\$51.50	TRD-MX (4mm)	4mm	5mm	19.1 [0.75]	19.1 [0.75]	4.6 [0.18]	2.4 [0.09]	M3 set screw	5°	0.25 [0.01]	0.25 [0.01]	2.3 N·m	8.2 N·m/rad	Aluminum alloy
	<a href="#">RU-075D</a>	\$58.00	TRD-S/SR (6mm)	6mm	6mm	19.1 [0.75]	19.1 [0.75]	4.6 [0.18]	2.4 [0.09]	M3 set screw	5°	0.25 [0.01]	0.12 [0.005]	1.0 N·m	8.2 N·m/rad	
	<a href="#">JU-100D</a>	\$51.50	TRD-N/NA (8mm)	8mm	8mm	25.4 [1.00]	25.4 [1.00]	6.6 [0.26]	3.8 [0.15]	M5 set screw	5°	0.25 [0.01]	0.25 [0.01]	1.6 N·m	14.3 N·m/rad	
	<a href="#">RU-100D</a>	\$60.00	TRD-GK (10 mm)	10 mm	10 mm	25.4 [1.00]	25.4 [1.00]	6.6 [0.26]	3.8 [0.15]	M5 set screw	5°	0.25 [0.01]	0.12 [0.005]	1.6 N·m	14.3 N·m/rad	
Aluminum (metric-to-SAE)	<a href="#">ML13P-4-476D</a>	\$51.50	TRD-MX (4mm)	4mm	0.1875 in	13 [0.51]	19 [0.75]	5.5 [0.22]	2.5 [0.10]	M2 set screw	5°	0.4 [0.02]	0.2 [0.01]	0.25 N·m	44 N·m/rad	Aluminum alloy (Bent plate: Polyimide)
	<a href="#">ML16P-4-635D</a>	\$51.50	TRD-MX (4mm) TRDA-2E (0.25 in)	4mm	0.25 in	16 [0.63]	23 [0.91]	7 [0.28]	3 [0.12]	M3 set screw	5°	0.6 [0.02]	0.3 [0.01]	0.4 N·m	70 N·m/rad	
	<a href="#">MCGL16-6-635</a>	\$33.00	TRD-S/SR (6mm) TRDA-2E (0.25 in)	6mm	0.25 in	16 [0.63]	23.2 [0.91]	7 [0.28]	3 [0.12]	M3 set screw	3.5°	0.3 [0.01]	0.3 [0.01]	0.4 N·m	70 N·m/rad	
	<a href="#">MCGL20-8-635</a>	\$43.00	TRD-N/NA (8mm) TRDA-2E (0.25 in)	8mm	0.25 in	20 [0.79]	26 [1.02]	7.5 [0.30]	3.7 [0.15]	M3 set screw	3.5°	0.3 [0.01]	0.4 [0.02]	0.6 N·m	130 N·m/rad	
	<a href="#">MCGL20-8-952</a>	\$44.00	TRD-N/NA (8mm) TRDA-20/25 (0.375 in)	8mm	0.375 in	20 [0.79]	26 [1.02]	7.5 [0.30]	3.7 [0.15]	M3 set screw	3.5°	0.3 [0.01]	0.4 [0.02]	0.6 N·m	130 N·m/rad	
	<a href="#">MCGL25-10-635</a>	\$54.00	TRD-GK (10 mm) TRDA-2E (0.25 in)	10 mm	0.25 in	25 [0.98]	30.2 [1.19]	9 [0.35]	4 [0.16]	M4 set screw	3.5°	0.3 [0.01]	0.5 [0.02]	1.4 N·m	240 N·m/rad	
	<a href="#">MCGL25-10-952</a>	\$55.00	TRD-GK (10 mm) TRDA-20/25 (0.375 in)	10 mm	0.375 in	25 [0.98]	30.2 [1.19]	9 [0.35]	4 [0.16]	M4 set screw	3.5°	0.3 [0.01]	0.5 [0.02]	1.4 N·m	240 N·m/rad	
Aluminum (SAE)	<a href="#">ARM-075-635-635D</a>	\$52.00	TRDA-2E (0.25 in)	0.25 in	0.25 in	19.1 [0.75]	19.1 [0.75]	4.6 [0.18]	2.4 [0.09]	M3 set screw	5°	0.25 [0.01]	0.25 [0.01]	1.0 N·m	8.2 N·m/rad	Aluminum alloy
	<a href="#">ARM-100-9525-9525D</a>	\$50.00	TRDA-20/25 (0.375 in)	0.375 in	0.375 in	25.4 [1.00]	25.4 [1.00]	6.6 [0.26]	3.8 [0.15]	M5 set screw	5°	0.25 [0.01]	0.25 [0.01]	1.6 N·m	14.3 N·m/rad	

\* mm ÷ 25.4 = inches

# Encoder Accessories – Couplings

## Encoder Couplings – Dimensions

**GJ-xxD Fiberglass Couplings (metric) & GJx-xxxD Fiberglass Couplings (SAE)**

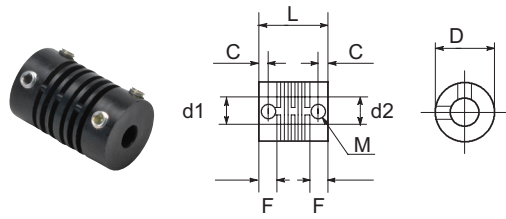

**STP-MTRA-SC-xxxx Polymer Couplings**

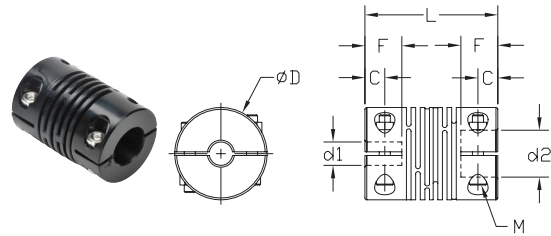

**ARM-xxxxxxD Aluminum Couplings (metric & SAE)**

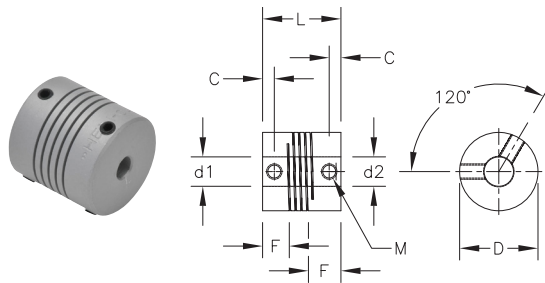

**MCGLxx Aluminum Couplings & ML1xP-4-xxxD Aluminum Couplings**

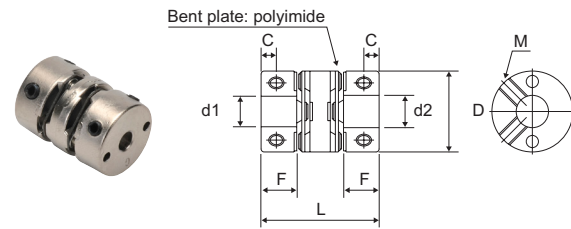

**RU-075D, RU-100D, and JU-100D Aluminum Couplings**

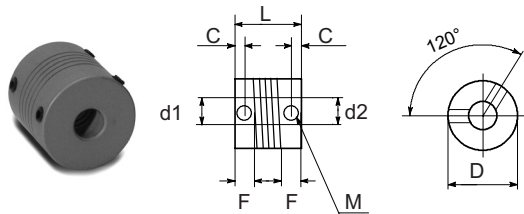

# Great Encoder Selection at Great Prices

**JTEK**



Kit Encoder AMT



Light-duty TRD-SR



Medium Duty TRDA-25 (w/MS connector)



Medium Duty TRD-N



Medium Duty TRD-NH



Heavy-duty TRD-GK

		Duty	Family	Size	Encoder Diameter	Shaft Diameter	Solid or Hollow Shaft	Operating Voltage (VDC) and Electrical Output*	IP Rating	Max Radial Load (N)	Max Axial Load (N)	Available Resolutions (PPR)
Incremental	Modular/Kit	AMT (CUI Devices)	11, 15	28mm, 42mm	2/3/4/5/6/8/9/10/11/12/13/14mm, 3/16", 1/4", 3/8", 1/2", 5/8"	hollow	5V Line Driver or 5V P/P	IP20	NA**	NA**	Programmable Up to 4096	
		STP-MTRA-ENC	12	31mm	5mm, 1/4", 3/8"	hollow	5V Line Driver or 5V P/P	IP20	NA**	NA**	400, 1000	
	Light Duty	TRD-SR	15	38 or 40mm	6mm	solid	5V Line Driver or 5-26V OC	IP50 or IP65	20	10	100, 200, 360, 500, 600, 1000, 1024, 2000, 2500	
		TRD-SHR	15	38 or 40mm	8mm	hollow	5V Line Driver or 5-26V OC	IP50 or IP65	20	10	100, 200, 360, 500, 600, 1000, 1024, 2000, 2500	
	Medium Duty	TRDA-20	20	2"	3/8"	solid	5V Line Driver or 5-30V P/P	IP50	50	30	100, 360, 500, 1000, 1024, 2500	
		TRDA-25	25 (w/size 20 body)	2.5" flange (w/ 2.0" body)	3/8"	solid	5V Line Driver or 5-30V P/P	IP65	50	30	100, 360, 500, 1000, 1024, 2500	
		TRD-N	20	50mm	8mm	solid	5V Line Driver or 5-30V P/P	IP65	50	30	3, 4, 5, 10, 30, 40, 50, 60, 100, 120, 200, 240, 250, 300, 360, 400, 480, 500, 600, 750, 1000, 1024, 1200, 2000, 2500	
		TRD-NH	20	50mm	8mm	hollow	5V Line Driver or 5-30V P/P	IP65	50	30	3, 4, 5, 10, 30, 40, 50, 60, 100, 120, 200, 240, 250, 300, 360, 400, 480, 500, 600, 750, 1000, 1024, 1200, 2000, 2500	
	Heavy Duty	TRD-GK	30	78mm	10mm	solid	10-30V P/P	IP65	100	50	30, 100, 120, 200, 240, 250, 300, 360, 400, 500, 600, 1000, 1200, 2000, 2500, 3600, 5000	
	Medium Duty Absolute	TRD-NA	20	50mm	8mm	solid	10-30V OC	IP65	50	30	32, 64, 128, 180, 256, 360, 512, 720, 1024 (grey code)	

Modular/Kit and TRDA-25 encoders have connectors and require separate cables. All other encoders feature an integral 2m cable.

\*Operating Voltage and Electrical Output:

- LD = Line Driver (all Line Drivers require 5VDC supply)
- OC = NPN Open Collector (at Operating Voltage)
- P/P = Push Pull or Totem Pole (at Operating Voltage)

\*\*Modular/Kit encoders are direct mount, there are no load ratings.

## Accessories

### Couplings

A variety of couplings - metric-to-metric, inch-to-inch (SAE - SAE), and metric-to-inch are in stock, ready to ship.



### Flanges

A collection of flanges that ease encoder mounting. Several models are available with round flanges, square flanges and miscellaneous mounting options.



### Mounting brackets

Simplify your installation with a ready-to-use right-angle mounting bracket for light, medium and heavy-duty encoders



### Cables

For encoders that require a connector cable, we have cables in stock, priced right and ready to ship.

