

# Enclosure Heating and Heater Selection

## Why Heat an Enclosure?

Today's miniaturization of enclosure components results in high packing densities, which in turn results in higher temperatures within the enclosure. These high temperatures are harmful to electronic components. In response, cooling systems have become standard in many applications. However, just as critical and widely underestimated, are failures caused by the formation of moisture.

Under certain climatic conditions, moisture can build up not only in outdoor or poorly insulated enclosures, but also in highly protected and well-sealed enclosures.

## Moisture and Failure

Moisture, especially when combined with aggressive gases and dust, causes atmospheric corrosion and can result in the failure of components such as circuit breakers, busbars, relays, integrated circuit boards and transformers. The greatest danger lies in conditions where electronic equipment is exposed to relatively high air humidity or extreme variations in temperature, such as day-and-night operation or outdoor installation. Failure of components in such cases is usually caused by changing contact resistances, flashovers, creepage currents or reduced insulation properties.

## Eliminate Moisture

Moisture and corrosion will remain low if relative air humidity stays below 60%. However, relative humidity above 65% will significantly increase moisture and corrosion problems. This can be prevented by keeping the environment inside an enclosure at a temperature as little as 9°F (5°C) higher than that of the ambient air. Constant temperatures are a necessity to guarantee optimal operating conditions. Continuous temperature changes not only create condensation but they reduce the life expectancy of electronic components significantly. Electronic components can be protected by cooling during the day and heating at night.

## Thermal Management

Modern enclosure heaters are designed to protect against condensation. They heat the air inside enclosures, preventing water vapor from condensing on components while providing the greatest possible air circulation and low energy consumption.

Other heating element technology improvements include:

- Longer operating life
- Greater energy efficiencies
- Quick wiring options
- Easier mounting
- Fan heaters should be considered for larger enclosures to ensure that the entire enclosure is heated uniformly

## Heater Location

Ideally, most heaters will perform optimally when mounted near the bottom of an enclosure and used in conjunction with a control device, thermostat, and/or hygostat. The control device may be a separate device, or it may be integral to the heater. With the controller located in an area of the cabinet that is representative of the average temperature or humidity requirement, the heater should then be placed in a position near the bottom of the enclosure. If a separate control device is used, the heater should not be located directly beneath the controller to ensure that the controller is not influenced by direct heat from the heater.

## Heater Calculation

Follow Steps 1-5 to determine the heating requirement of an enclosure (US units - left column, metric - right)

STEP 1: Determine the Surface Area (A) of your enclosure which is exposed to open air.

Enclosure Dimensions:

height = \_\_\_\_\_ feet \_\_\_\_\_ meters

width = \_\_\_\_\_ feet \_\_\_\_\_ meters

depth = \_\_\_\_\_ feet \_\_\_\_\_ meters

Choose Mounting Option from next page, and calculate the surface area as indicated

A = \_\_\_\_\_ ft<sup>2</sup> or \_\_\_\_\_ m<sup>2</sup>

STEP 2: Choose the Heat Transmission Coefficient (k) for your enclosure's material of construction.

painted steel = 0.511 W/(ft<sup>2</sup>K) 5.5 W/(m<sup>2</sup>K)

stainless steel = 0.344 W/(ft<sup>2</sup>K) 3.7 W/(m<sup>2</sup>K)

aluminum = 1.115 W/(ft<sup>2</sup>K) 12 W/(m<sup>2</sup>K)

plastic or insulated stainless = 0.325 W/(ft<sup>2</sup>K) 3.5 W/(m<sup>2</sup>K)

k = \_\_\_\_\_ W/(ft<sup>2</sup>K) or \_\_\_\_\_ W/(m<sup>2</sup>K)

STEP 3: Determine the Temperature Differential (ΔT).

A. Desired enclosure interior temp. = \_\_\_\_°F \_\_\_\_°C

B. Lowest ambient (outside) temp. = \_\_\_\_°F \_\_\_\_°C

Subtract B from A = Temp. diff. (ΔT) = \_\_\_\_°F \_\_\_\_°C

For these calculations, ΔT must be in° Kelvin (K). Therefore, divide ΔT (°F) by 1.8. ΔT = \_\_\_\_\_ K

STEP 4: Determine Heating Power (PV), if any (generated from existing components, i.e. transformer).

PV = \_\_\_\_\_ W or \_\_\_\_\_ W

STEP 5: Calculate the Required Heating Power (PH) for your enclosure based on the above values.

If enclosure is located inside:

PH = (A x k x ΔT) - PV = \_\_\_\_\_ W

If enclosure is located outside:

PH = 2 x (A x k x ΔT) - PV = \_\_\_\_\_ W

# Enclosure Mounting Types and Surface Area Calculations

## 1. Free-Standing

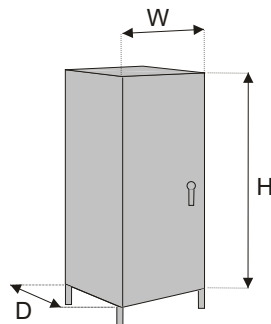

$$\text{Area (A)} = 1.8\text{ft}^2 [0.05\text{m}^2] (H \times W) + 1.8 (H \times D) + 1.8\text{ft}^2 [0.05\text{m}^2] (W \times D)$$

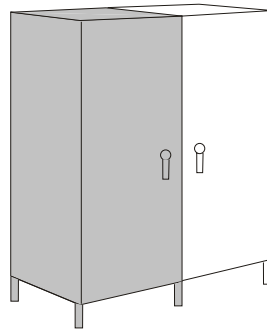

$$\text{Area (A)} = 1.8\text{ft}^2 [0.05\text{m}^2] (H \times W) + 1.4 (H \times D) + 1.8\text{ft}^2 [0.05\text{m}^2] (W \times D)$$

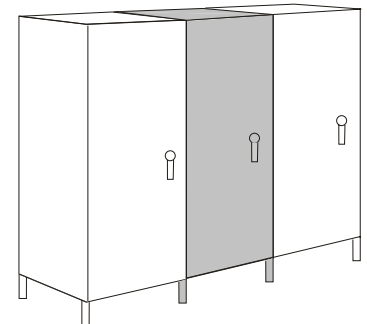

$$\text{Area (A)} = 1.8\text{ft}^2 [0.05\text{m}^2] (H \times W) + (H \times D) + 1.8\text{ft}^2 [0.05\text{m}^2] (W \times D)$$

## 2. Wall-Mounted

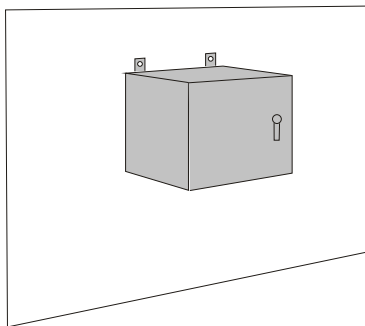

$$\text{Area (A)} = 1.4\text{ft}^2 [0.04\text{m}^2] (H \times W) + 1.8 (H \times D) + 1.8\text{ft}^2 [0.05\text{m}^2] (W \times D)$$

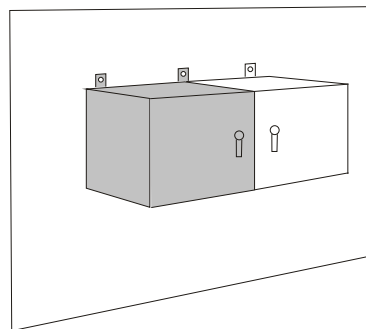

$$\text{Area (A)} = 1.4\text{ft}^2 [0.04\text{m}^2] (H \times W) + 1.4 (H \times D) + 1.8\text{ft}^2 [0.05\text{m}^2] (W \times D)$$

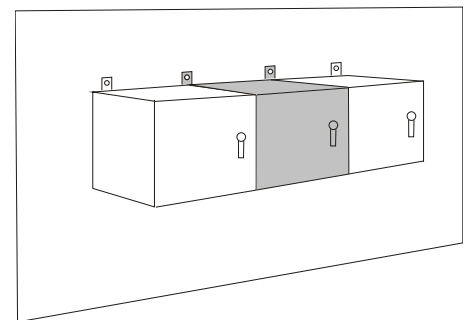

$$\text{Area (A)} = 1.4\text{ft}^2 [0.04\text{m}^2] (H \times W) + (H \times D) + 1.8\text{ft}^2 [0.05\text{m}^2] (W \times D)$$

## 3. Ground

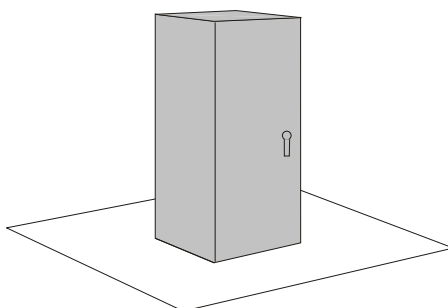

$$\text{Area (A)} = 1.8\text{ft}^2 [0.05\text{m}^2] (H \times W) + 1.8 (H \times D) + 1.4\text{ft}^2 [0.04\text{m}^2] (W \times D)$$

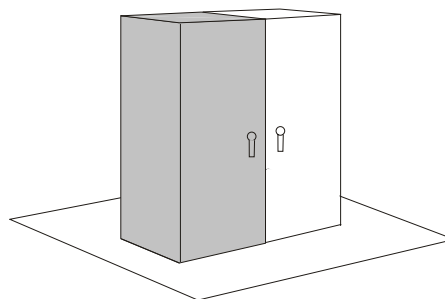

$$\text{Area (A)} = 1.8\text{ft}^2 [0.05\text{m}^2] (H \times W) + 1.4 (H \times D) + 1.4\text{ft}^2 [0.04\text{m}^2] (W \times D)$$

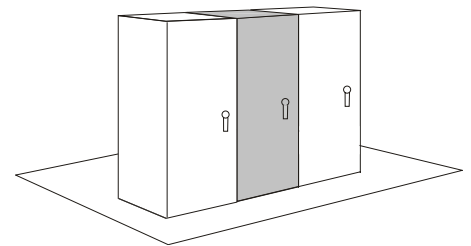

$$\text{Area (A)} = 1.8\text{ft}^2 [0.05\text{m}^2] (H \times W) + (H \times D) + 1.4\text{ft}^2 [0.04\text{m}^2] (W \times D)$$

## 4. Ground and Wall

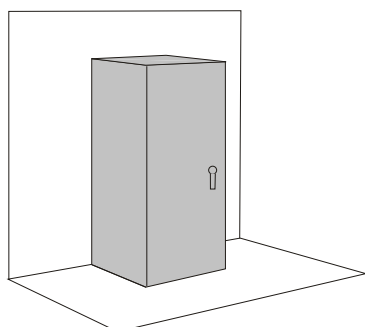

$$\text{Area (A)} = 1.4\text{ft}^2 [0.04\text{m}^2] (H \times W) + 1.8 (H \times D) + 1.4\text{ft}^2 [0.04\text{m}^2] (W \times D)$$

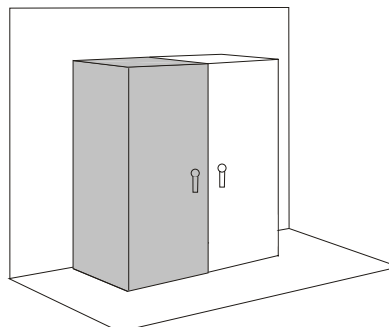

$$\text{Area (A)} = 1.4\text{ft}^2 [0.04\text{m}^2] (H \times W) + 1.4 (H \times D) + 1.4\text{ft}^2 [0.04\text{m}^2] (W \times D)$$

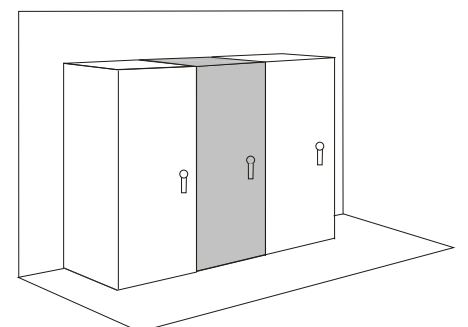

$$\text{Area (A)} = 1.4\text{ft}^2 [0.04\text{m}^2] (H \times W) + (H \times D) + 1.4\text{ft}^2 [0.04\text{m}^2] (W \times D)$$

# 10W to 150W Touch-Safe PTC Heaters



060000-00, 060100-00 and 060200-00



060300-00, 060400-00 and 060401-00



060010-00, 060110-00, and 060210-00

## Applications

These touch-safe positive temperature coefficient heaters are for use in enclosures. The design of the heater utilizes natural convection, which results in a circulating current of warm air. The heater's design minimizes surface temperatures on the accessible side surfaces of the housing. Models 060010-00, 060110-00, and 060210-00 include a plug-in thermostat and require no additional wiring.

## Features

- Compact heater
- Low surface temperature
- Wide voltage range
- Double insulated protection
- DIN rail mounting



10W to 150W Touch-Safe PTC Heaters Specifications		
<b>Heating Element</b>		PTC Resistor - Temperature limiting
<b>Connection</b>	060300-00 060400-00 060401-00	2-pole terminal, 14 AWG [2.5mm] max. solid wire or stranded wire with wire end ferrules, 0.8 N·m max. clamping torque
	060000-00 060010-00 060100-00 060110-00 060200-00 060210-00	4-pole terminal, 14 AWG [2.5 mm <sup>2</sup> ], 0.8 N·m max. clamping torque
<b>Housing</b>		Plastic, UL 94V-0, black
<b>Mounting</b>		Clip for 35mm DIN rail, EN 60715
<b>Mounting Position</b>		Vertical only (exhaust up)
<b>Recommended Mounting Distance</b>		Sides: 0.79in [20 mm] Bottom/above: 1.97in [50 mm]
<b>Operating/Storage Temperature</b>	060000-00 060000-00 060200-00 060300-00 060400-00 060401-00	-49 to 158°F [-45 to 70°C]
	060010-00 060110-00	-40 to 158°F [-40 to 70°C]
	060210-00	-49 to 158°F [-45 to 70°C]
<b>Operating / Storage Humidity</b>		Max. 90% RH (non-condensing)
<b>Protection Class</b>		II (double insulated)
<b>Protection Type</b>		IP20
<b>Approvals</b>		CE, UL Recognized File No. E150057 (except 060401-00), RoHS 2 compliant

Note: To obtain the most current agency approval information, see the Agency Approval Checklist section on the specific part number's web page at [www.automationdirect.com](http://www.automationdirect.com)

10W to 150W Touch-Safe PTC Heaters								
Part Number	Price	Heating Capacity <sup>1</sup>	Operating Voltage <sup>2</sup>	Max. current (inrush)	Air Outlet Temp <sup>3</sup>	Switch-off Temp <sup>4</sup>	Switch-on Temp <sup>4</sup>	Weight (approx.)
<a href="#">060401-00</a>	\$36.50	10W	12-30V AC/DC	8.0 A	187°F [86°C]	—	—	5.0 oz [140g]
<a href="#">060400-00</a>	\$33.50		120-240V AC/DC	1.0 A				
<a href="#">060300-00</a>	\$38.00	20W	120-240V AC/DC	2.5 A	187°F [86°C]	—	—	6.1 oz [170g]
<a href="#">060000-00</a>	\$60.00	50W	120-240V AC/DC (min. 110V, max. 265V)	2.5 A	187°F [86°C]	—	—	10.4 oz [295g]
<a href="#">060010-00</a>	\$71.00		120-240V AC (min. 110V, max. 265V)	2.5 A				
<a href="#">060100-00</a>	\$87.00	100W	120-240V AC/DC (min. 110V, max. 265V)	4.5 A	248°F	—	—	10.6 oz [300g]
<a href="#">060110-00</a>	\$98.00		120-240V AC (min. 110V, max. 265V)	4.5 A	[120°C]			
<a href="#">060200-00</a>	\$100.00	150W	120-240V AC/DC (min. 110V, max. 265V)	8.0 A	293°F	—	—	15.5 oz [440g]
<a href="#">060210-00</a>	\$111.00		120-240V AC (min. 110V, max. 265V)	8.0 A	[145°C]			

Notes: 50, 100, 150W rating at 32°F [0°C] ambient temperature, 10, 20W rating at 68°F [20°C] ambient temperature  
 Operating with voltages below 140V AC/DC reduces heating performance by approx. 10% (min. 110V)  
 Measured 2" [50mm] above protective grill  
 Tolerance of ±9°F [±5K]

# 10W to 150W Touch-Safe PTC Heaters



## Dimensions

**060000-00, 060100-00 and 060200-00**

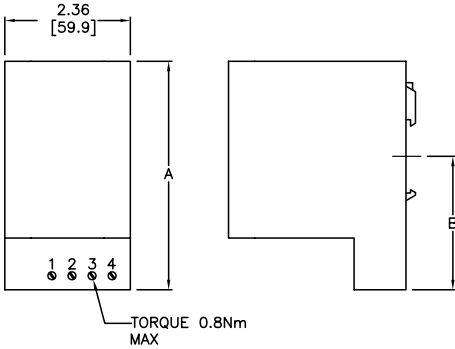

**060300-00, 060400-00 and 060401-00**

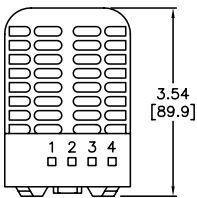
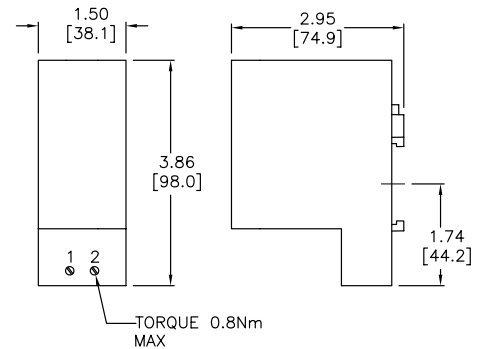
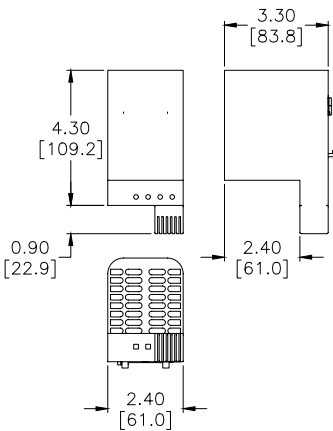

TABLE 1		
PART NUMBER	DIM A	DIM B
060000-00	4.30 [109.2]	2.51 [63.8]
060100-00	4.30 [109.2]	2.51 [63.8]
060200-00	5.90 [149.9]	4.07 [103.4]

Dimensions – Inches [mm]		
Part Numbers	DIM A	DIM B
<b>060000-00</b>	4.30 [109.2]	2.51 [63.8]
<b>060100-00</b>	4.30 [109.2]	2.51 [63.8]
<b>060200-00</b>	5.90 [149.9]	4.07 [103.4]

**060010-00 and 060110-00**



**060210-00**

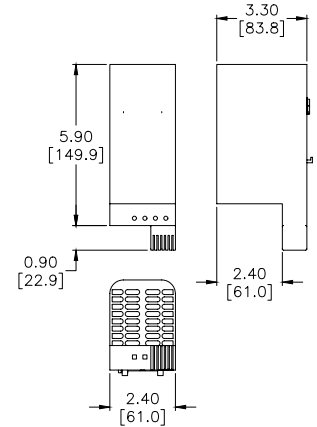

## Wiring Diagrams

**060000-00, 060100-00 and 060200-00**

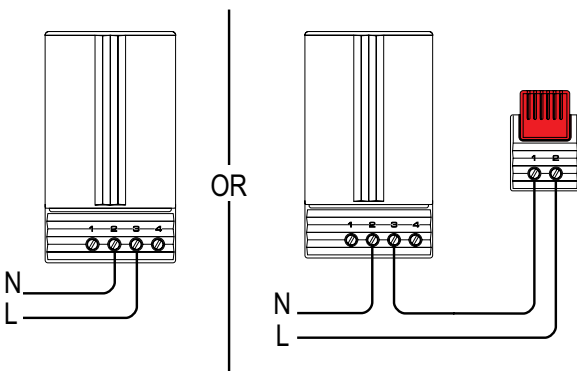

**060300-00, 060400-00 and 060401-00**

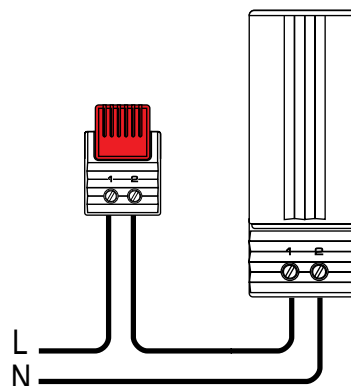

**060010-00, 060110-00 and 060210-00**

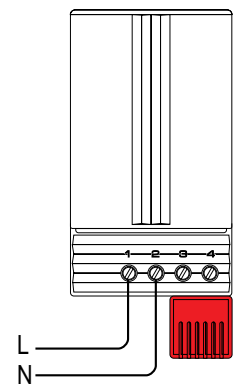

Note: When wiring 230 volt units for North American installations "L" (line) and "N" (neutral) will be used as "L1" (line1) "L2" (line2) respectively with no neutral connection.