

# Dual Element Time-Delay Class RK5 Fuses



ECNR40



ECNR70



ECNR150



ECSR5



ECSR100



ECSR200

These fuses are recommended for AC power distribution system mains, feeders and branch circuits having inductive loads (motors, transformers) or non-inductive loads (lighting, heating) where the available short-circuit current does not exceed 200,000 RMS symmetrical amperes. These dual element, time-delay fuses have minimum industry standard time-delay of 10 seconds at 5 times the fuse rating (8 sec. minimum for 250V, 30A and less). The time-delay characteristics of these fuses typically allows them to be sized closer to the running ampacity of inductive loads to reduce cost and provide improved overcurrent protection. These fuses will override normal equipment current surges to reduce unnecessary fuse openings. They are the most popular fuses used in the industry and the most economical for most applications, especially motors and transformers. They have moderate current limitation.

## ECNR/ECSR

### Features

- True dual - element construction allows sizing of 125% FLA for motor backup protection
- Superior overload and cycling capabilities
- Current limiting; provides component short circuit protection

### Applications

- Recommended for AC power distribution system mains, feeders, and branch circuits
- Protection of motors and motor branch circuits
- Protection of transformers and other inductive loads
- All general-purpose applications including lighting, heating and other non-inductive loads

## ECNR/ECSR

### Specifications

Voltage Rating:

- ECNR: 250 VAC
- ECSR: 600 VAC

Ampere Rating:

- ECNR: 1-600 Amps
- ECSR: 3-600 Amps

Interrupting Rating:

- 200,000 RMS Symmetrical Amps

Self-Certified DC Ratings:

- Voltage Rating:  
ECNR (1-200): 125 VDC  
ECNR (201-600): 250 VDC  
ECSR (3-600): 300 VDC

- Self-Certified Interrupting Rating:  
ECNR/ECSR 20,000 Amperes DC

Current Limiting: RK5 Fuse

### Agency Approvals

- UL Listed, Class RK5, Guide JDDZ, File E162363
- CSA Certified HRCI-R per C22.2, No. 248.12

CROSS REFERENCE				
VOLTS	EDISON	BUSSMANN	MERSEN GOULD	LITTELFUSE
250	ECNR	FRN-R	TR	FLNR
600	ECSR	FRS-R	TRS	FLSR

# Dual Element Time-Delay Class RK5 Fuses



ECNR Series 250V Dual-element Time-delay Fuses						
Part Number	AMP Rating	Rated Voltage	Pcs/Pkg	Package Weight	Price	
		AC Max				
<a href="#">ECNR1</a>	1	250V	10	0.30 lb	\$114.00	
<a href="#">ECNR2</a>	2				\$110.00	
<a href="#">ECNR3</a>	3				\$106.00	
<a href="#">ECNR5</a>	5				\$103.00	
<a href="#">ECNR8</a>	8				\$106.00	
<a href="#">ECNR10</a>	10				\$103.00	
<a href="#">ECNR15</a>	15		0.50 lb	\$81.00		
<a href="#">ECNR20</a>	20			\$81.00		
<a href="#">ECNR25</a>	25			\$81.00		
<a href="#">ECNR30</a>	30			\$81.00		
<a href="#">ECNR35</a>	35			1.00 lb	\$131.00	
<a href="#">ECNR40</a>	40				\$131.00	
<a href="#">ECNR45</a>	45		\$131.00			
<a href="#">ECNR50</a>	50		\$131.00			
<a href="#">ECNR60</a>	60		\$131.00			
<a href="#">ECNR70</a>	70		5		1.50 lb	\$152.00
<a href="#">ECNR80</a>	80			\$152.00		
<a href="#">ECNR90</a>	90			\$161.00		
<a href="#">ECNR100</a>	100			\$152.00		
<a href="#">ECNR125</a>	125			0.77 lb		\$76.00
<a href="#">ECNR150</a>	150					\$76.00
<a href="#">ECNR175</a>	175		\$76.00			
<a href="#">ECNR200</a>	200		1	1.52 lb	\$76.00	
<a href="#">ECNR225</a>	225				\$100.00	
<a href="#">ECNR250</a>	250				\$100.00	
<a href="#">ECNR300</a>	300				\$100.00	
<a href="#">ECNR350</a>	350				\$102.00	
<a href="#">ECNR400</a>	400				\$97.00	
<a href="#">ECNR450</a>	450		3.00 lb	\$162.00		
<a href="#">ECNR500</a>	500			\$162.00		
<a href="#">ECNR600</a>	600	\$162.00				

ECSR Series 600V Dual-element Time-delay Fuses							
Part Number	AMP Rating	Rated Voltage	Pcs/Pkg	Package Weight	Price		
		AC Max					
<a href="#">ECSR3</a>	3	600V	10	1.7 lb	\$188.00		
<a href="#">ECSR4</a>	4				\$188.00		
<a href="#">ECSR5</a>	5				\$188.00		
<a href="#">ECSR6</a>	6				\$188.00		
<a href="#">ECSR6-25</a>	6.25				\$196.00		
<a href="#">ECSR7</a>	7				\$200.00		
<a href="#">ECSR8</a>	8				\$188.00		
<a href="#">ECSR10</a>	10				\$188.00		
<a href="#">ECSR12</a>	12				\$188.00		
<a href="#">ECSR15</a>	15				\$167.00		
<a href="#">ECSR17-5</a>	17.5		\$167.00				
<a href="#">ECSR20</a>	20		\$167.00				
<a href="#">ECSR25</a>	25		\$167.00				
<a href="#">ECSR30</a>	30		\$167.00				
<a href="#">ECSR35</a>	35		3.00 lb	\$293.00			
<a href="#">ECSR40</a>	40			\$293.00			
<a href="#">ECSR45</a>	45			\$293.00			
<a href="#">ECSR50</a>	50			\$293.00			
<a href="#">ECSR60</a>	60			\$293.00			
<a href="#">ECSR70</a>	70			5	50.54 lb	\$315.00	
<a href="#">ECSR80</a>	80		\$315.00				
<a href="#">ECSR90</a>	90		\$315.00				
<a href="#">ECSR100</a>	100		\$315.00				
<a href="#">ECSR110</a>	110		1			1.00 lb	\$123.00
<a href="#">ECSR125</a>	125					1.22 lb	\$123.00
<a href="#">ECSR150</a>	150						\$123.00
<a href="#">ECSR175</a>	175						\$123.00
<a href="#">ECSR200</a>	200						\$123.00
<a href="#">ECSR225</a>	225						3.00 lb
<a href="#">ECSR250</a>	250		\$190.00				
<a href="#">ECSR300</a>	300	\$207.00					
<a href="#">ECSR350</a>	350	\$190.00					
<a href="#">ECSR400</a>	400	\$190.00					
<a href="#">ECSR450</a>	450	5.00 lb	\$278.00				
<a href="#">ECSR500</a>	500		\$278.00				
<a href="#">ECSR600</a>	600		\$278.00				

## ECNR/ECSR Dimensions

Ferrule Design – 1 through 60 Amperes

Knife Blade – 70 through 600 Amperes

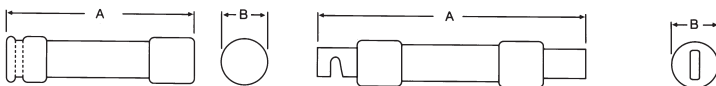

Dimensions inches (mm)							
Part Number	Amps	Overall Length	Max Diameter	Part Number	Amps	Overall Length	Max Diameter
		A	B			A	B
ECNR 250V	1-30	2 (50.8)	0.56 (14.2)	ECSR 600V	3-30	5 (127)	0.81 (20.6)
	35-60	3 (76.2)	0.81 (20.6)		35-60	5.5 (139.7)	1.06 (26.9)
	70-100	5.88 (149.4)	1.06 (26.9)		70-100	7.88 (200.2)	1.11 (28.2)
	110-200	7.13 (181.1)	1.56 (39.6)		110-200	9.63 (244.6)	1.61 (40.9)
	225-400	8.63 (219.2)	2.06 (52.3)		225-400	11.63 (295.4)	2.34 (59.4)
	450-600	10.38 (263.7)	2.59 (65.8)		450-600	13.38 (339.9)	2.88 (73.2)

# Dual Element Time-Delay Class RK5 Fuses



## ECNR Curves

AVERAGE TIME/CURRENT CURVES  
Cat No. ECNR (AMP) 250 VAC

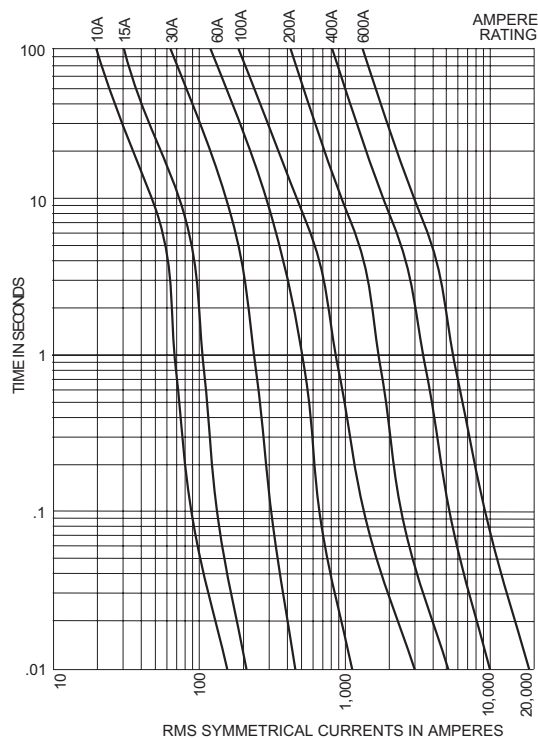
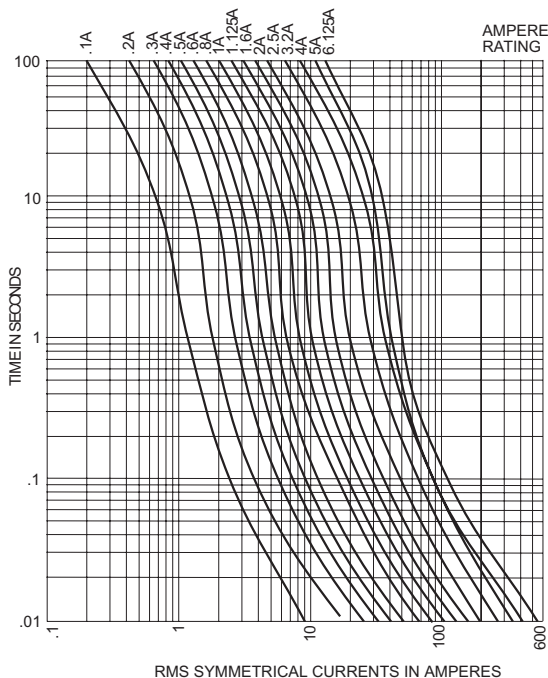

## ECSR Curves

AVERAGE TIME/CURRENT CURVES  
Cat No. ECSR (AMP) 600 VAC

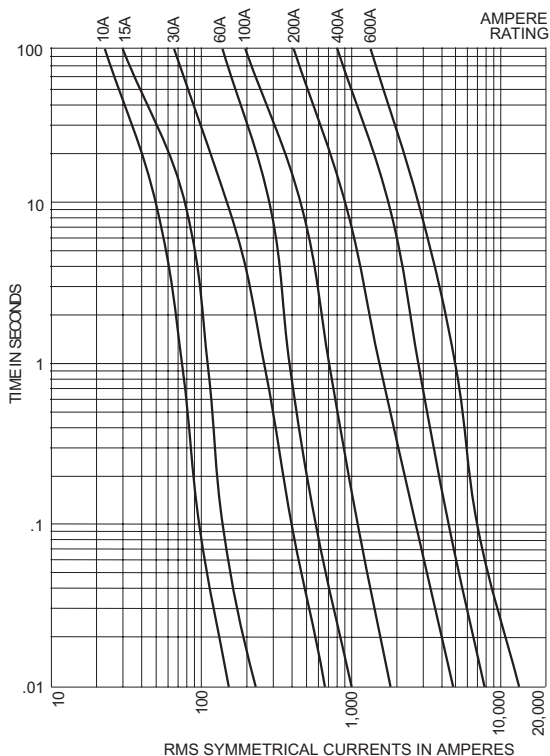
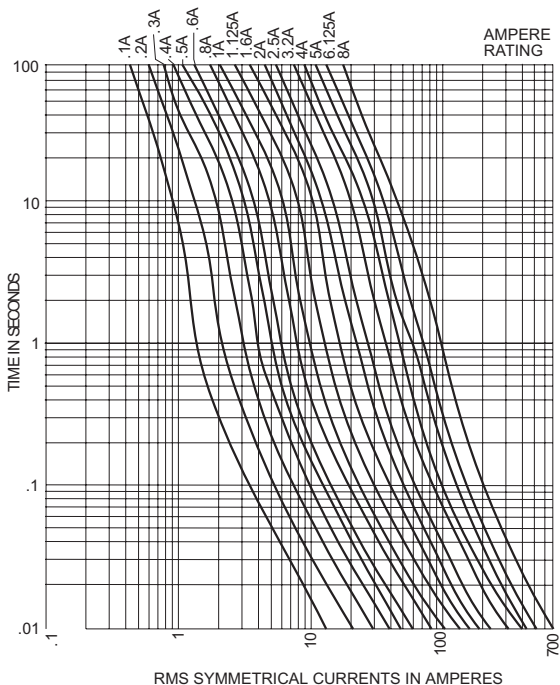

# Dual Element Time-Delay Class RK5 Fuses



## ECNR/ECSR Curves

### PEAK LET-THROUGH CURRENT CURVES\*

ECNR (250V)

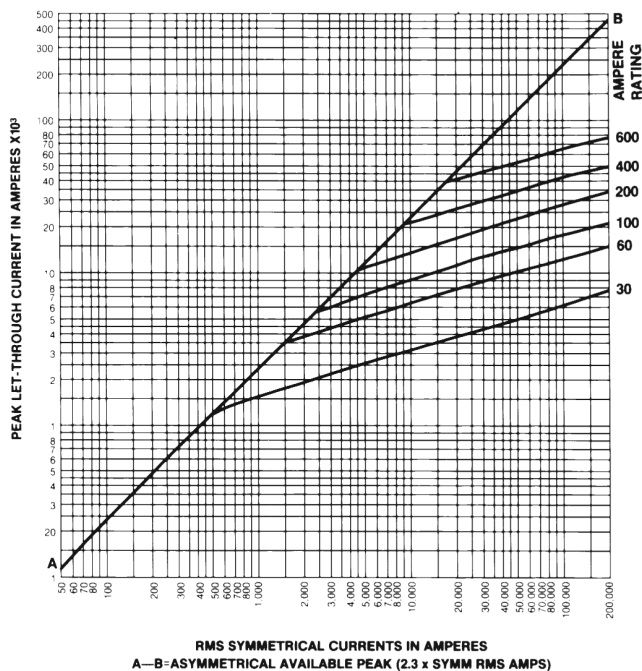

ECSR (600V)

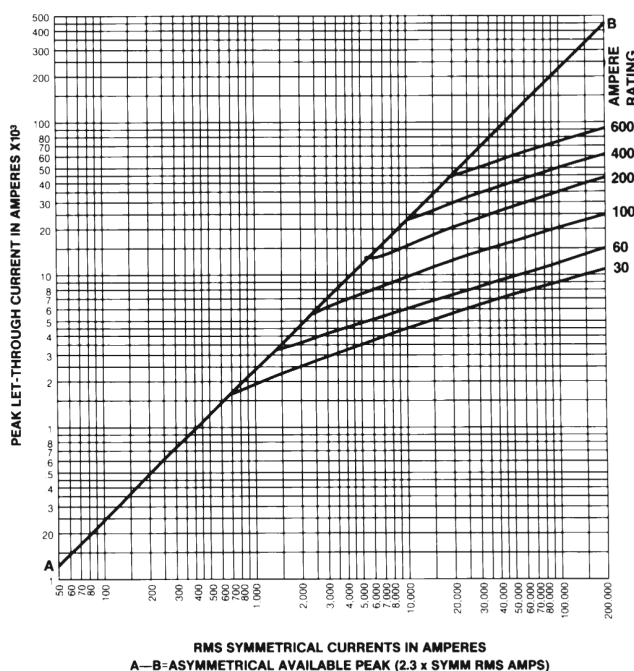

### CURRENT LIMITATION TABLES

ECNR (250V)\*

Available Fault Current RMS Amps	Apparent Effective Let-Thru Amperes					
	Fuse Ampere Ratings					
	30A	60A	100A	200A	400A	600A
5,000	1,050	2,070	2,820	4,300	5,000	5,000
10,000	1,310	2,570	3,630	5,400	8,700	10,000
15,000	1,490	2,920	4,140	6,200	9,900	15,000
20,000	1,630	3,200	4,500	6,800	10,700	16,100
25,000	1,720	3,420	4,800	7,200	11,400	17,200
30,000	1,840	3,630	5,100	7,700	12,100	18,300
35,000	1,920	3,810	5,400	8,100	12,600	19,200
40,000	2,000	3,980	5,600	8,500	13,100	19,900
50,000	2,140	4,200	6,000	9,100	14,000	21,400
60,000	2,260	4,500	6,400	9,600	14,900	22,600
80,000	2,450	4,900	7,000	10,600	16,000	24,600
100,000	2,620	5,200	7,500	11,400	17,100	26,200
150,000	2,920	5,800	8,300	13,000	19,200	29,200
200,000	3,140	6,200	8,900	14,300	20,800	31,700

ECSR (600V)\*

Available Fault Current RMS Amps	Apparent Effective Let-Thru Amperes					
	Fuse Ampere Ratings					
	30A	60A	100A	200A	400A	600A
5,000	1,290	2,070	2,980	5,000	5,000	5,000
10,000	1,640	2,590	3,810	6,500	8,800	10,000
15,000	1,890	2,940	4,400	7,500	10,200	15,000
20,000	2,110	3,250	4,800	8,300	11,400	18,200
25,000	2,260	3,470	5,200	8,900	12,400	19,600
30,000	2,420	3,660	5,500	9,600	13,200	21,100
35,000	2,570	3,850	5,800	10,100	14,100	22,400
40,000	2,670	4,030	6,000	10,500	14,700	23,400
50,000	2,890	4,300	6,500	11,400	16,000	25,300
60,000	3,060	4,500	6,900	12,100	17,200	27,000
80,000	3,360	4,900	7,600	13,400	19,100	29,500
100,000	3,630	5,200	8,200	14,400	20,700	31,700
150,000	4,100	5,800	9,300	16,500	23,900	36,300
200,000	4,400	6,100	10,400	18,300	26,700	39,500

\*"Apparent Let-Thru Amperes" values are read from "Peak Let-Through Current Curves" and the peak current value divided by 2.3 Asymmetry Factor.



# Selection Guide

## Line Overview

The Edison family of fuses, fuse blocks and fuse holders is divided into two classes:

1. Current Limiting: Class CC, Class J, Class L, Class RK, Class T
2. General Purpose: Class M Midget and Small Dimension

The fuse selection guide below is a general summary of the

specifications included for each fuse type. This selection guide does not include the many variables that can exist for specific situations such as local codes, unusual temperature, or other operating conditions. When selecting fuses, be sure to comply with any applicable PUBLIC SAFETY standards that apply to Overcurrent Protection Devices (OPD).

Edison Fuses Selection Guide and General Specifications												
Description	Current Limiting											
	Class J		Class RK5		Class RK1		Class T		Class L	Class CC		
Fuse Type	Fast-Acting	Time-Delay	Time-Delay				Extremely Fast-Acting	Fast-Acting	Fast-Acting	Time-Delay		
Part Number	JHL	JDL	ECNR	ECSR	LENRK	LESRK	TJN	TJS	LCU	HCLR	HCTR	EDCC
Voltage Rating	600VAC 450VDC	600VAC 300VDC*	250VAC 125 VDC* (1-200A) 250VDC* (201-600A)	600VAC 300VDC*	250VAC 125 VDC* (10-60A) 250VDC* (70-600A)	600VAC 300VDC*	300VAC 160 VDC (15-600A)	600VAC	600V	600VAC 300VDC (15-20A)	600VAC	600VAC 300VDC (0.5-2.25A) (20-30A)
Amp Rating	1 - 600		1 - 600	3 - 600	10 - 600	5 - 600	1 - 600		601 - 1200	0.5 - 30	0.25 - 30	0.5 - 30
Interrupting Rating	200,000 RMS Symmetrical Amps											
Current Limiting	Class J		Class RK5		Class RK1		Class T		Class L	Class CC		
Agency Approvals	UL Listed Class J Guide JDDZ File E162363 CSA Certified HRCI-J per C22.2, No. 248.8 File 700489 RoHS compliant	UL Listed Class J Guide JDDZ File E162363 CSA Certified HRCI-J per C22.2, No. 248.8 File 700489	UL Listed, Class RK, Guide JDDZ, File E162363 CSA Certified HRCI-R per C22.2, No. 248.12, File 700489 (LENRK CSA File 053787)				UL Listed, Class T, Guide JDDZ, File E162363 CSA Certified HRCI-T per C22.2, No. 248.12, File 53787, Class 1422-02 & 1422-82		UL Listed, Std. 248-10 CSA Certified, HRC-L C22.2 No. 248.10, Class 1422- 02, File 53787	UL Listed to 248.4, Class CC, Guide JDDZ, File E162363, CSA certified HRCI-MISC per C22.2 No. 248.4, File 700489		
Dimensions	See product specification pages.									ferrule (in): 13/32, length (in): 1-1/2		

\* Self-certified DC ratings

Edison Fuses Selection Guide and General Specifications													
Description	General Purpose – Midget				General Purpose – Small Dimension Electronic								
	Fast-Acting		Time-Delay		Fast-Acting Ceramic	Fast-Acting Glass		Medium Time-Delay Glass	Time-Delay Ceramic	Time-Delay Glass	Fast-Acting Glass	Time-Delay Glass	
Part Number	MCL	MOL	MEQ	MEN	ABC	AGC	GMA	GMC	MDA	MDL	S500	S506	
Voltage Rating	600 VAC	250 VAC	500 VAC	250 VAC	250 VAC (0.5 to 30A) 125VDC: (0.5 to 30A)	250VAC: (0.1 to 10A) 32VAC: (15 to 30A)	250VAC (0.063 - 3A) 125VAC (4 - 15A)	250VAC (0.5 - 3A) 125VAC (4 - 10A)	250VAC 125VDC (20A)	250VAC: (0.0625 to 8A) 32VAC: (10 to 20A)	250VAC	250VAC	
Amp Rating	0.5 to 50	0.5 to 30	0.25 to 30	0.5 to 30	0.5 to 30	0.10 to 30	0.063 to 15	0.5 to 10	0.5 to 20	0.0625 to 20	0.032 to 10	0.25 to 6.3	
Interrupting Rating	100,000 RMS Amps	10,000 RMS Amps				See specifications table on product pages							
Current Limiting	N/A				N/A								
Agency Approvals	UL Listed to 248.14, File E162443 CSA Cert. C22.2 Part 59.2, LR 700489				UL Listed standard 248-14 UL Listed Guide and File nos. (ABC 0.25-20 A): (AGC 1/100-10 A) JDYX and E19180 UL Recognition Guide and File nos. (ABC 20-30A):(AGC 11-30) JDYX2 and E19180 CSA Certification Record No: 053787 C 000 and Class No: 1422 01 and 1422 30	Designed to UL/CSA 248-14 UL Listed, Guide JDYX, File E19180 63mA-6A UL Recognition, Guide JDYX2, File E19180, 7A-15A CSA Certified, File 053787_C_000, 63mA-6A Class 1422-01		UL Listed standard 248-14 UL Listed Card: MDA 2/10-20A, MDL 1/16-8A (Guide JDYX, File E19180 UL Recognized Card: MDA 25-30A MDL 9-30A (Guide JDYX2, File E19180) CSA Certification Card: MDA 2/10-15A (Class No. 1422-01)		UL Recognized Guide JDYX2, File E19180 Semko Approval VDE Approval BSI Approval IMQ Approval RoHS compliant			
	RoHS												
Dimensions	ferrule (in): 13/32 length (in): 1-1/2				1/4" x 1-1/4", (6.3mm x 32mm)		0.197" x 0.788" (5mm x 20mm)		1/4" x 1-1/4", (6.3mm x 32mm)		0.197" x 0.788" (5mm x 20mm)		



# Modular Ferrule Fuse Blocks for Class R Fuses



## Description

RM Series for use with Class R fuses LENRK, LESRK, ECNR & ECSR

## Mounting

35mm DIN rail or panel mount

## Specifications

### Materials:

- Base – Thermoplastic
- Terminals – Tin-plated copper brass
- Covers – Thermoplastic
- Screws – Zinc-plated steel

**SCCR:** 200kA

### Flammability rating:

- Blocks – UL 94V0, self-extinguishing
- Covers – UL 94HB, self-extinguishing

### Operating and storage temp range:

- Blocks – -40° to 120°C [-40° to 248°F]
- Covers – indicating -20° to 90°C [-4° to 194°F]
- non-indicating -40° to 120°C [-40° to 248°F]

### Wire:

- Cu – 75°/90°C [ 167°/194°F]
- Al – 75°C [167°F]
- Ring or Fork terminal to fit a #10-32 screw

## Agency Approvals

### Fuse Blocks

- UL® Listed E14853 - IZLT
- CSA® Certified 47235-6225-01
- CE
- RoHS Compliant
- Conflict mineral free
- REACH Compliant

### Covers

- Covers are included in the overall UL Listing/Recognition and CSA Certification
- IP20 finger-safe
- RoHS compliant
- REACH Compliant

To obtain the most current agency approval information, see the Agency Approval Checklist section on the specific part number's web page.

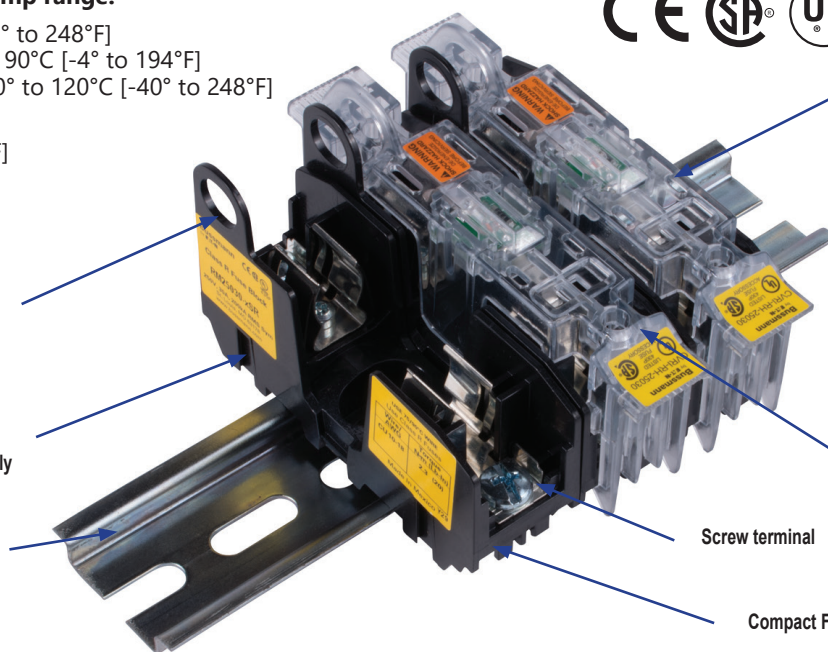

Clear IP20 finger-safe cover (sold separately)

Modular Ferrule Fuse Blocks for Class R Fuses														
Type	Part Number	Pc/pkg	Price	Volts	Amps	Poles	Wire Range		Torque lb-in [N·m]	Wt. lb [kg]	Covers (sold separately)			
							solid and stranded	fine stranded (Cu)			w/o Indication	w/ Indication <sup>1</sup>	Pc/pkg	
Screw	<a href="#">RM25030-1SR</a>	1	\$15.50	250V AC/DC	30	1	18-10 AWG (Cu)	18-10 AWG	20 [2.3]	0.10 [0.04]	<a href="#">CVR-RH-25030</a> \$10.00	<a href="#">CVRI-RH-25030</a> \$13.00	1	
	<a href="#">RM25030-2SR</a>	1	\$25.00			2								0.15 [0.07]
	<a href="#">RM25030-3SR</a>	1	\$38.00			3								0.25 [0.12]
Box Lug	<a href="#">RM25060-1CR</a>	1	\$30.00		60	1	14-2 AWG (Cu) 8-2 AWG (Al)	3-2 AWG 6-4 AWG 8 AWG 14-10 AWG	50 [5.6] 45 [5.1] 40 [4.5] 35 [4.0]	0.15 [0.07] 0.30 [0.14] 0.45 [0.22]	<a href="#">CVR-RH-25060</a> \$12.00	<a href="#">CVRI-RH-25060</a> \$13.50	1	
	<a href="#">RM25060-2CR</a>	1	\$53.00			2								
	<a href="#">RM25060-3CR</a>	1	\$71.00			3								
Screw	<a href="#">RM60030-1SR</a>	1	\$33.50	600V AC/DC	30	1	18-10 AWG (Cu)	18-10 AWG	20 [2.3]	0.15 [0.07] 0.30 [0.14] 0.45 [0.22]	<a href="#">CVR-RH-60030</a> \$10.50	<a href="#">CVRI-RH-60030</a> \$13.00	1	
	<a href="#">RM60030-2SR</a>	1	\$51.00			2								
	<a href="#">RM60030-3SR</a>	1	\$62.00			3								
Box Lug	<a href="#">RM60060-1CR</a>	1	\$42.00		60	1	14-2 AWG (Cu) 8-2 AWG (Al)	3-2 AWG 6-4 AWG 8 AWG 14-10 AWG	50 [5.6] 45 [5.1] 40 [4.5] 35 [4.0]	0.25 [0.12] 0.45 [0.22] 0.70 [0.30]	<a href="#">CVR-RH-60060</a> \$12.00	<a href="#">CVRI-RH-60060</a> \$13.50	1	
	<a href="#">RM60060-2CR</a>	1	\$70.00			2								
	<a href="#">RM60060-3CR</a>	1	\$127.00			3								

<sup>1</sup> Open fuse indication requires 90V minimum and closed circuit to operate.



# Modular Ferrule Fuse Blocks for Class R Fuses Dimensions

in [mm]

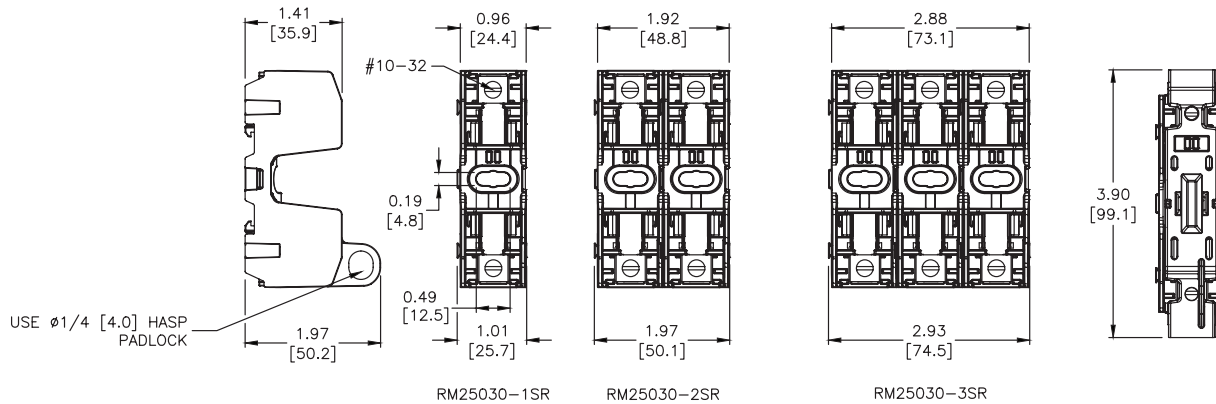

RM25030

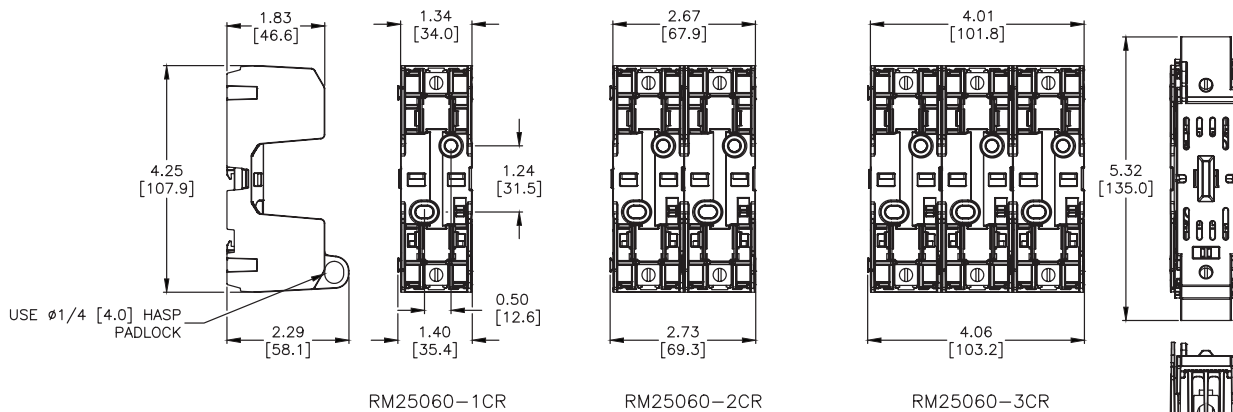
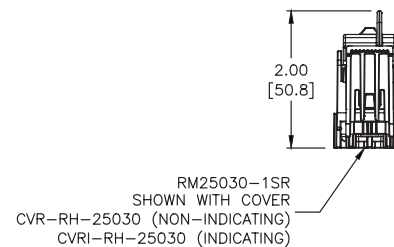

RM25060

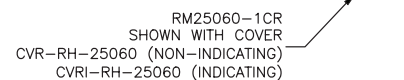

Please see our website [www.AutomationDirect.com](http://www.AutomationDirect.com) for complete engineering drawings. Dimensions are approximate. Not for construction purposes.



# Modular Ferrule Fuse Blocks for Class R Fuses Dimensions

in [mm]

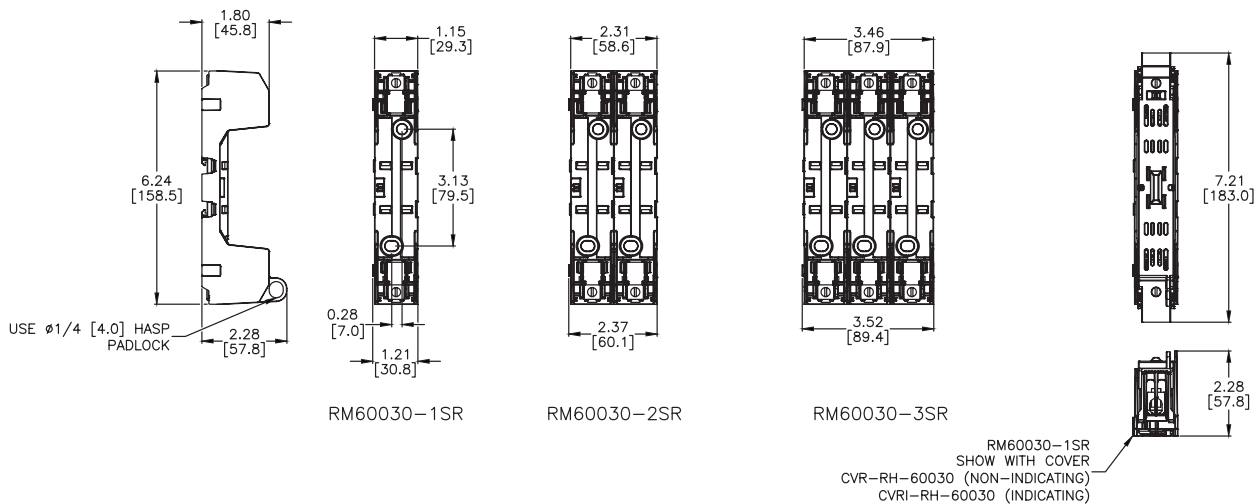

RM60030

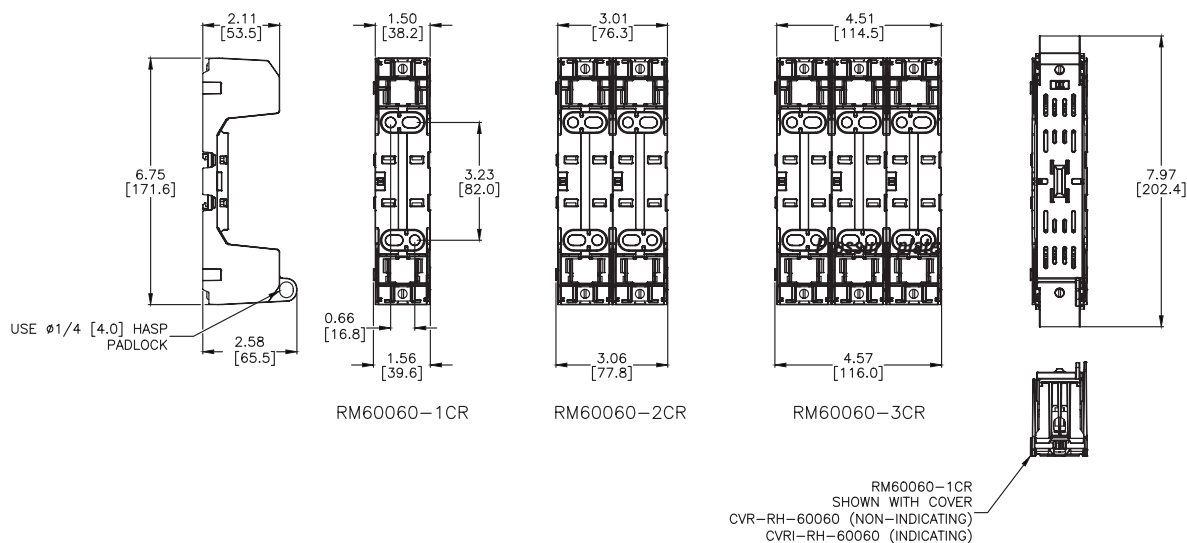

RM60060

Please see our website [www.AutomationDirect.com](http://www.AutomationDirect.com) for complete engineering drawings. Dimensions are approximate. Not for construction purposes.



# Accessories



**FP-2**

Accessories			
Part Number	Description	Pcs/Pkg	Price
<b>FP-2</b>	Fuse puller for fuse dia. 13/32" - 13/16". Fuse type: 0-60A, 250V; 0-30A, 600V	1	\$34.50
<b>JV-L*</b> <i>(Not Field Installable)</i>	Multi-pole connection kit to connect new design multiple Class CC and Midget Class fuse holders together. Kit consists of 6 connectors and 3 handle pins to connect up to 4 fuse holders.		\$13.00

*Note: Will not work with retired design fuse holders shipped before November 1, 2009.*

*\*Roll pin punch or installation tool is required to install handle pins (Tool not sold by [AutomationDirect.com](http://AutomationDirect.com)).*

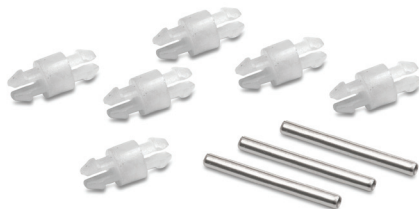

**JV-L**

Handle Pin Dimensions  
 Diameter = 0.0625 in [1.58 mm]  
 Length = 0.632 in [16.07 mm]

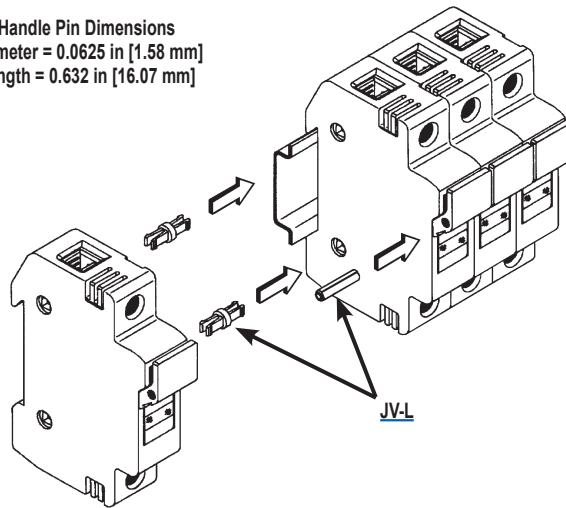

**JV-L**

# Cross Reference Guide



## CROSS REFERENCE GUIDE By manufacturers type reference or series number. Ampere ratings must be added for ordering purposes.

FUSE TYPE		VOLT	EDISON	BRUSH/ DORMAN	BUSSMANN	MERSEN / GOULD	GEC/CEFCO	LITTELFUSE
<b>UL CLASS CURRENT LIMITING FUSES (CSA CLASS)</b>								
<b>CC (HRCI-CC)</b>	<i>Time-Delay</i>	600	EDCC	-	LP-CC	ATDR	-	CCMR
	<i>Time-Delay</i>	600	HCTR	-	FNQ-R	ATQR	-	KLDR
	<i>Fast-Acting</i>	600	HCLR	HCLR	KTK-R	ATMR	CTK-R	KLKR
<b>RK1</b>	<i>Time-Delay Dual Element</i>	250	LENRK	-	LPN-RK-SP	A2DR	-	LLNRK
		600	LESRK	-	LPS-RK-SP	A6DR	-	LLSRK
<b>RK5</b>	<i>Time-Delay Dual Element</i>	250	ECNR	-	FRN-R	TR	-	FLNR
		600	ECSR	-	FRS-R	TRS	-	FLSR
<b>J</b>	<i>Time-Delay Dual Element</i>	600	JDL	-	LPJ	AJT	-	JTD
	<i>High-Speed AC Drive</i>	600	JHL	-	DFJ	HSJ	-	-
<b>T</b>	<i>Extremely Fast-Acting</i>	300	TJN	-	JJN	A3T	-	JLLN
		600	TJS	-	JJS	A6T	-	JLLS
<b>UL CLASS GENERAL PURPOSE FUSES</b>								
<b>Midget</b>	<i>Fast-Acting</i>	600	MCL	MCL	KTK	ATM	CTK	KLK
		250	MOL	MOL	BAF/BAN	OTM	-	BLF
	<i>Time-Delay</i>	500	MEQ	MEQ	FNQ	ATQ	-	FLQ
		250	MEN	MEN	FNM	TRM	-	FLM
<b>1/4"x 1-1/4" Ceramic</b>	<i>Fast-Acting</i>	250/125	ABC	ABC	ABC	GAB	-	314
<b>1/4"x 1-1/4" Glass</b>		250/32	AGC	AGC	AGC	GGC	-	312
<b>1/4"x 1-1/4" Ceramic</b>	<i>Time-Delay</i>	250	MDA	MDA	MDA	-	-	326
<b>1/4"x 1-1/4" Glass</b>		250/32	MDL	MDL	MDL	GDL	-	313
<b>5x20 mm Glass</b>	<i>Fast-Acting</i>	250/125	GMA	GMA	GMA	GGM	-	235
	<i>Medium Time-Delay</i>	250/125	GMC	GMC	GMC	GSC	-	-
<b>5x20 mm Glass</b>	<i>Fast-Acting</i>	250	S500	BDB	GDB	GSB	-	217
	<i>Time-Delay</i>	250	S506	BDC	GDC	GDG	-	218
<b>Fuse Puller</b>								
<b>Fuse Puller FP-2</b>			old - 38072 new - FP-2	-	FP-2	-	-	-