

# AE16 Starter Specifications

45mm Cutler-Hammer AE16 Starter Specifications								
Starter Model			AE16AN	AE16BN	AE16CN	AE16DN	AE16EN	AE16FN
Insulation Voltage	AC	(V)	690 Volts AC					
Ampere Rating	Max. UL Current (AC3) <sup>1</sup>	(A)	7	10	12	18	25	32
	AC1 Thermal Current (600V) <sup>2</sup>	(A)	20	20	20	32	32	32
Maximum Power (hp) of Three-Phase Motors	200V	(hp)	1.5	2	3	5	5	7.5
	230/240V	(hp)	1.5	2	3	5	7.5	10
	460/480V	(hp)	3	5	7.5	10	15	20
	575V	(hp)	5	7.5	10	15	20	25
Maximum Power (hp) of Single-Phase Motors	115V	(hp)	0.25	0.5	0.5	1	2	2
	230/240V	(hp)	0.5	1	2	3	3	5
Maximum Power (kw) of Three-Phase Motors AC3 Category <sup>1</sup>	230/240V	(kW)	1.1	1.5	2.2	4	5.5	7.5
	415/440V	(kW)	2.2	4	5.5	7.5	11	15
	500/550V	(kW)	2.2	4	5.5	7.5	11	15
	500V	(kW)	4	5.5	7.5	11	15	18.5
	600V	(kW)	1.5	2.2	4	5.5	7.5	10
Auxiliary Contacts Electrical Capacity			A600 <sup>4</sup>					
SCCR			5kA					
Coil Voltage Operating Limits			AC Pick-Up 85-110% Rated Control Voltage / AC Drop-Out 45% Rated Control Voltage					
Average Coil Power Requirements / Coil current (A) = VA/Coil Voltage			AC Pick-Up (VA) 80-100 / AC Sealed (VA) 7.5-10					
Power Factor			Pick-Up .65 / Sealed .35					
Coil Operating Time at Rated Coil Voltage			Pick-Up (ms) 12 / Drop-Out (ms) 12					
Maximum Operating Frequency (No-Load Operation)			Pick-Up (ms) 12 / Drop-Out (ms) 12					
Mechanical Durability			10,000,000 Operations					
Electrical Durability in Operations (AC3) <sup>1</sup>			2,000,000	2,000,000	2,220,222	1,300,000	1,600,000	1,500,000
Operating Ambient Temperature			-25° to +55°C					
Electrical Protection Degree			IP20 (IP10 for AE16DN, AE16EN, AE15FN)					
Mounting			Screw or 35mm DIN Rail					
Wire Sizes	Line / Load		#12 - 16 AWG stranded recommended			#16 - #8 stranded recommended		
	Control & Auxiliary Contacts		#12 - #14 AWG (stranded recommended)					
Line/Load Tighting Torque	N•m (lb•in)		7			15		

- AC3 type loads consist of squirrel cage three phase motors.
- AC1 non-inductive or slightly inductive loads. Typically resistive loads (i.e. furnaces, ovens, etc.)
- Type 2 coordination is a protection category for IEC 60947-4-1. Section 8.2.5.1 specifies that type 2 coordination requires that, under short circuit conditions, the contactor or starter shall cause no danger to persons or installations and shall be suitable for further use. The risk of minor contact welding is possible.
- NEMA ICS 5-2000. For more information, refer to Control Circuit Contact Electrical Ratings, page MRC-tMRC-130.

Cutler-Hammer AE16 Series Starter Part Numbers									
IEC FRAME SIZE	Cutler-Hammer Contactor Model	Part Number	Price	Number of Contacts			Coil Voltage and Frequency	Additional Contacts	
				Main	Auxiliary Contacts Included			Maximum Contact Block Arrangement	Type of Additional Contact Block
					N.O	N.C.			
45mm	AE16AN	<a href="#">AE16ANS0AC</a>	\$466.00	3	1		110-120VAC 50-60Hz	Up to two auxiliary contact blocks may be added to AE16 contactors (one per side).	Side mount <a href="#">C320KGS3</a> (1 NO and 1 NC) <a href="#">C320KGS1</a> (1 NO and 1 NC)
		<a href="#">AE16ANS0BC</a>	\$507.00	3	1		220-240VAC 50-60Hz		
	AE16BN	<a href="#">AE16BNS0AC</a>	\$517.00	3	1		110-120VAC 50-60Hz		
		<a href="#">AE16BNS0BC</a>	\$517.00	3	1		220-240VAC 50-60Hz		
	AE16CN	<a href="#">AE16CNS0AC</a>	\$592.00	3	1		110-120VAC 50-60Hz		
		<a href="#">AE16CNS0BC</a>	\$592.00	3	1		220-240VAC 50-60Hz		
	AE16DN	<a href="#">AE16DNS0AC</a>	\$640.00	3	1		110-120VAC 50-60Hz		
		<a href="#">AE16DNS0BC</a>	\$640.00	3	1		220-240VAC 50-60Hz		
	AE16EN	<a href="#">AE16ENS0AC</a>	\$691.00	3	1		110-120VAC 50-60Hz		
		<a href="#">AE16ENS0BC</a>	\$691.00	3	1		220-240VAC 50-60Hz		
	AE16FN	<a href="#">AE16FNS0AC</a>	\$764.00	3	1		110-120VAC 50-60Hz		
		<a href="#">AE16FNS0BC</a>	\$764.00	3	1		220-240VAC 50-60Hz		

Note: Holding circuit contact(s) supplied standard: a N.O. auxiliary contact block is mounted on the right-hand side. (On Sizes A-C, contact occupies fourth power pole position-no increase in width.)

# EAT•N Motor Control Dimensions

Size and Dimensions (Inches)										
Product	IEC Size	Contactor Type								Ship Weight in Pounds
		Wide	High	Deep	Mounting					
		A	B	C	D	E	E1	F	G	
Starters	A-F	1.80	5.86	3.28	1.36	5.19	5.39	-	54	1.75
Contactors	A-C	1.80	2.96	3.26	1.36	1.96	-	-	54	1.3
Contactors	D-F	1.80	2.96	3.26	1.36	1.96	-	-	54	1.4
Overload Relays	32 Amp	1.77	4.13	3.69	1.36	3.74	-	-	-	0.8

IEC contactor sizes A-F, CE15

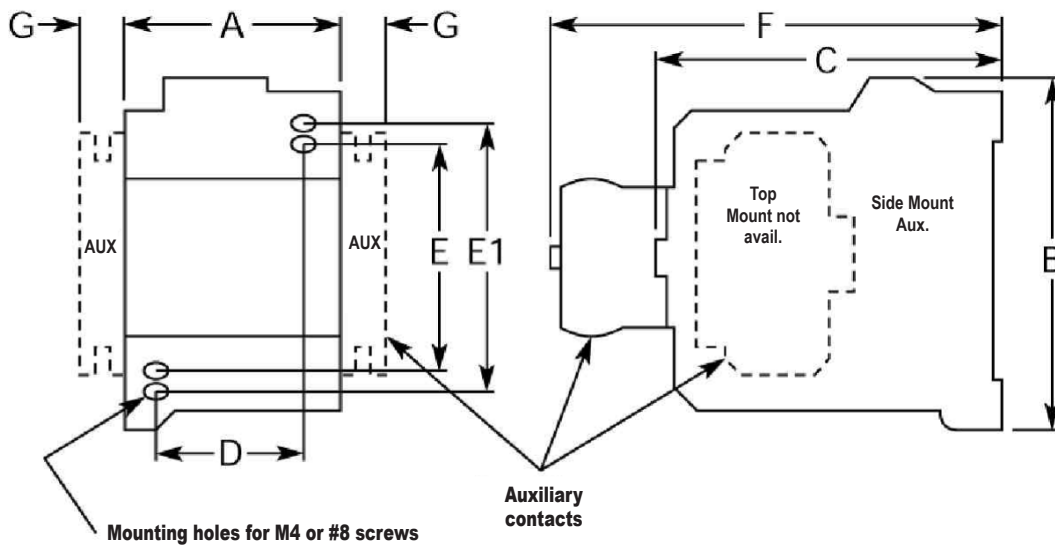

IEC starter sizes A-F, AE16

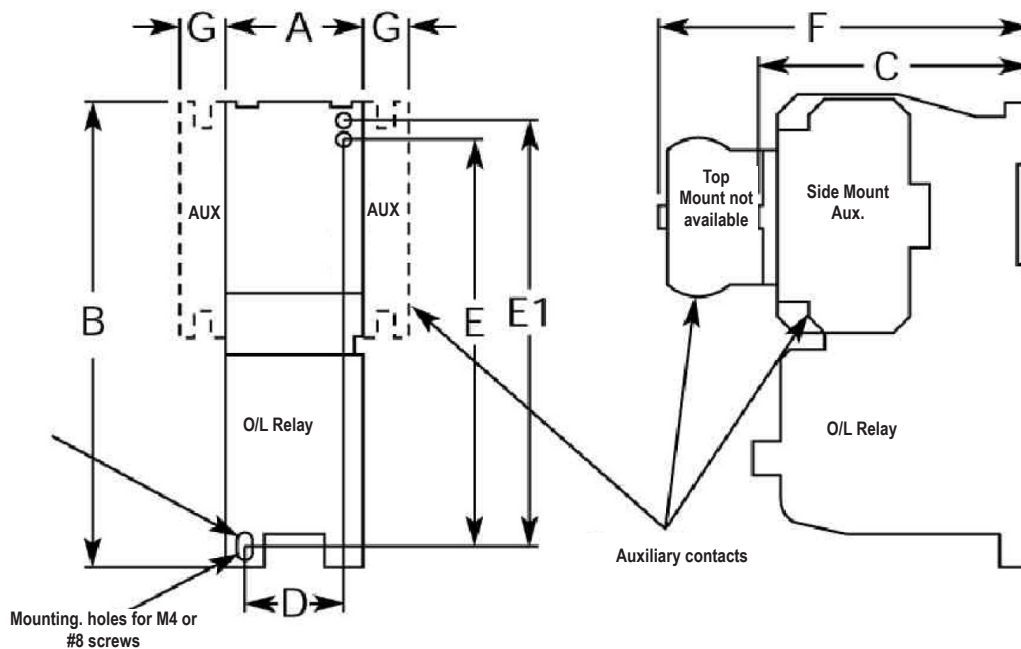

# Electrical Ratings Charts

## Motor Current Ratings

Full Load Ampere (FLA) Rating for AC Induction Motors							
Motor HP	115 VAC		200 VAC		230 VAC		460 VAC
	1-Phase (A)	3-Phase (A)	1-Phase (A)	3-Phase (A)	1-Phase (A)	3-Phase (A)	3-Phase (A)
1/10	3.0	---	---	---	1.5	---	---
1/8	3.8	---	---	---	1.9	---	---
1/6	4.4	---	2.5	---	2.2	---	---
1/4	5.8	---	3.3	---	2.9	---	---
1/3	7.2	---	4.1	---	3.6	---	---
1/2	9.8	4.4	5.6	2.5	4.9	2.2	1.1
3/4	13.8	6.4	7.9	3.7	6.9	3.2	1.6
1	16.0	8.4	9.2	4.8	8.0	4.2	2.1
1 1/2	20.0	12.0	11.5	6.9	10	6.0	3.0
2	24.0	13.6	13.8	7.8	12	6.8	3.4
3	34.0	19.2	19.6	11.0	17	9.6	4.8
5	56.0	30.4	32.2	17.5	28	15.2	7.6
7 1/2	80.0	44.0	46.0	25.3	40	22	11
10	100.0	56.0	57.5	32.2	50	28	14
15	---	84.0	---	48.3	---	42	21
20	---	108.0	---	62.1	---	54	27
25	---	136.0	---	78.2	---	68	34
30	---	160.0	---	92	---	80	40
40	---	208.0	---	120	---	104	52
50	---	260.0	---	150	---	130	65
60	---	---	---	177	---	154	77
75	---	---	---	221	---	192	96
100	---	---	---	285	---	248	124

The motor currents are approximate and not guaranteed to be accurate. This chart is provided as a guideline only. Values were extrapolated from NEC Tables 430-148 and 430-150. Motor currents should be taken from the motor's nameplate. It is the user's responsibility to properly size their motor control devices.

## Control Circuit Contact Electrical Ratings

NEMA Mechanical Switching Ratings and Test Values for DC Control Circuit Contacts					
Contact Rating Designation	Thermal Continuous Test Current (A)	Maximum Make or Break DC Current (A)			Voltamperes
		125 Volts	250 Volts	301 to 600 Volts	
P300	5.0	1.1	0.55	---	138
P600	5.0	1.1	0.55	0.20	138
Q300	2.5	0.55	0.27	---	69
Q600	2.5	0.55	0.27	0.10	69
R300	1.0	0.22	0.11	---	28

This chart is provided as a guideline only, and the ratings and values are not guaranteed to be accurate. It is the users' responsibility to properly size their control circuit devices. The chart values are from NEMA Standard ICS 5-2000, Table 1-4-2.

NEMA Mechanical Switching Ratings and Test Values for AC Control Circuit Contacts											
Contact Rating Designation	Thermal Continuous Test Current (A)	Maximum AC Current, 50/60Hz (A)								Voltamperes	
		120 Volts		240 Volts		480 Volts		600 Volts			
		Make	Break	Make	Break	Make	Break	Make	Break	Make	Break
A300	10	60	6.00	30	3.00	---	---	---	---	7200	720
A600	10	60	6.00	30	3.00	15	1.50	12	1.20	7200	720
B300	5	30	3.00	15	1.50	---	---	---	---	3600	360
B600	5	30	3.00	15	1.50	7.5	0.75	6	0.60	3600	360
C600	2.5	15	1.5	7.5	0.75	3.75	0.375	3.00	0.30	1800	180

This chart is provided as a guideline only, and the ratings and values are not guaranteed to be accurate. It is the users' responsibility to properly size their control circuit devices. The chart values are from NEMA Standard ICS 5-2000, Table 1-4-1.

# IEC Utilization Categories

IEC Utilization Categories for Low Voltage Switchgear and Control Gear			
Current	Category	Typical Applications	Relevant IEC Product Standard <sup>3</sup>
AC	AC-1	Non inductive or slightly inductive loads, resistance furnaces, heaters	60947-4
	AC-2	Slip-ring motors: switching off	
	AC-3	Squirrel-cage motors: starting, switching off motors during running most typical industrial application	
	AC-4	Squirrel-cage motors: starting, plugging <sup>1</sup> , inching <sup>2</sup>	
	AC-5a	Switching of electric discharge lamps	
	AC-5b	Switching of incandescent lamps	
	AC-6a	Switching of transformers	
	AC-6b	Switching of capacitor banks	
	AC-7a	Slightly inductive load in household appliances: mixers, blenders	
	AC-7b	Motor-loads for household applications: fans, central vacuum	
	AC-8a	Hermetic refrigerant compressor motor control with manual resetting overloads	60947-5
	AC-8b	Hermetic refrigerant compressor motor control with automatic resetting overloads	
	AC-12	Control of resistive loads and solid state loads with opto-coupler isolation	60947-5
	AC-13	Control of solid state loads with transformer isolation	
	AC-14	Control of small electromagnetic loads	60947-3
	AC-15	Control of AC electromagnetic loads	
	AC-20	Connecting and disconnecting under no-load conditions	
	AC-21	Switching of resistive loads, including moderate loads	60947-3
	AC-22	Switching of mixed resistive and inductive loads, including moderate overloads	
	AC-23	Switching of motor loads or other highly inductive loads	
AC and DC	A	Protection of circuits, with no rated short-time withstand current	60947-2
	B	Protection of circuits, with a rated short-time withstand current	
DC	DC-1	Non-Inductive or slightly inductive loads, resistance furnaces, heaters	60947-4
	DC-3	Shunt-motors, starting, plugging <sup>1</sup> , inching <sup>2</sup> , dynamic breaking of motors	
	DC-5	Series-motors, starting, plugging <sup>1</sup> , inching <sup>2</sup> , dynamic breaking of motors	
	DC-6	Switching of incandescent lamps	
	DC-12	Control of resistive loads and solid state loads with opto-coupler isolation	60947-5
	DC-13	Control of DC electromagnetics	
	DC-14	Control of D.C. electromagnetic loads having economy resistors in the circuit	60947-5
	DC-20	Connecting and disconnecting under no-load conditions	
	DC-21	Switching of resistive loads, including moderate overloads	60947-3
	DC-22	Switching of mixed resistive and inductive loads, including moderate overloads (i.e. shunt motors)	
	DC-23	Switching of highly inductive loads (i.e. series motors)	

<sup>1</sup>Plugging - Stopping a motor rapidly by reversing the primary power connections.

<sup>2</sup>Inching - Energizing a motor repeatedly for short periods to obtain small incremental movements.

<sup>3</sup>IEC Standards must be purchased from the International Electrotechnical Commission