

# Eaton Quality at AutomationDirect Prices

## FAZ Series Supplementary Protectors

FAZ Supplementary Protectors are UL 1077 recognized for applications where branch circuit protection is not required or is already provided. They are thermal magnetic and protect against short circuit (see ratings chart) and overload conditions.

These DIN-rail mounted supplementary protectors come in one, two and three pole configurations and are available in three trip curves.

The B curve magnetic trip point is 3 to 5 times the rated current and is typically used for computers and electronic loads with very low current loads.

The C curve magnetic trip point is 5 to 10 times the rated current and is typically used for small transformers, pilot devices, etc.

The D curve magnetic trip point is 10 to 20 times the rated current and is typically used for transformers or with very high inductive loads.

Shunt trips are available for remotely tripping the protector with an external voltage from a control system or alarm device.

A padlocking feature is also available for preventing unauthorized operation. Maintenance personnel can safely work on protected equipment without electrical safety concerns.

1, 2 and 3-pole models



### Third party Certification and marking

- UL recognized under UL 1077 Category QVNU2, File E177451
- CSA 22.2, No. 235 File 204453
- CE File LVD 2006/95/EC
- IEC 60898
- IEC 60947-2



### Full line of field installable accessories

- Auxiliary switch
- Alarm/Auxiliary Switch
- Shunt trip
- Padlock provision
- Busbar systems

### Trip curves

- B [3-5 I<sub>n</sub>]
- C [5-10 I<sub>n</sub>]
- D [10-20 I<sub>n</sub>]

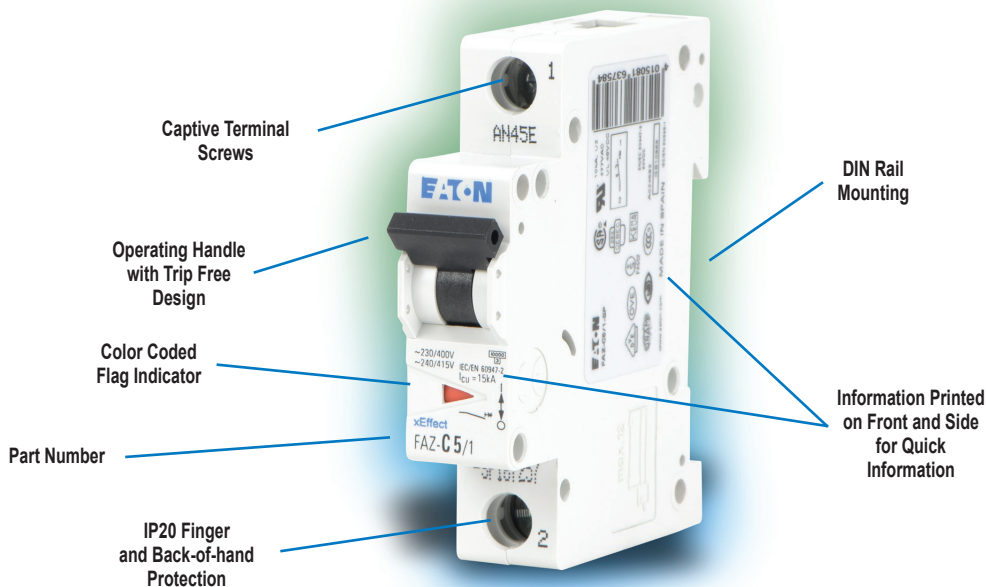

## Overview

The Eaton FAZ supplementary protectors are used to provide overcurrent protection where branch protection (for example, UL 489 MCCB) is already provided or not required. The units can be installed as a component within, or as a part of an appliance or a piece of electrical equipment. Supplementary protectors are ideal replacements for fuses that are applied as a supplementary protector, i.e. in addition to branch protection (if required). They are 35mm DIN-rail mountable, utilizing spring clips. These are standard protectors, recognized by UL and CSA under UL 1077 and CSA 22.2. They are CE marked in accordance with Low Voltage Directive (LVD) (73/23/EEC).



## Product Specification

The FAZ supplementary protector is a dual-rated product for both AC and DC supplies, in accordance with UL 1077 and CSA 22.2 standards and is marked with CE in accordance with the Low Voltage Directive. With this dual standard product, you can include it in your design, knowing that in most cases wherever your equipment is used, the product will conform to the local UL, CSA or IEC (International) requirements.

The supplementary protector is designed to be applied in conjunction with a branch circuit protector (if branch protection is required) and can be a replacement for similarly applied fuses. Its advantage over fuses is that it is resettable and the device's status is easily and clearly identified by the position of the handle and the flag indicator.

## Listings

- UL recognized under UL 1077 Category QVNU2 File E177451
- CSA 22.2, No. 235 File 204453

## Applications

FAZ Supplementary protectors are recognized per UL 1077 and certified per CSA C22.2 No. 235 as a Supplementary Protector and can be fully utilized per the NEC and CEC Codes in that capacity. For international purposes, the entire FAZ family is CE marked and in full conformity with the applicable IEC standards for miniature circuit breakers, EN/IEC 60898 and IEC/EN 60947-2.

Outside North America, they can be used in both residential and industrial applications as feeder and branch circuit

[www.automationdirect.com](http://www.automationdirect.com)

In addition, you can select a device that provides maximum reliability and accuracy to fit various applications due to the availability of a wide range of current ratings from 0.5 to 63 amperes in three overcurrent characteristic curves, B, C and D.

## Features and Benefits

- Dual rated for AC or DC Applications
- Box terminals accept #18 to #4 wire (1 to 25mm<sup>2</sup>) for one wire connection or #18 to #8 for two wire connection.
- Thermal magnetic overcurrent protection: three levels, categorized by B, C and D curves in direct relation to continuous rating of the device
- **B curve magnetic trip point:** 3 to 5 times the rated current, typically used for computers and electronic loads with very low inrush currents (PLC

wiring).

- **C curve magnetic trip point:** 5 to 10 times the rated current, typically used for small transformers, pilot devices, etc.
- **D curve magnetic trip point:** 10 to 20 times the rated current, typically used for transformers or devices with very high inductive loads.
- Trip Free Design: Protector cannot be defeated by holding the handle in the "ON" position.
- Module width of only 17.7 mm per pole
- Color coded status indicator window – Red = ON or Green = OFF
- P20 finger protection
- 35mm DIN-rail mountable, utilizing spring clip
- Captive screws cannot be lost
- Suitable for reverse feed applications

- CE File LVD 2006/95/EC
- IEC/EN 60898

- IEC/EN 60947-2

protective devices. In North America, most European Miniature Circuit Breakers are only UL recognized and CSA certified as "Supplementary Protectors", meaning they cannot be utilized as feeder or branch circuit protective devices per the local electrical codes (2008 NEC 240.10 and CEC Part 1 C22.1). This commonly restricts their use to applications where "closer" protection is desired than that offered by a branch circuit protection device.

Eaton FAZ Supplementary Protectors are

ideal for providing protection in many applications, including:

- Control power transformers (D curve)
- Relays
- Contactor coils
- PLC I/O points
- Lighting circuits
- Power supplies
- Computers
- Electronic equipment
- Control circuits

## Supplementary Protectors Sample Applications

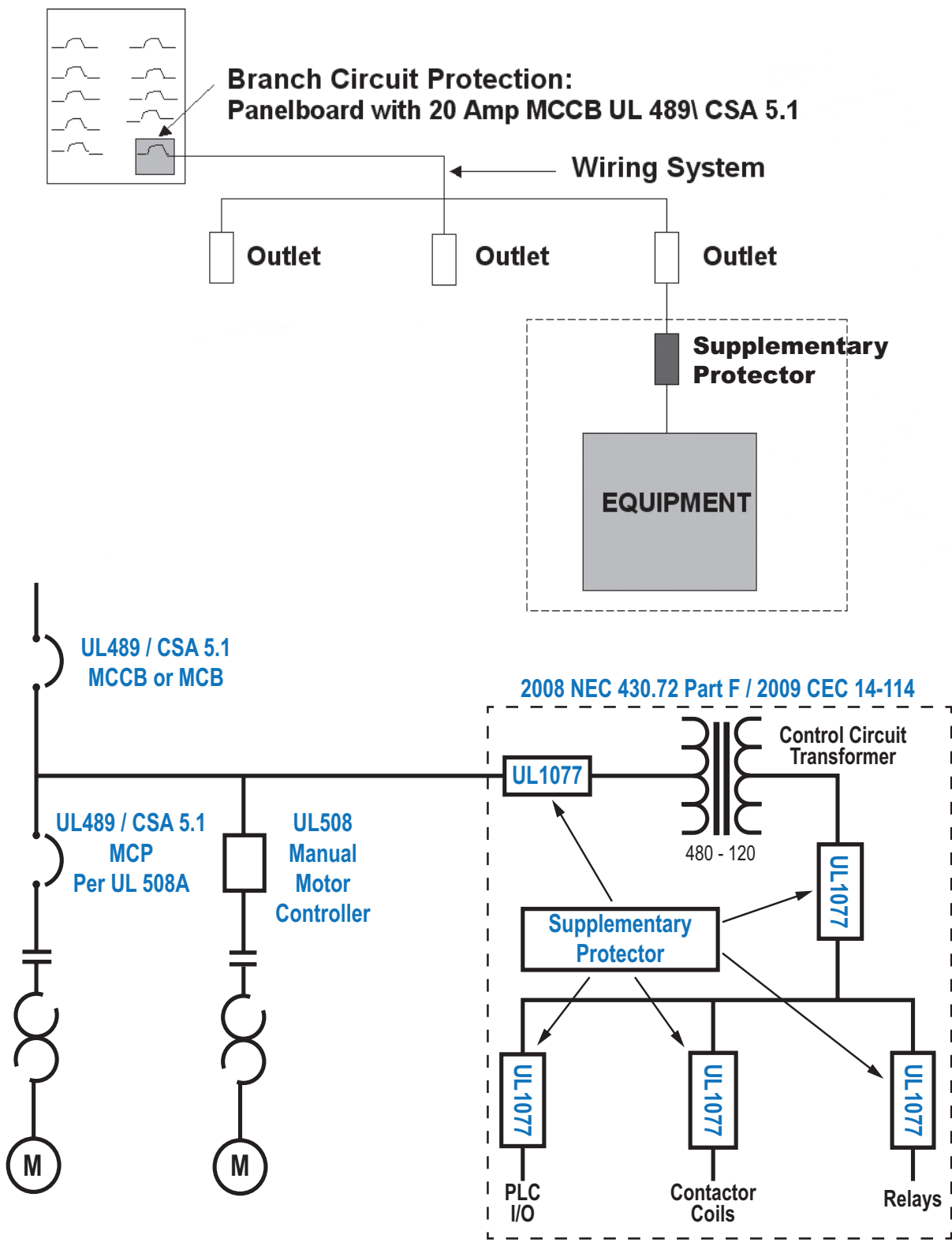

*Supplementary protectors are not to be used in feeder circuits or motor circuits. Use them only in applications where branch protection is already provided or is not required.*

# EATON FAZ Supplementary Protectors Selection Guide



**Single-Pole**

Note: Eaton product part numbers will contain a [.] instead of [ P ] and a [ / ] instead of a [ - ].  
Example: FAZ-C0P5-1-SP = FAZ-C0.5/1-SP

FAZ - Single-Pole Selection Guide						
Ampere Rating	B Curve Part Number	Price	C Curve Part Number	Price	D Curve Part Number	Price
0.5	-	-	<a href="#">FAZ-C0P5-1-SP</a>		<a href="#">FAZ-D0P5-1-SP</a>	
1	<a href="#">FAZ-B1-1-SP</a>	\$19.00	<a href="#">FAZ-C1-1-SP</a>	\$19.00	<a href="#">FAZ-D1-1-SP</a>	\$19.00
2	<a href="#">FAZ-B2-1-SP</a>		<a href="#">FAZ-C2-1-SP</a>		<a href="#">FAZ-D2-1-SP</a>	
3	<a href="#">FAZ-B3-1-SP</a>		<a href="#">FAZ-C3-1-SP</a>		<a href="#">FAZ-D3-1-SP</a>	
4	<a href="#">FAZ-B4-1-SP</a>		<a href="#">FAZ-C4-1-SP</a>		<a href="#">FAZ-D4-1-SP</a>	
5	<a href="#">FAZ-B5-1-SP</a>		<a href="#">FAZ-C5-1-SP</a>		<a href="#">FAZ-D5-1-SP</a>	
6	<a href="#">FAZ-B6-1-SP</a>		<a href="#">FAZ-C6-1-SP</a>		<a href="#">FAZ-D6-1-SP</a>	
7	<a href="#">FAZ-B7-1-SP</a>		<a href="#">FAZ-C7-1-SP</a>		<a href="#">FAZ-D7-1-SP</a>	
8	<a href="#">FAZ-B8-1-SP</a>		<a href="#">FAZ-C8-1-SP</a>		<a href="#">FAZ-D8-1-SP</a>	
10	<a href="#">FAZ-B10-1-SP</a>		<a href="#">FAZ-C10-1-SP</a>		<a href="#">FAZ-D10-1-SP</a>	
13	<a href="#">FAZ-B13-1-SP</a>		<a href="#">FAZ-C13-1-SP</a>		<a href="#">FAZ-D13-1-SP</a>	
15	<a href="#">FAZ-B15-1-SP</a>		<a href="#">FAZ-C15-1-SP</a>		<a href="#">FAZ-D15-1-SP</a>	
16	<a href="#">FAZ-B16-1-SP</a>		<a href="#">FAZ-C16-1-SP</a>		<a href="#">FAZ-D16-1-SP</a>	
20	<a href="#">FAZ-B20-1-SP</a>		<a href="#">FAZ-C20-1-SP</a>		<a href="#">FAZ-D20-1-SP</a>	
25	<a href="#">FAZ-B25-1-SP</a>		<a href="#">FAZ-C25-1-SP</a>		<a href="#">FAZ-D25-1-SP</a>	
30	<a href="#">FAZ-B30-1-SP</a>		<a href="#">FAZ-C30-1-SP</a>		<a href="#">FAZ-D30-1-SP</a>	
32	<a href="#">FAZ-B32-1-SP</a>		<a href="#">FAZ-C32-1-SP</a>		<a href="#">FAZ-D32-1-SP</a>	
40	<a href="#">FAZ-B40-1-SP</a>		<a href="#">FAZ-C40-1-SP</a>		<a href="#">FAZ-D40-1-SP</a>	
50	<a href="#">FAZ-B50-1-SP</a>		<a href="#">FAZ-C50-1-SP</a>		-	
63	<a href="#">FAZ-B63-1-SP</a>	<a href="#">FAZ-C63-1-SP</a>	-	-		



**Two-Pole**

Note: Eaton parts available for sale to North America locations only.

FAZ - Two-Pole Selection Guide						
Ampere Rating	B Curve Part Number	Price	C Curve Part Number	Price	D Curve Part Number	Price
0.5	-	-	<a href="#">FAZ-C0P5-2</a>		<a href="#">FAZ-D0P5-2</a>	
1	<a href="#">FAZ-B1-2</a>	\$36.50	<a href="#">FAZ-C1-2</a>	\$36.50	<a href="#">FAZ-D1-2</a>	\$36.50
2	<a href="#">FAZ-B2-2</a>		<a href="#">FAZ-C2-2</a>		<a href="#">FAZ-D2-2</a>	
3	<a href="#">FAZ-B3-2</a>		<a href="#">FAZ-C3-2</a>		<a href="#">FAZ-D3-2</a>	
4	<a href="#">FAZ-B4-2</a>		<a href="#">FAZ-C4-2</a>		<a href="#">FAZ-D4-2</a>	
5	<a href="#">FAZ-B5-2</a>		<a href="#">FAZ-C5-2</a>		<a href="#">FAZ-D5-2</a>	
6	<a href="#">FAZ-B6-2</a>		<a href="#">FAZ-C6-2</a>		<a href="#">FAZ-D6-2</a>	
7	<a href="#">FAZ-B7-2</a>		<a href="#">FAZ-C7-2</a>		<a href="#">FAZ-D7-2</a>	
8	<a href="#">FAZ-B8-2</a>		<a href="#">FAZ-C8-2</a>		<a href="#">FAZ-D8-2</a>	
10	<a href="#">FAZ-B10-2</a>		<a href="#">FAZ-C10-2</a>		<a href="#">FAZ-D10-2</a>	
13	<a href="#">FAZ-B13-2</a>		<a href="#">FAZ-C13-2</a>		<a href="#">FAZ-D13-2</a>	
15	<a href="#">FAZ-B15-2</a>		<a href="#">FAZ-C15-2</a>		<a href="#">FAZ-D15-2</a>	
16	<a href="#">FAZ-B16-2</a>		<a href="#">FAZ-C16-2</a>		<a href="#">FAZ-D16-2</a>	
20	<a href="#">FAZ-B20-2</a>		<a href="#">FAZ-C20-2</a>		<a href="#">FAZ-D20-2</a>	
25	<a href="#">FAZ-B25-2</a>		<a href="#">FAZ-C25-2</a>		<a href="#">FAZ-D25-2</a>	
30	<a href="#">FAZ-B30-2</a>		<a href="#">FAZ-C30-2</a>		<a href="#">FAZ-D30-2</a>	
32	<a href="#">FAZ-B32-2</a>		<a href="#">FAZ-C32-2</a>		<a href="#">FAZ-D32-2</a>	
40	<a href="#">FAZ-B40-2</a>		<a href="#">FAZ-C40-2</a>		<a href="#">FAZ-D40-2</a>	
50	<a href="#">FAZ-B50-2</a>		<a href="#">FAZ-C50-2</a>		-	
63	<a href="#">FAZ-B63-2</a>	<a href="#">FAZ-C63-2</a>	-	-		

# EATON FAZ Supplementary Protectors Selection Guide

FAZ - Three-Pole Selection Guide							
Ampere Rating	B Curve Part Number	Price	C Curve Part Number	Price	D Curve Part Number	Price	
0.5	-	-	<a href="#">FAZ-C0P5-3</a>		<a href="#">FAZ-D0P5-3</a>		
1	<a href="#">FAZ-B1-3</a>	\$49.50	<a href="#">FAZ-C1-3</a>	\$49.50	<a href="#">FAZ-D1-3</a>	\$49.50	
2	<a href="#">FAZ-B2-3</a>		<a href="#">FAZ-C2-3</a>		<a href="#">FAZ-D2-3</a>		
3	<a href="#">FAZ-B3-3</a>		<a href="#">FAZ-C3-3</a>		<a href="#">FAZ-D3-3</a>		
4	<a href="#">FAZ-B4-3</a>		<a href="#">FAZ-C4-3</a>		<a href="#">FAZ-D4-3</a>		
5	<a href="#">FAZ-B5-3</a>		<a href="#">FAZ-C5-3</a>		<a href="#">FAZ-D5-3</a>		
6	<a href="#">FAZ-B6-3</a>		<a href="#">FAZ-C6-3</a>		<a href="#">FAZ-D6-3</a>		
7	<a href="#">FAZ-B7-3</a>		<a href="#">FAZ-C7-3</a>		<a href="#">FAZ-D7-3</a>		
8	<a href="#">FAZ-B8-3</a>		<a href="#">FAZ-C8-3</a>		<a href="#">FAZ-D8-3</a>		
10	<a href="#">FAZ-B10-3</a>		<a href="#">FAZ-C10-3</a>		<a href="#">FAZ-D10-3</a>		
13	<a href="#">FAZ-B13-3</a>		<a href="#">FAZ-C13-3</a>		<a href="#">FAZ-D13-3</a>		
15	<a href="#">FAZ-B15-3</a>		<a href="#">FAZ-C15-3</a>		<a href="#">FAZ-D15-3</a>		
16	<a href="#">FAZ-B16-3</a>		<a href="#">FAZ-C16-3</a>		<a href="#">FAZ-D16-3</a>		
20	<a href="#">FAZ-B20-3</a>		<a href="#">FAZ-C20-3</a>		<a href="#">FAZ-D20-3</a>		
25	<a href="#">FAZ-B25-3</a>		<a href="#">FAZ-C25-3</a>		<a href="#">FAZ-D25-3</a>		
30	<a href="#">FAZ-B30-3</a>		<a href="#">FAZ-C30-3</a>		<a href="#">FAZ-D30-3</a>		
32	<a href="#">FAZ-B32-3</a>		<a href="#">FAZ-C32-3</a>		<a href="#">FAZ-D32-3</a>		
40	<a href="#">FAZ-B40-3</a>		<a href="#">FAZ-C40-3</a>		<a href="#">FAZ-D40-3</a>		
50	<a href="#">FAZ-B50-3</a>		<a href="#">FAZ-C50-3</a>		-		-
63	<a href="#">FAZ-B63-3</a>		<a href="#">FAZ-C63-3</a>		-		-



Three-Pole

Note: Eaton product part numbers will contain a [.] instead of [ P ] and a [ / ] instead of a [ - ].  
Example: FAZ-C0P5-3 = FAZ-C0.5/3



# EATON FAZ Series Technical Specifications

UL 1077 Supplementary Protectors – UL/CSA				
		B Curve	C Curve	D Curve
<b>Short Circuit Trip Response</b>		3 - 5 $I_n$	5 - 10 $I_n$	10 - 20 $I_n$
<b>Current Range</b>		1 - 63 A	0.5 - 63 A	0.5 - 40 A
<b>Maximum Voltage Ratings UL / CSA</b>	1 pole	277VAC, 48VDC		
	2 pole / 3 pole	480Y / 277VAC*		
	2 poles in series	96VDC Max		
<b>Thermal Tripping Characteristics</b>	1 pole	1.35 $I_n$ @ 40°C		
	Multi-pole	1.45 $I_n$ @ 40°C		
<b>Interrupting Ratings (@ maximum voltage)</b>	1 pole	10kA (5kA for 40 - 63 A)	5kA	
		10kA @ 48VDC		
	2 pole	10kA (5kA for 40 - 63 A)		5kA
	3 pole	10kA @ 96VDC		
2 poles in series	10kA @ 96VDC			
<b>Agency Approvals</b>		File E177451, UL 1077, File 204453 CSA 22.2 No. 235, CE		

Note: To obtain the most current agency approval information, see the Agency Approval Checklist section on the specific part number's web page.

IEC/EN 60947-2 Miniature Circuit Breaker				
		B Curve	C Curve	D Curve
<b>Short Circuit Trip Response</b>		3 - 5 $I_n$	5 - 10 $I_n$	10 - 20 $I_n$
<b>Current Range</b>		1 - 63 A	0.5 - 63 A	0.5 - 63 A
<b>Maximum Voltage Ratings - IEC/EN 60947-2</b>	1 pole	240VAC, 48VDC		
	2 pole / 3 pole	240/415 VAC		
	2 poles in series	96VDC		
<b>Thermal Tripping Characteristics</b>	1 pole	> 1 hour @ 1.05 $I_n$		
	Multi-pole	< 1 hour @ 1.3 $I_n$		
<b>Interrupt Ratings (At Max Voltage)</b>		15kA		
<b>Operational Switching Capacity</b>		7.5 kA		
<b>Max. Back-up Fuse</b>		125A gL/gG		
<b>Rated impulse withstand - <math>U_{imp}</math></b>		4000VAC		
<b>Rated insulation voltage - <math>U_i</math></b>		440VAC		

## General Specifications

<b>Selectivity Class</b>	3		
<b>Lifespan</b>	>10,000 (1 operation = ON/OFF)		
<b>Operating Temperature</b>	-40 to +167°F (-40 to +75°C)		
<b>Storage Temperature</b>	-40 to +185°F (-40 to +85°C)		
<b>Shock (IEC68-2-22)</b>	10g - 120ms		
<b>Housing Material</b>	Nylon		
<b>Weight</b>	1 pole	0.28 lb (127g)	
	2 pole	0.54 lb (245g)	
	3 pole	0.84 lb (381g)	

## Mechanical Specifications

<b>Terminal Protection</b>	Finger and back-of-hand proof to IEC 536		
<b>Mounting Width Per Pole</b>	17.5 mm		
<b>Mounting</b>	IEC/EN 60715 top-hat rail, DIN rail		
<b>Degree of Protection</b>	IP20		
<b>Terminals Top and Bottom</b>	Twin-purpose terminals		
<b>Supply Connection</b>	Line or load side		
<b>Mounting Position</b>	Without limitation		

## Wire Size and Torque Setting

Ampere Rating	Conductor Size		Tightening Torque
0.5 - 63	1 wire	0.75 to 25mm <sup>2</sup>	21.2 lb·in (2.4 N·m)
	2 wires	0.75 to 10mm <sup>2</sup>	

\*A circuit breaker with a 480Y/277 VAC rating can be applied in a solidly grounded circuit where the nominal voltage of any conductor to ground does not exceed the lower value of the circuit breaker's rating (e.g., 277VAC) and the nominal voltage between any two conductors does not exceed its higher value (480VAC). These ratings typically can be found on protective devices such as molded-case circuit breakers and self-protected "Tune F" combination motor controllers.

# EATON FAZ Series Technical Data

Corrected values of the rated current dependent on the ambient temperature

Influence of the Ambient Temperature on the Thermal Tripping Behavior																	
Rated Current (Amps)	Ambient Temperature °C																
	-40	-30	-20	-10	0	10	20	30	35	40	45	50	55	60	65	70	75
0.50	0.64	0.62	0.60	0.58	0.56	0.54	0.52	0.50	0.49	0.48	0.47	0.46	0.45	0.44	0.43	0.42	0.41
1.00	1.30	1.20	1.20	1.20	1.10	1.10	1.00	1.00	0.99	0.97	0.95	0.93	0.90	0.89	0.87	0.85	0.83
2.00	2.60	2.50	2.40	2.30	2.20	2.20	2.10	2.00	2.00	1.90	1.90	1.90	1.80	1.80	1.70	1.70	1.70
3.00	3.80	3.70	3.60	3.50	3.40	3.30	3.10	3.00	3.00	2.90	2.80	2.80	2.70	2.70	2.60	2.50	2.50
4.00	5.10	5.00	4.80	4.70	4.50	4.30	4.20	4.00	3.90	3.90	3.80	3.70	3.60	3.50	3.50	3.40	3.30
5.00	6.40	6.20	6.00	5.80	5.60	5.40	5.20	5.00	4.90	4.80	4.70	4.60	4.50	4.40	4.30	4.20	4.10
6.00	7.70	7.50	7.20	7.00	6.70	6.50	6.30	6.00	5.90	5.80	5.70	5.60	5.40	5.30	5.20	5.10	5.00
7.00	9.00	8.70	8.40	8.20	7.80	7.60	7.40	7.00	6.90	6.80	6.70	6.50	6.30	6.20	6.10	6.00	5.80
8.00	10.20	9.90	9.60	9.30	9.00	8.70	8.40	8.00	7.90	7.70	7.60	7.40	7.20	7.10	6.90	6.80	6.60
10.00	13.00	12.00	12.00	12.00	11.00	11.00	10.00	10.00	9.90	9.70	9.50	9.30	9.00	8.90	8.70	8.50	8.30
13.00	17.00	16.00	16.00	15.00	15.00	14.00	14.00	13.00	13.00	13.00	12.00	12.00	12.00	12.00	11.00	11.00	11.00
15.00	19.00	19.00	18.00	17.00	17.00	16.00	16.00	15.00	15.00	15.00	14.00	14.00	14.00	13.00	13.00	13.00	12.00
16.00	20.00	20.00	19.00	19.00	18.00	17.00	17.00	16.00	16.00	15.00	15.00	15.00	14.00	14.00	14.00	14.00	13.00
20.00	26.00	25.00	24.00	23.00	22.00	22.00	21.00	20.00	20.00	19.00	19.00	19.00	18.00	18.00	17.00	17.00	17.00
25.00	32.00	31.00	30.00	29.00	28.00	27.00	26.00	25.00	25.00	24.00	24.00	23.00	23.00	22.00	22.00	21.00	21.00
32.00	41.00	40.00	38.00	37.00	36.00	35.00	33.00	32.00	32.00	31.00	30.00	30.00	29.00	28.00	28.00	27.00	26.00
40.00	51.00	50.00	48.00	47.00	45.00	43.00	42.00	40.00	39.00	39.00	38.00	37.00	36.00	35.00	35.00	34.00	33.00
50.00	64.00	62.00	60.00	58.00	56.00	54.00	52.00	50.00	49.00	48.00	47.00	46.00	45.00	44.00	43.00	42.00	41.00
63.00	81.00	78.00	76.00	73.00	71.00	68.00	66.00	63.00	62.00	61.00	60.00	58.00	57.00	56.00	55.00	53.00	52.00

Influence of the mains system frequency on the tripping behavior IMA of the instantaneous release

Influence of the Mains Frequency							
Mains Frequency <i>f</i> (Hz)	16 2/3	50	60	100	200	300	400
$I_{MA}(f) / I_{MA}(50\text{Hz})$ [%]	91	100	101	106	115	134	141

Load Carrying Capacity of Adjoining Supplementary Protectors

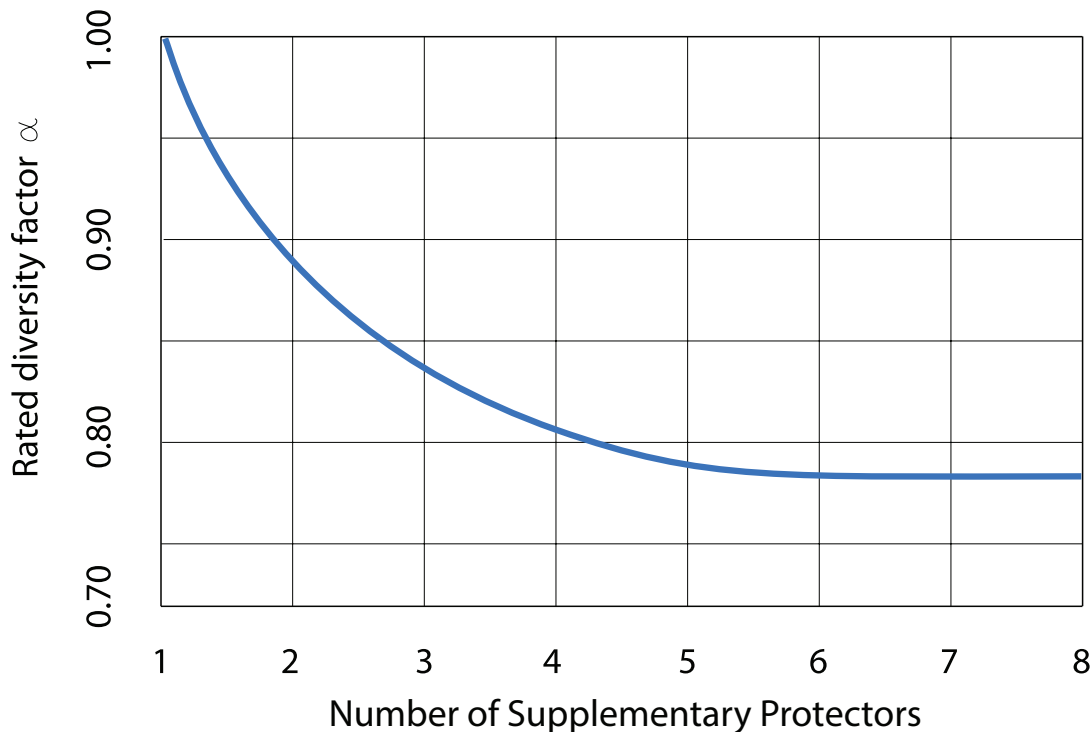

# EATON FAZ Series Technical Data

## Characteristic Curves

- The X axis shows the prospective short-circuit current levels.
- The Y axis indicates the actual let-through values at those prospective fault ratings for each FAZ device plotted.

As can be interpreted from the bend in the plotted curves, each device acts to limit the damaging let-through energy (and current) at those values of short-circuit current.

**Let-through energy  $I^2t$**   
Characteristic B and C

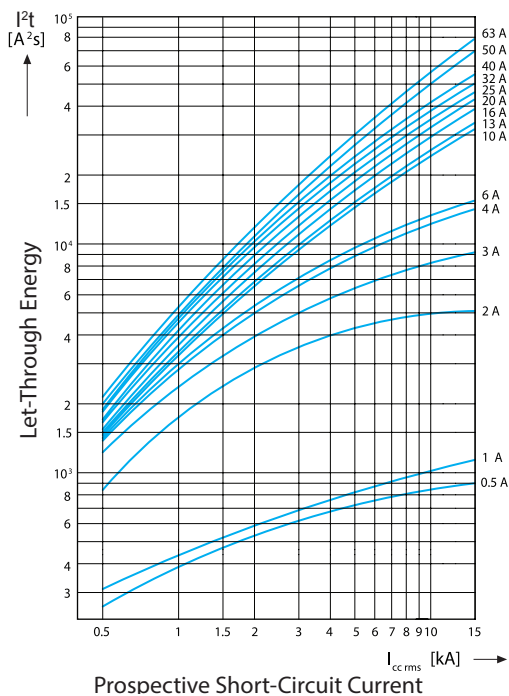

**Let-through current  $I$**   
Characteristic B and C

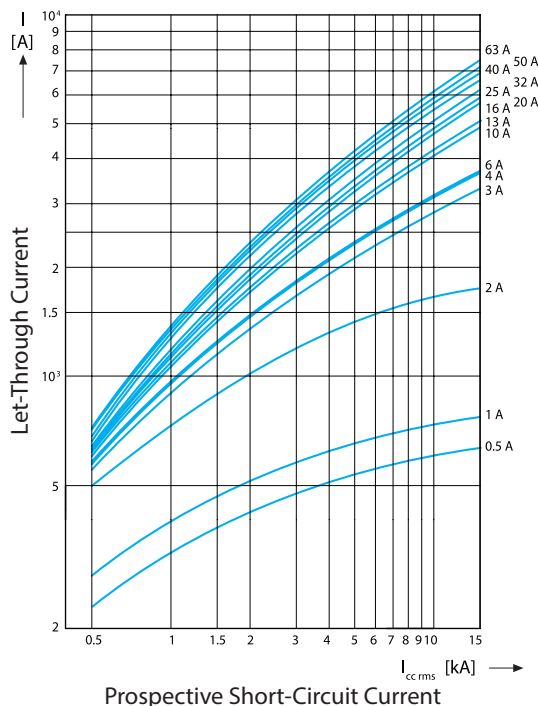

**Let-through energy  $I^2t$**   
Characteristic D

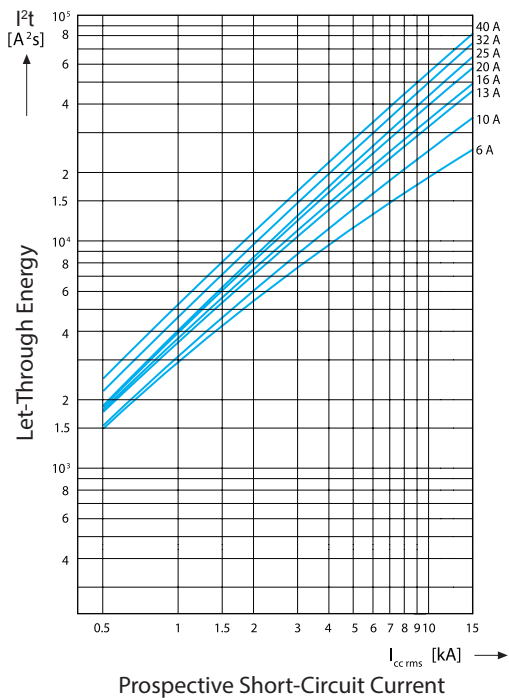

**Let-through current  $I$**   
Characteristic D

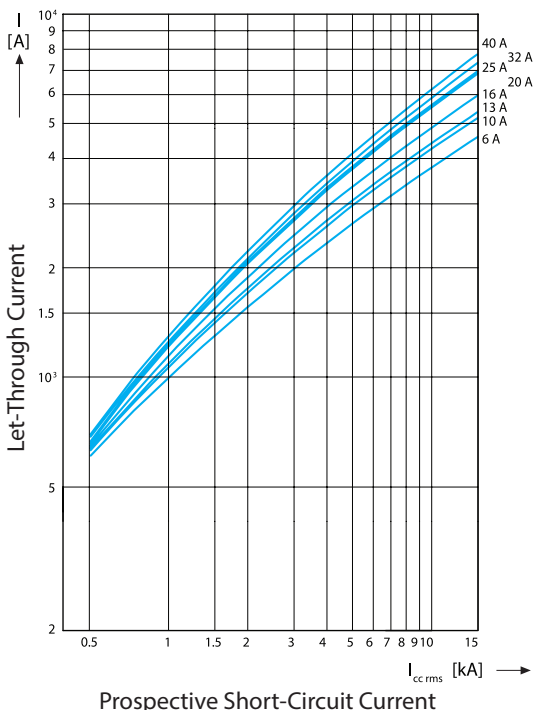



# EATON FAZ Series Technical Data

## Time-current characteristic

### Type B, C and D

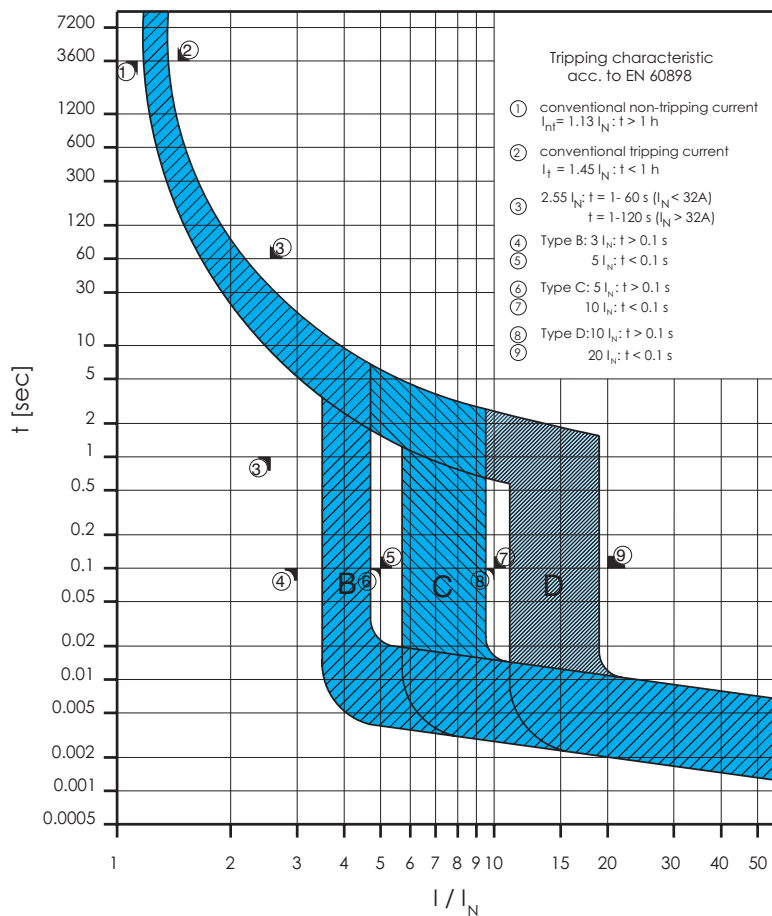

## FAZ Supplementary Protector Dimensions

in [mm]

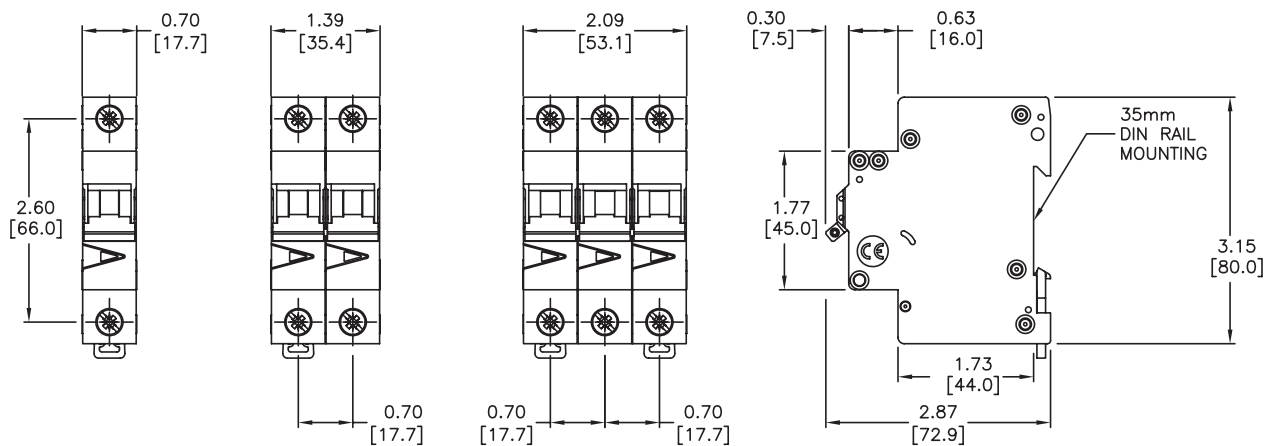

Please see our website [www.AutomationDirect.com](http://www.AutomationDirect.com) for complete engineering drawings. Dimensions are approximate. Not for construction purposes.

# EATON FAZ Series Accessories

## Field Mountable Accessories

- Auxiliary switch
- Alarm switch
- Shunt trip
- No tools required for mounting

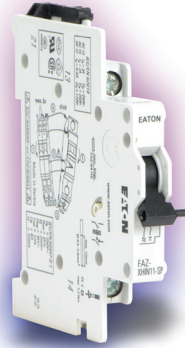

**FAZ-XHIN11-SP**  
Auxiliary Contact

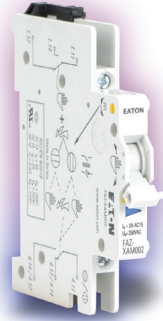

**FAZ-XAM002**  
Alarm/Aux Contact



**FAZ-XAA-C12-110V**  
**FAZ-XAA-C110-415V**  
Shunt Trip

FAZ Series Auxiliary Contacts and Shunt Trip Release					
Part Number	Description	Contacts	Module Width	Module Weight	Price
<b>FAZ-XHIN11-SP</b>	1 NO / 1 NC Installs on left side of FAZ or shunt trip Maximum one per FAZ (1077) device Switches when FAZ is tripped electrically or manually	(1) DPST	0.35 in [8.9 mm]	0.15 lb [68g]	\$35.00
<b>FAZ-XAM002</b>	Small selector screw changes mode Two form C (one set changeover) contacts Installs on left side of FAZ or shunt trip Auxiliary contacts switch when FAZ is tripped electrically or manually Trip indicating contact switches only when FAZ is tripped electrically	(2) Form C Contacts SPDT			
Part Number	Description	Trip Voltage	Module Width	Module Weight	Price
<b>FAZ-XAA-C110-415V</b>	Allows remote trip of FAZ Installs on left side of FAZ	110 - 415 VAC 110 - 230 VDC	0.69 in [17.5 mm]	0.28 lb [127g]	\$62.00
<b>FAZ-XAA-C12-110V</b>		12 - 110 VAC 12 - 60 VDC			

Auxiliary Contacts and Voltage Trips Technical Specifications							
Part Number	Circuit Diagram	Electrical Characteristics	Mechanical Characteristics	Wire Size (Solid and Stranded)		Tightening Torque	
				mm <sup>2</sup>	AWG	N-m	lb-in
<b>FAZ-XHIN11-SP</b>		Rated for general use 2A at 230/240 VAC 0.5 A at 110/120 VDC rated frequency 50/60 Hz	FAZ mounting, IP40 protection, IEC 536 protection against electric shock, lift terminals	0.5 - 2.5	18 - 14	0.8 - 1.0	7.1 - 9.0
<b>FAZ-XAM002</b>	See FAZ-XAM002 diagrams on dimensions page	1 SPDT auxiliary contact and 1 SPDT alarm contact that can be configured and used as an auxiliary contact, rated for general use, 2A at 230/240 VAC, 0.5 A at 110/120 VDC, rated frequency 50/60 Hz	FAZ mounting, IP40 protection, IEC 536 protection against electric shock, lift terminals				
<b>FAZ-XAA-C110-415V</b>		110 - 415 VAC, 110 - 230 VDC operating range, max inrush current 2.1 A (AC) / 1A (DC), rated frequency 50/60 Hz	IEC/EN 30715 top-hat rail or DIN rail mounting, IP40 protection, IEC 536 protection against electric shock, twin-purpose terminals	1 - 2.5	18 - 12	2.4	21.2
<b>FAZ-XAA-C12-110V</b>		12 - 110 VAC, 12 - 60 VDC operating range, maximum inrush current 15A (AC) / 21A (DC), rated frequency 50/60 Hz					

## Allowable Combinations of Accessories

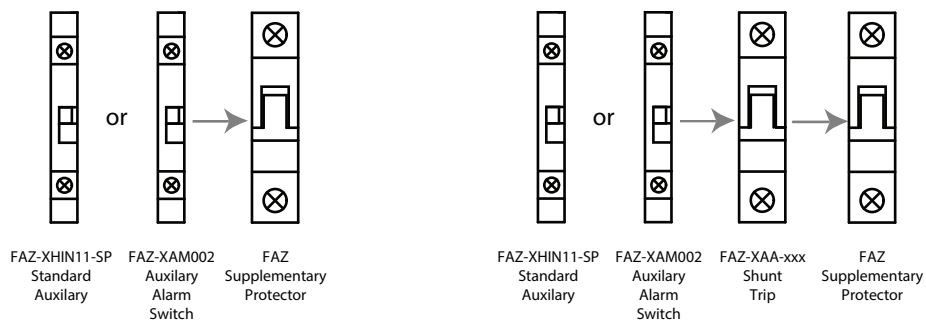

# EATON FAZ Series Accessories

## Protective Accessories

FAZ Series Protective Accessories			
Part Number	Description	Quantity	Price
<b>ZIS-SPE-1TE-3</b>	Lockout attachment for Eaton FAZ series supplementary protectors and FAZ mini circuit breakers, suitable to prevent unauthorized activation of a de-energized circuit, accepts lock shackles up to 9/32 in. (7.1 mm) in diameter	3 per pack	\$43.00
<b>BBIP-5</b>	Busbar protection shroud, covers up to 5 unused terminals (break off unused pieces to size), for use with Eaton BBUL series busbar.	10 per pack	\$69.00
<b>BBIP-5-5</b>		5 per pack	\$42.00

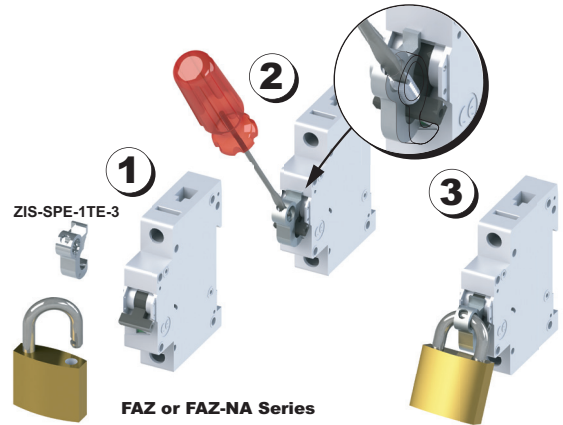

**ZIS-SPE-1TE-3**  
Lockout Attachment

## Busbar System

Without auxiliary contacts

BBUL Series Busbars for use with FAZ Series Supplementary Protectors				
	Description	Rated Operational Current	Qty	Price
<b>BBUL25-1P-1M57-SP</b>	Busbar, 1 pole, 57-position, 480VAC	100A, fed from end	1	\$58.00
<b>BBUL25-2P-2M56-SP</b>	Busbar, 2 pole, 56-position, 480VAC		1	\$107.00
<b>BBUL25-3P-3M57-SP</b>	Busbar, 3 pole, 57-position, 480VAC		1	\$162.00

Busbar Accessories			
	Description	Qty	Price
<b>BBUL-EC-1</b>	Busbar end cover for use with 1-pole Eaton BBUL series busbar.	10	\$15.50
<b>BBUL-EC-1-2</b>		2	\$6.25
<b>BBEV-EC-3</b>	Busbar cover end for use with 2-pole and 3-pole Eaton BBUL series busbar.	10	\$22.00
<b>BBEV-EC-3-2</b>		2	\$6.00
<b>BBUL-TEPA-35-1</b>	Busbar terminal lug, connects wiring to busbar system, for use with 1-pole Eaton BBUL series busbar, accepts 10AWG to 1/0 AWG copper wire, 115A, 1000V AC/DC.	1	\$19.00
<b>BBUL-TEPA-35-3</b>		3	\$52.00
<b>BBUL-TEP-35-1</b>	Busbar terminal lug, connects wiring to busbar system, for use with 2-pole and 3-pole Eaton BBUL series busbar, accepts 10AWG to 1/0 AWG copper wire, 115A, 1000V AC/DC.	1	\$19.00
<b>BBUL-TEP-35-3</b>		3	\$52.00

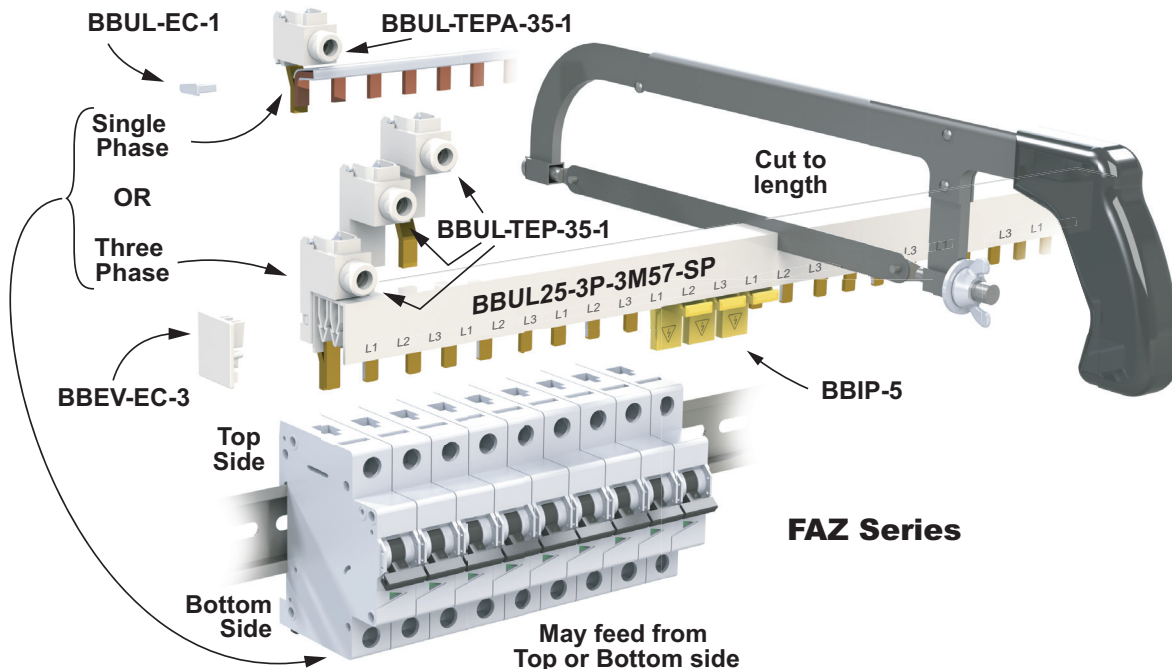

# FAZ Series Accessories

## Accessories Dimensions

in [mm]

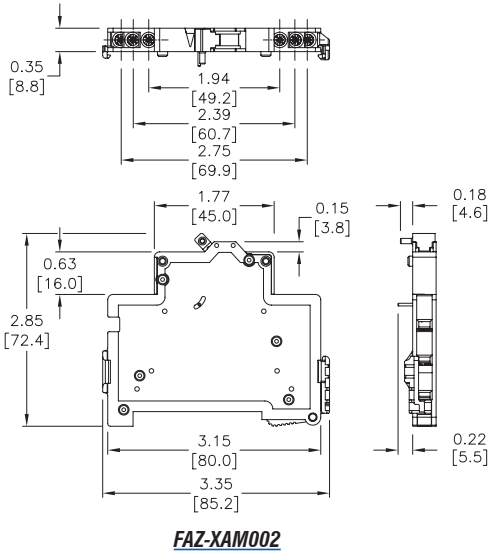

**FAZ-XAM002**

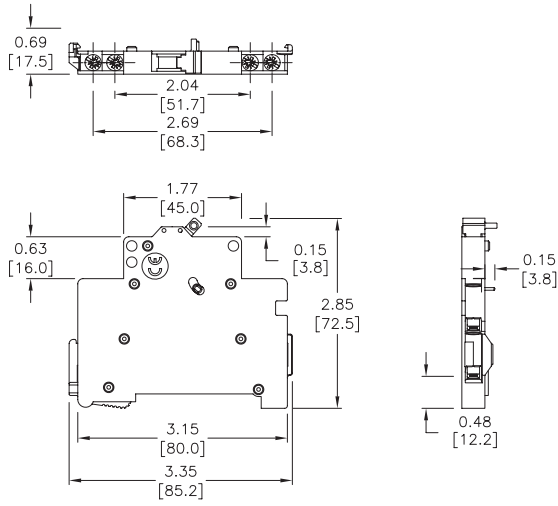

**FAZ-XHIN11-SP**

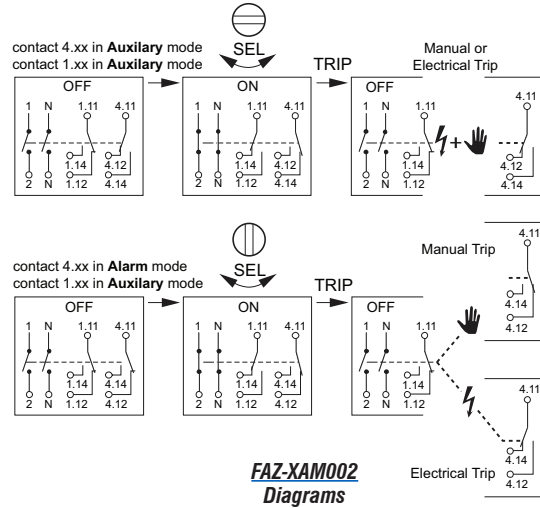

**FAZ-XAM002  
Diagrams**

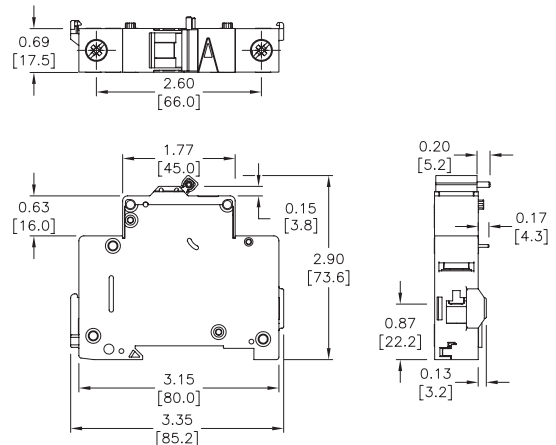

**FAZ-XAA-C-xxx**

## FAZ Series Miniature Circuit Breakers

Connection Diagrams

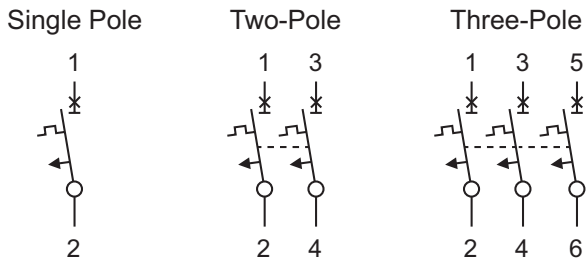

## Busbar Connection Diagrams

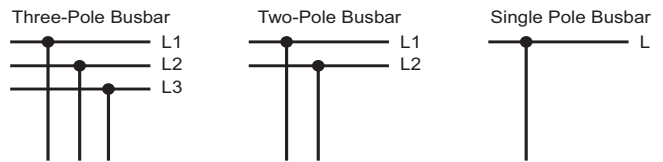

Please see our website [www.AutomationDirect.com](http://www.AutomationDirect.com) for complete engineering drawings.

# EATON FAZ Series Accessories

## Accessories Dimensions

in [mm]

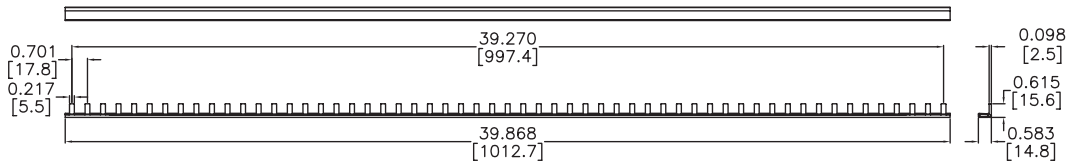

**BBUL25-1P-1M57-SP**

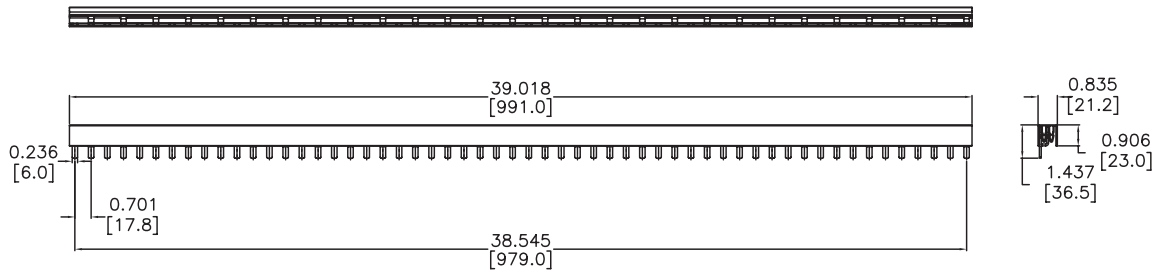

**BBUL25-2P-2M56-SP**

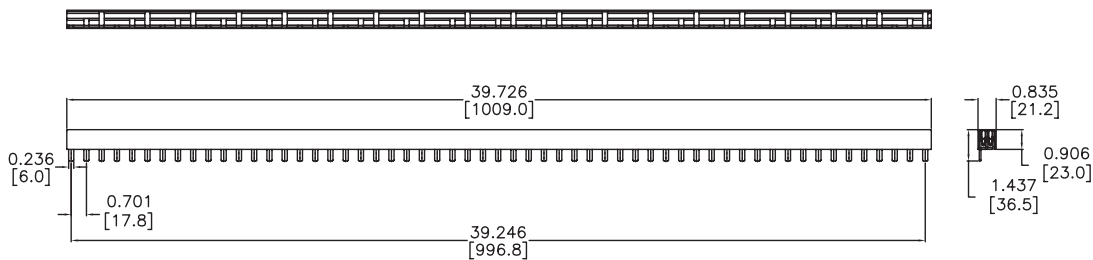

**BBUL25-3P-3M57-SP**

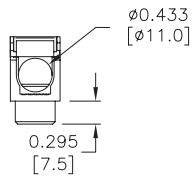

**BBUL-TEP-35-1**

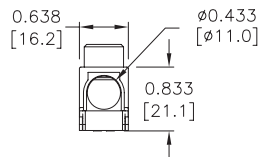

**BBUL-TEPA-35-1**

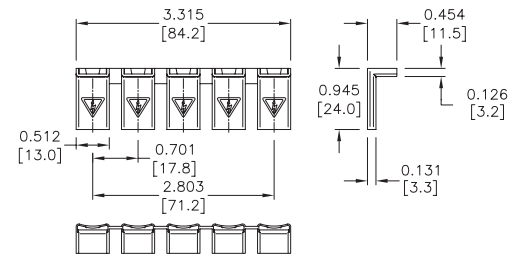
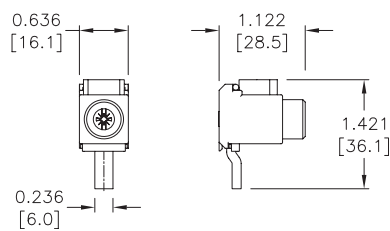
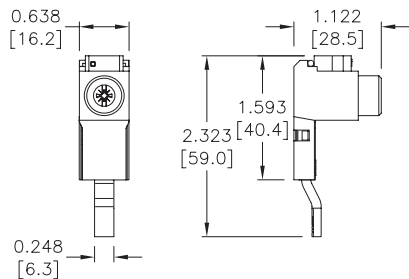

**BBIP-5**

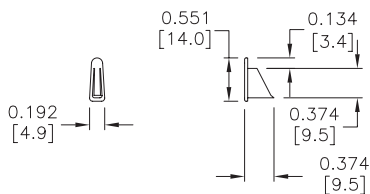

**BBUL-EC-1**

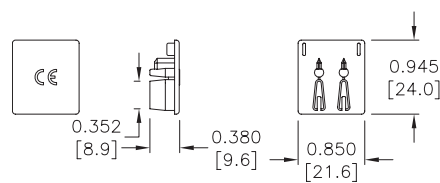

**BBEV-EC-3**

Please see our website [www.AutomationDirect.com](http://www.AutomationDirect.com) for complete engineering drawings.

# UL 489 or UL 1077? What are your Circuit Protection Requirements?

An understanding of circuit types and circuit protection products is critical to ensure their proper application.  
See NEC Sections 100, 430 and 409 for definitions.

The proper sizing of an overcurrent protection device is the responsibility of the customer and should be determined using the application standards of the NEC (National Electric Code), CEC (Canadian Electrical Code) or other applicable standards. Per fine print note of 2008 NEC Section 100 "A current in excess of rating may be accommodated by certain equipment and conductors for a given set of conditions. Therefore, the rules for overcurrent protection are specific for particular situations."

## UL 489

### Branch Protection

## UL 1077

### Supplementary Protection



### What You Need to Know and Look For In Specifications

Certifications – Standards – Acceptance

#### UL 489 Branch Protection

- UL 489 Listed or Recognized
- CSA C22.2 No. 5
- International ratings available depending on breaker type

#### UL 1077 Supplementary Protection

- UL Recognized under UL 1077
- CSA 22.2 No. 285
- IEC 60947-2 or IEC 898

#### Function

- Opens automatically on Overload and Short Circuit when properly applied within its ratings
- Protects wire and cable against Overload and Short Circuit

- Opens automatically on Overload and Short Circuit
- Provides additional equipment protection where branch circuit protection is already provided or not required
- Not suitable for the protection of branch circuit conductors

#### Applications

- Branch circuit protection in control panels, panelboards, switchboards and motor control centers
- Motor overload and motor short circuit protection (UL 489 Recognized motor circuit protectors) for control panels and motor control centers

- Used within appliances or other electrical equipment such as control circuits, control power transformers, relays, PLC I/O points and lighting circuits
- Ideal replacement for fuses that are applied as supplementary protection

#### Features

- Bolted down or DIN rail mounted
- External handle mechanisms available
- Field mounted accessories
- Stand alone branch circuit protection
- Various levels of protection (curve type)
- High voltage and interruption levels (up to 100 kAIC @ 480V)

- DIN rail mounted
- Field mounted accessories
- Various levels of protection (curve type)
- 10 kAIC @ 240 VAC
- 10 kAIC @ 277 VAC and 5 kAIC @ 480VAC
- 10 kAIC @ 48VDC

kAIC = thousands of Amps interrupt capacity

#### Summary

**A Supplementary Protector can't be used for Branch Circuit Protection.**  
Understanding the difference between Branch Circuit Protection and Supplementary Protection helps to ensure their proper use.



# UL 1077 Supplementary Protectors and UL 489 Circuit Breakers Application Guidelines

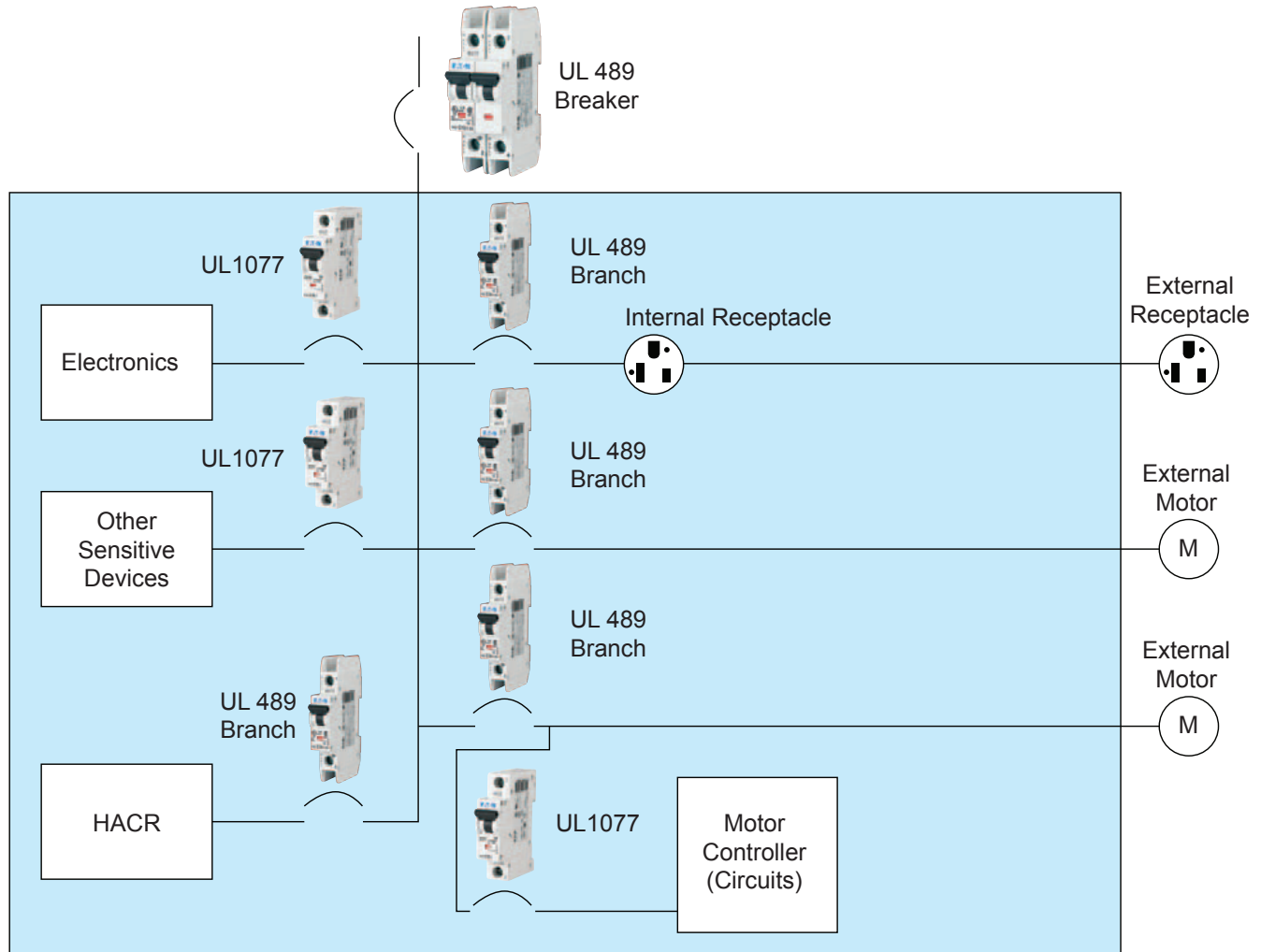

Example of UL 489 and UL 1077 Application

### **UL489 circuit breakers**

Used for branch circuit protection, internal/external receptacles, external motors and HACR equipment (heating, air conditioning and refrigeration).

### **UL1077 supplementary protectors**

Used for overcurrent protection within appliances or electrical equipment, where branch circuit protection is already provided or not required.

*Note: UL489 devices can be used in place of UL1077; UL1077 devices cannot be used in place of UL489.*