

# WDP Series Definite Purpose Contactors



## Features

- Rated current from 25-60A
- 1-, 2-, and 3-pole configurations at 25A, 30A, and 40A
- 3-pole configurations at 50A and 60A
- Enclosed coil standard for all 3-pole frame sizes
- Open coil standard for all 1- and 2-pole frame sizes
- Industry standard mounting plate provides easily accessible mounting holes
- Connection terminal box lug connections each with quick connect/disconnect terminals
- Coil is class B 266°F (130°C) insulation system with a wide range of voltages and 50/60 Hz ratings
- Double E magnet assembly provides optimal performance with reduced power consumption
- Base assembly made from high arc-resistant polyester and thermoset plastic
- Temperature range -40 to 158 °F (-40 to 70 °C)
- IP20 rating
- 5 kA SCCR with Fuse or Circuit Breaker:
  - 25A max fuse/CB 60A
  - 30A max fuse/CB 80A
  - 40A max fuse/CB 90A
  - 50A max fuse/CB 100A
  - 60A max fuse/CB 125A

## Applications

- Air conditioning
- Resistive heating
- Refrigeration equipment
- Motors
- Welding
- Pumps
- Power supplies
- Food service equipment
- Compressors

## Certifications

- UL 508 Recognized, File No. E330834
- IEC/EN 60947 Compliant
- Compliance to ARI-780 HVAC standards
- CSA file No. 266851



## Accessories

Multiple optional auxiliary contact blocks with 250 VAC/VDC or 600VAC max rating available:

- 1NO+1NC screw terminal
- 1NO+1NC quick connect
- 1NO+1NC quick connect microswitch
- 2NO+2NC quick connect microswitch

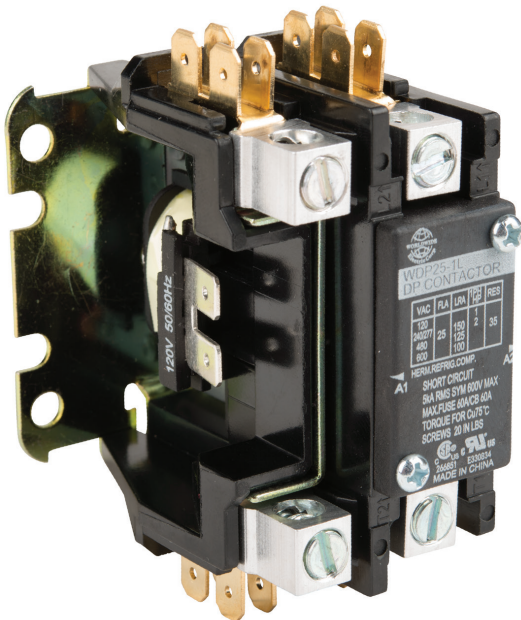

WDP 25 Series Contactor



WDP 50 Series Contactor

# WDP Series Definite Purpose Contactors



## Contactors Specifications

WDP Series 25-40 Amp DP Contactor Specifications																										
Model	Price	Qty.	Poles	FLA (A) 600VAC max <sup>1</sup>	Resistive Loads @600VAC (A)	Locked Rotor Amps (A)			Horsepower (hp)					Weight (lb)												
						240/ 277V	480V	600V	1-Phase		3-Phase															
									120V	240/277V	240/277V	480V	600V													
<a href="#">WDP25-1L-120</a>	\$12.00	1 ea.	1NO+Shunt	25	35	150	125	100	1	2	-	-	-	0.51												
<a href="#">WDP25-1L-230</a>	\$12.00																									
<a href="#">WDP25-2L-120</a>	\$10.50																									
<a href="#">WDP25-2L-230</a>	\$10.50																									
<a href="#">WDP25-3L-120</a>	\$18.50																									
<a href="#">WDP25-3L-230</a>	\$18.50																									
<a href="#">WDP30-1L-120</a>	\$12.50		2NO	32	40	200	150	120	2	3	-	-	-	0.64												
<a href="#">WDP30-1L-230</a>	\$12.50																									
<a href="#">WDP30-1L-24</a>	\$12.50																									
<a href="#">WDP30-2L-120</a>	\$12.00																									
<a href="#">WDP30-2L-230</a>	\$12.00																									
<a href="#">WDP30-2L-24</a>	\$12.00																									
<a href="#">WDP30-3L-120</a>	\$18.50		3NO	40	50	240	200	160	2	5	10	15	20	0.97												
<a href="#">WDP30-3L-230</a>	\$18.50																									
<a href="#">WDP30-3L-24</a>	\$18.50																									
<a href="#">WDP30-3L-480</a>	\$18.50																									
<a href="#">WDP40-1L-120</a>	\$13.50														1NO+Shunt	40	50	240	200	160	2	3	-	-	-	0.51
<a href="#">WDP40-1L-230</a>	\$13.50																									
<a href="#">WDP40-2L-120</a>	\$15.50																									
<a href="#">WDP40-2L-230</a>	\$15.50	2NO	40	50	240	200	160	3	7.5	10	20	25	0.97													
<a href="#">WDP40-3L-120</a>	\$24.50																									
<a href="#">WDP40-3L-230</a>	\$24.50																									
<a href="#">WDP40-3L-24</a>	\$24.50	3NO												40	50	240	200	160	3	7.5	10	20	25	0.97		
<a href="#">WDP40-3L-480</a>	\$24.50																									

Notes: 1-Full load amperage applies at 240/277, 480, and 600V.

WDP Series 50-60 Amp DP Contactor Specifications																
Model	Price	Qty.	Poles	FLA (A) 600VAC max <sup>1</sup>	Resistive Loads @600VAC (A)	Locked Rotor Amps (A)			Horsepower (hp)						Weight (lb)	
						240/ 277V	480V	600V	1-Phase			3-Phase				
									110/ 120V	200/ 208V	240/ 277V	200/ 208V	240/ 277V	480V		600V
<a href="#">WDP50-3L-120</a>	\$37.00	1 ea.	3NO	50	65	300	250	200	3	7.5	10	15	15	25	25	1.28
<a href="#">WDP50-3L-230</a>	\$37.00															
<a href="#">WDP50-3L-24</a>	\$37.00															
<a href="#">WDP60-3L-120</a>	\$61.00			60	75	360	300	240	5	7.5	10	25	25	30	30	
<a href="#">WDP60-3L-230</a>	\$61.00															
<a href="#">WDP60-3L-24</a>	\$61.00															

Notes: 1-Full load amperage applies at 240/277, 480, and 600V.

# WDP Series Definite Purpose Contactors



## Contactor Specifications, continued

WDP Series 25-60 Amp DP Contactor Specifications	
Mechanical Life	500,000 operations
Electrical Life	250,000 operations
Line and Load Terminals	#10-32 Screw/Box Lug
Mounting	Vertical or Horizontal
Operating Temperature	-40 to 70 °C (-40 to 158 °F)
Insulation System	Class B 266°F (130°C)
Agency Approvals	UL file #E330834, Standard UL 60947-1, CSA file #266851

Notes: Applies to all WDP series contactors.

## Terminal Specifications

WDP Series 25-60 Amp DP Contactor Terminal Specifications										
Model	Copper Cable AWG (mm <sup>2</sup> )				Coil	Tightening Torque in-lb (N•m)		Quick Connects <sup>1</sup>		
	Solid Wire w/Single Core		Flexible Stranded Wire			Main Circuit		Power Terminals	Coil Terminals	0.250 Standard
	Screw	Lug	Screw	Lug		Screw	Lug			
WDP25-1L Series	14-10 (2.5-6)		14-12 (2.5-6)	14-8 (2.5-10)	See note 2	20 (1.8-2)	40 (4-6)	Dual 0.250 QC (2)	Dual 0.250 QC <sup>2</sup>	Quad
WDP25-2L Series										Dual or Quad <sup>3</sup>
WDP25-3L Series										Dual
WDP30-1L Series	12-8 (4-10)			14-8 (2.5-10)		20 (1.8-2)	40 (4-6)	Dual 0.250 QC (2)	Dual 0.250 QC <sup>2</sup>	Quad
WDP30-2L Series										Dual or Quad <sup>3</sup>
WDP30-3L Series	16-8 (1.5-10)	14-8 (2.5-10)								Dual
WDP40-1L Series	2-8 (4-10)			12-8 (4-10)		20 (1.8-2)	40 (4-6)	Dual 0.250 QC (2)	Dual 0.250 QC <sup>2</sup>	Quad
WDP40-2L Series										Dual or Quad <sup>3</sup>
WDP40-3L Series	16-8 (1.5-10)									Dual
WDP50 Series	-	10-6 (6-16)	-	12-8 (4-10)				50 (4-7)	Dual 0.250 QC (2)	0.250 QC <sup>2</sup>
WDP60 Series	-	10-6 (6-16)	-	12-8 (4-10)			50 (4-7)	Dual 0.250 QC (2)	0.250 QC <sup>2</sup>	-

<sup>1</sup> Quick connects (size 6.3mm, female) may be purchased on the web store [www.automationdirect.com](http://www.automationdirect.com)  
<sup>2</sup> All coil connections are 0.25 inch quick-connect terminals only.  
<sup>3</sup> Quad is standard.

## Wiring Diagrams

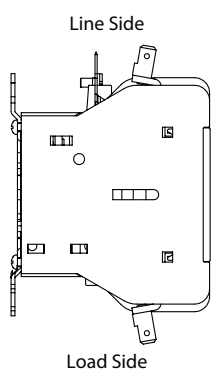

WDP25~40

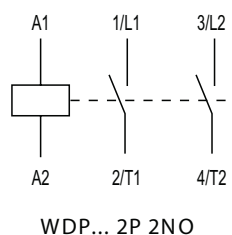
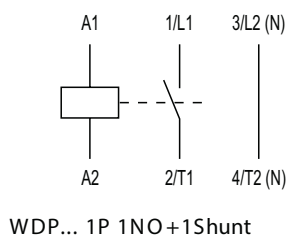

WDP25~60

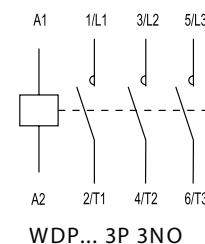

# WDP Series Definite Purpose Contactors



## Coil Specifications

WDP Series 25-60 Amp DP Contactor Coil Specifications							Pick-Up Voltage	Drop-Out Voltage
Model	Poles	Coil Voltage (50/60Hz VAC)	Power Consumption <sup>1</sup> (VA)					
			50Hz		60Hz			
			In-Rush	Sealed	In-Rush	Sealed		
<a href="#">WDP25-1L-120</a>	1 NO+Shunt	120	55	13	25	6.7	85-110% Us (see note 2)	20-65% Us (see note 2)
<a href="#">WDP25-1L-230</a>		230						
<a href="#">WDP25-2L-120</a>	2 NO	120	55	13	40	8.8		
<a href="#">WDP25-2L-230</a>		230						
<a href="#">WDP25-3L-120</a>	3 NO	120	51	12	47	9.3		
<a href="#">WDP25-3L-230</a>		230						
<a href="#">WDP30-1L-120</a>	1 NO+Shunt	120	55	13	25	6.7		
<a href="#">WDP30-1L-230</a>		230						
<a href="#">WDP30-1L-24</a>		24						
<a href="#">WDP30-2L-120</a>	2 NO	120	55	13	40	8.8		
<a href="#">WDP30-2L-230</a>		230						
<a href="#">WDP30-2L-24</a>		24						
<a href="#">WDP30-3L-120</a>	3 NO	120	51	12	47	9.3		
<a href="#">WDP30-3L-230</a>		230						
<a href="#">WDP30-3L-24</a>		24						
<a href="#">WDP30-3L-480</a>		480						
<a href="#">WDP40-1L-120</a>	1 NO+Shunt	120	55	13	25	6.7		
<a href="#">WDP40-1L-230</a>		230						
<a href="#">WDP40-2L-120</a>	2 NO	120	55	13	40	8.8		
<a href="#">WDP40-2L-230</a>		230						
<a href="#">WDP40-3L-120</a>	3 NO	120	51	12	47	9.3		
<a href="#">WDP40-3L-230</a>		230						
<a href="#">WDP40-3L-24</a>		24						
<a href="#">WDP40-3L-480</a>		480						
<a href="#">WDP50-3L-120</a>	3 NO	120	84	14	83	9.3		
<a href="#">WDP50-3L-230</a>		230						
<a href="#">WDP50-3L-24</a>		24						
<a href="#">WDP60-3L-120</a>		120						
<a href="#">WDP60-3L-230</a>		230						
<a href="#">WDP60-3L-24</a>	24							

<sup>1</sup> Power consumption is the same for 24, 120, 240, 277, and 480 VAC.

<sup>2</sup> Us = Rated control supply voltage, per UL 60947-1

# WDP Series Definite Purpose Contactors Accessories



WDP Series Accessories Selection Guide			
Model	Type	Contact Arrangement	Connection Type <sup>1</sup>
<a href="#"><u>WDPAXFC11</u></a>	Auxiliary Contact	1 NO+1 NC	Screw
<a href="#"><u>WDPAXFC11Q</u></a>		1 NO+1 NC	Quick Connect
<a href="#"><u>WDPAXFD11</u></a>	Microswitch (SPDT)	1 NO+1 NC	Quick Connect
<a href="#"><u>WDPAXFD22</u></a>		2 NO+2 NC	Quick Connect

WDP Series DP Contactors Accessories Specifications																	
Model	Price	For Use With	Mounting	Wiring	Current Ratings												
					Break (A)				Make (A)				Continuous (A)	125 or 250 VAC	120 VAC on Lamp Load	125 VDC	250 VDC
					120VAC	240VAC	480VAC	600VAC	120VAC	240VAC	480VAC	600VAC					
<a href="#"><u>WDPAXFC11</u></a>	\$15.50	WDP25-60 (3-Pole only)	Side mounted <sup>2</sup>	#6-32 screw terminal, wire range #14-22 AWG	3	1.50	0.75	0.60	30	15	7.5	6	5	10A, 1/3 hp	4A	1/2 A	1/4 A
<a href="#"><u>WDPAXFC11Q</u></a>	\$15.50			0.250 Quick Connection													
<a href="#"><u>WDPAXFD11</u></a>	\$15.50	WDP25-40 (3-Pole only)	One switch per side	0.250 Quick Connection													
<a href="#"><u>WDPAXFD22</u></a>	\$18.50		Two switches per side	0.250 Quick Connection													
<b>Agency Approvals</b>					UL file #E330834, Standard UL 60947-1												

<sup>1</sup> Quick connects (size 6.3mm, female) may be purchased on the web store [www.automationdirect.com](http://www.automationdirect.com)  
<sup>2</sup> Maximum of two may be mounted.

# WDP Series Definite Purpose Contactors



## Dimensions inches [mm]

### WDP Series 25-40A One Pole Contactors

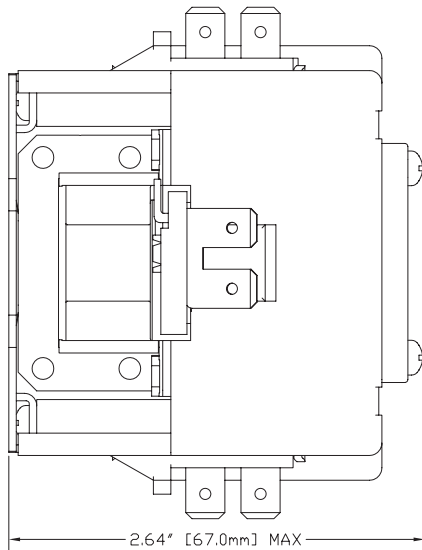

Side Detail

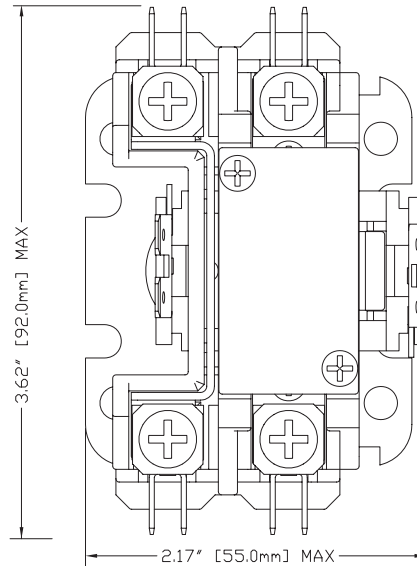

Front Detail

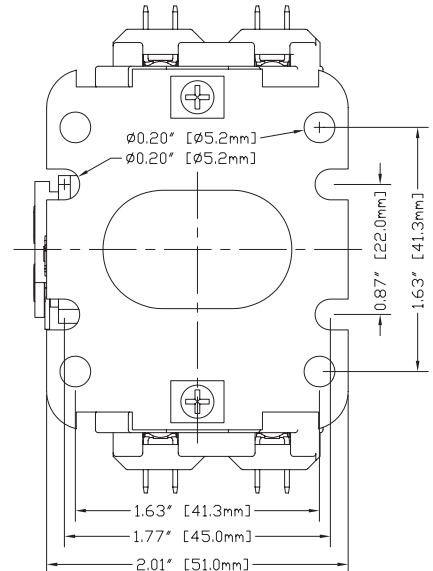

Base Detail

### WDP Series 25-40A Two Pole Contactors

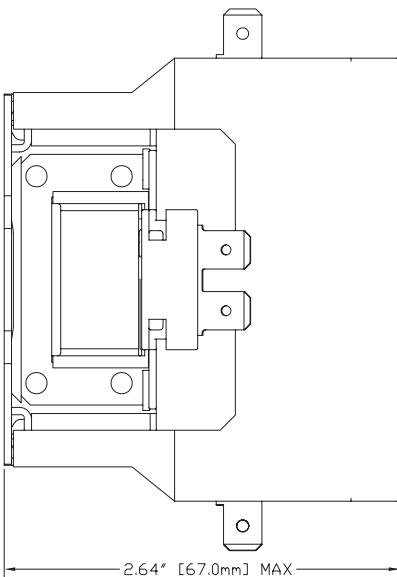

Side Detail

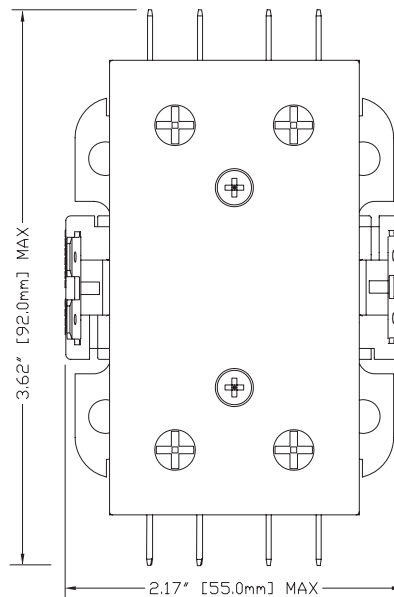

Front Detail

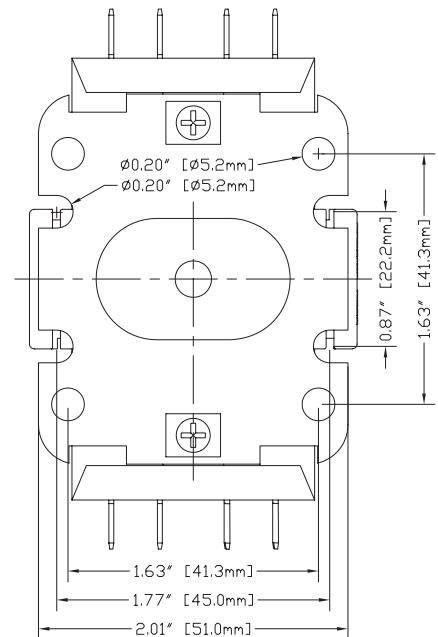

Base Detail

# WDP Series Definite Purpose Contactors



## Dimensions inches [mm]

### WDP Series 25-40A Three Pole Contactors

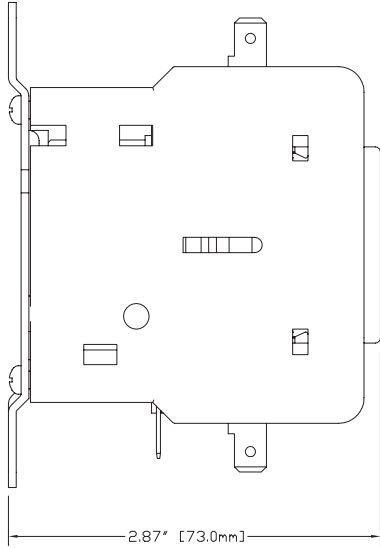

Side Detail

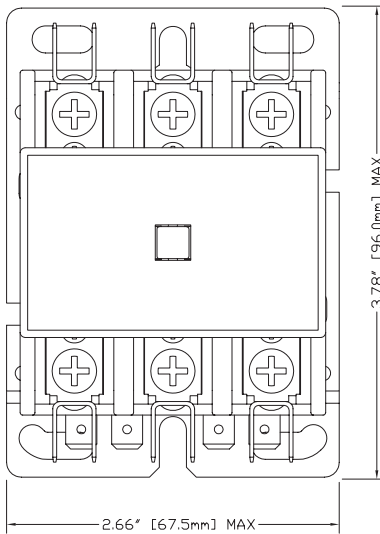

Front Detail

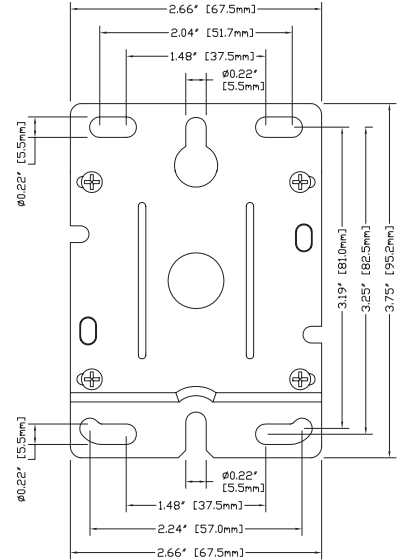

Base Detail

### WDP Series 50-60A Three Pole Contactors

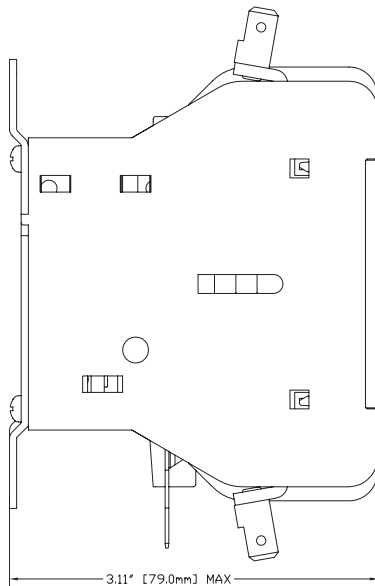

Side Detail

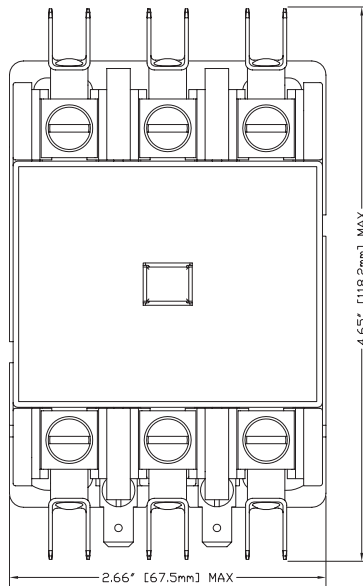

Front Detail

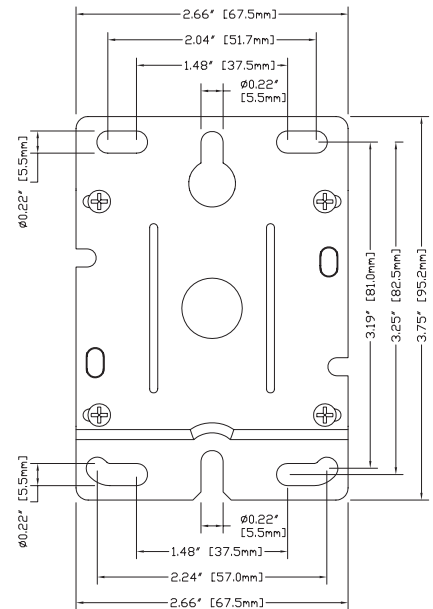

Base Detail

# WDP Series Definite Purpose Contactors Accessories



## Dimensions inches [mm]

### WDPAXFC11 Accessory

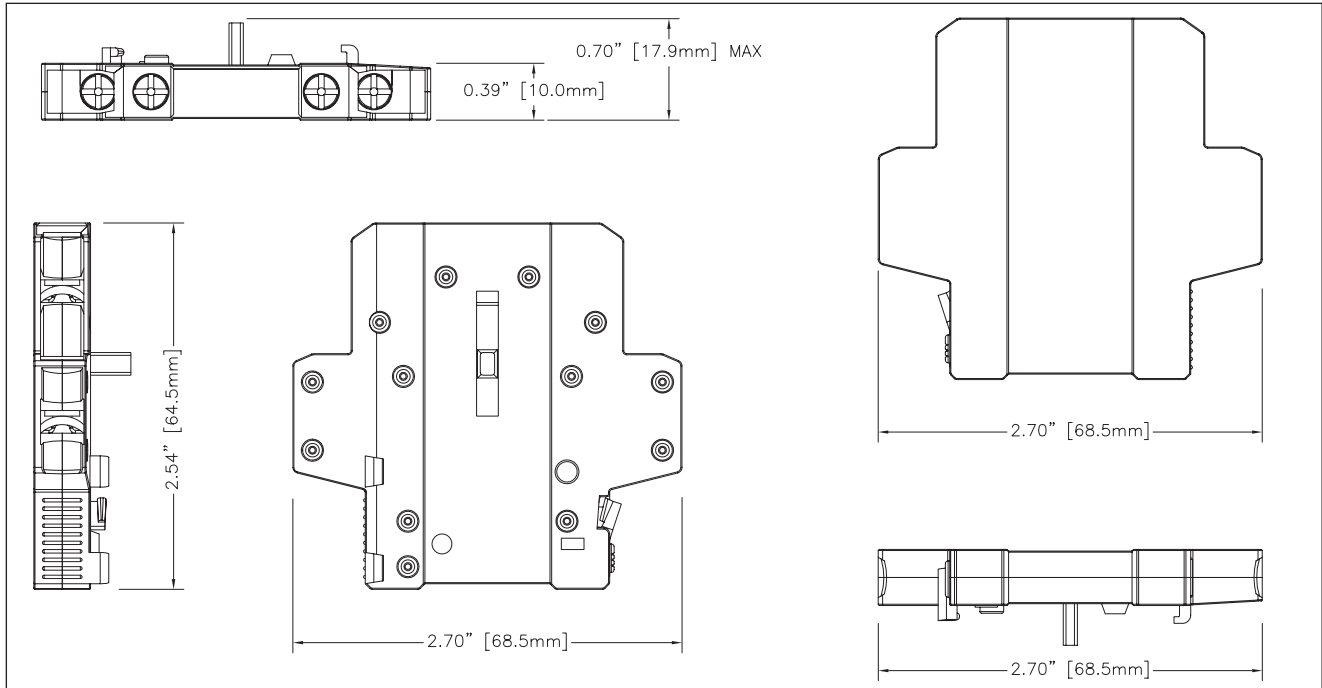

### WDPAXFC11Q Accessory

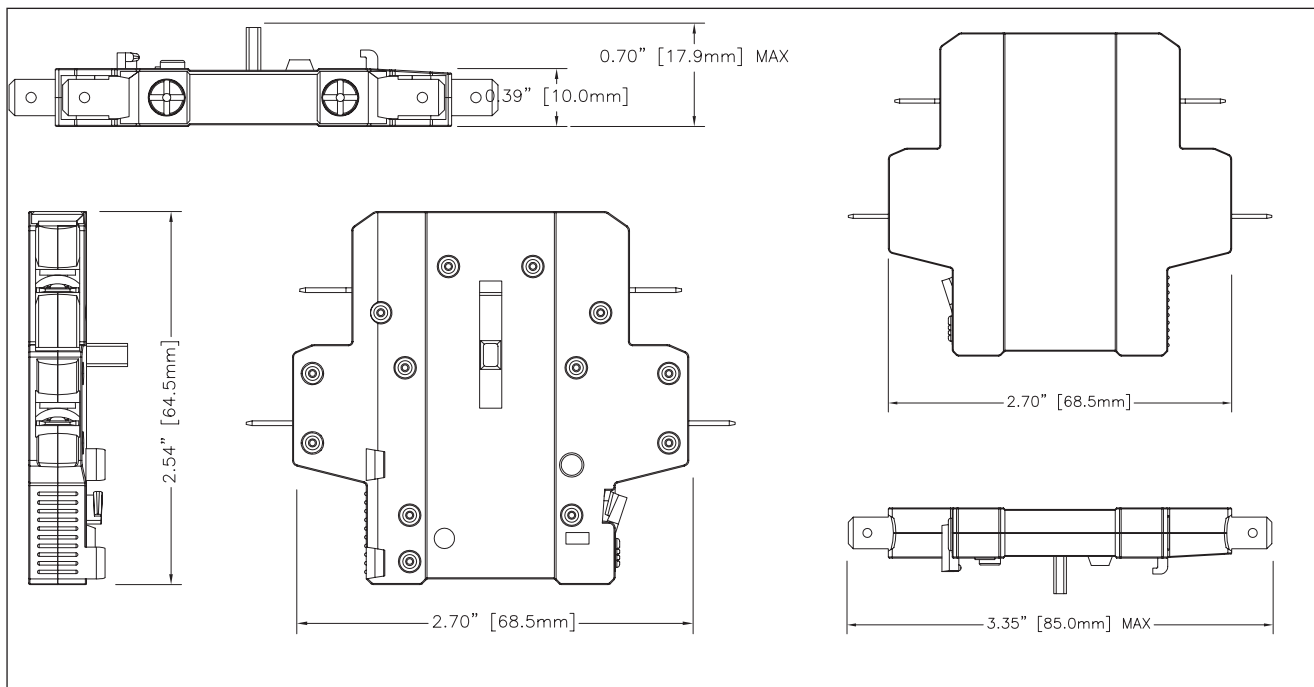



# WDP Series Definite Purpose Contactors Accessories



## Dimensions inches [mm]

### WDPAXFD11 Accessory

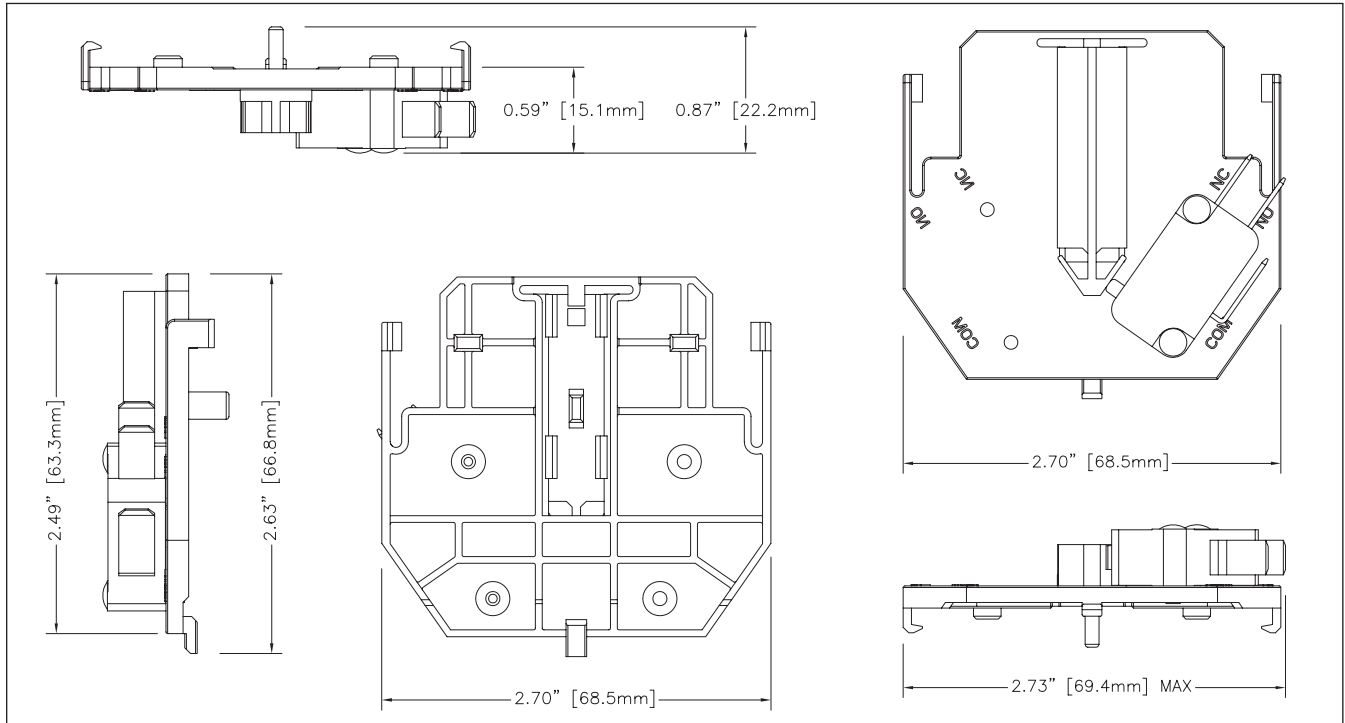

### WDPAXFD22 Accessory

