

Specialty Modules

The Do-more H2 Series PLC supports the following specialty modules.

Ethernet Communication Modules

Part Number	Description
<u>H2-ECOM100</u>	100 MBit Ethernet Communication Module

Serial Communication Modules

Part Number	Description
<u>H2-SERIO</u>	3-port RS-232 Serial I/O Module
<u>H2-SERIO-4</u>	3-port RS-232/RS-485 Serial I/O Module

Ethernet Remote I/O Modules

Part Number	Description
<u>H2-ERM100</u>	10/100Base-T Ethernet Remote Master Module
<u>H2-EBC100</u>	100 MBit Ethernet Base Controller

High Speed I/O Modules

Part Number	Description
<u>H2-CTRIO2</u>	High Speed Counter Interface Module

Input Simulator Module

Part Number	Description
<u>F2-08SIM</u>	8-point Input Simulator

Specialty Modules

H2-ECOM100 \$423.00



H2-ECOM100

Overview

Ethernet Communications Modules offer features such as:

- High-speed peer-to-peer networking of PLCs
- Fast updates with Do-more Designer Software
- High-performance access for Human Machine Interface (HMI), ERP, MES or other Windows-based software
- Industry standard Modbus TCP Client/Server Protocol

Simple connections

Use Category 5 UTP cables which can be run up to 100 meters between nodes. If needed, use repeaters to extend distances and expand the number of nodes.

Our Stride Ethernet switches are compatible with the ECOM modules. See the Communications Products section for information on these items.

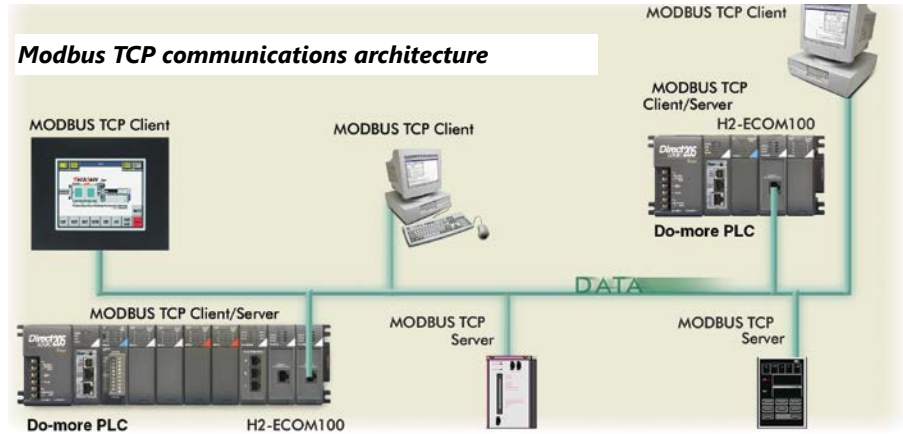

NetEdit 3 Configuration Software

NetEdit 3 Configuration Software is included in the free Do-more Designer software. Use NetEdit 3 to configure the ECOM modules for your network. Flexible addressing allows you to use your choice of protocols and identification methods. Assign each module a number, a name or both. You don't have to use an IP address, but you can if it's necessary for your network. NetEdit 3 uses two protocols for PC-to-PLC communications: IPX and TCP/IP. The NetEdit 3 screen displays all identifiers and troubleshooting information for each module on the network. You can use NetEdit 3 to adjust parameters for PLC-to-PLC communications by clicking on Advanced Settings. The network identifiers can also be changed from Do-more Designer software.

NetEdit 3 Configuration Software

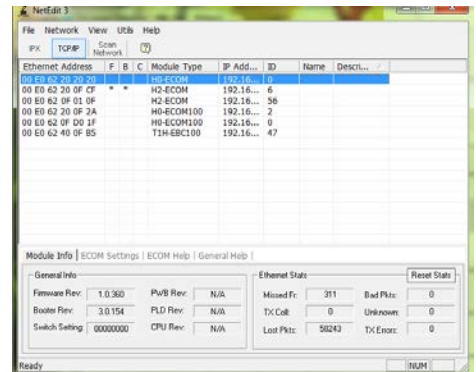

The H2-ECOM100 supports the Industry Standard Modbus TCP Client/Server Protocol

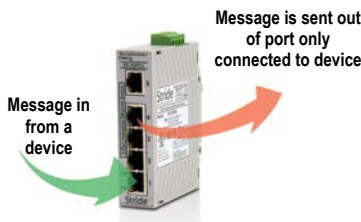

See the Communications section for details on Ethernet Switches



Specifications	H2-ECOM100
Communications	10/100Base-T Ethernet
Data Transfer Rate	100 Mbps max.
Link Distance	100 meters (328 feet)
Ethernet Port	RJ45
Ethernet Protocols	TCP/IP, IPX, Modbus TCP, DHCP, HTML (unsecure) configuration
Embedded Web Server	HTTP (unsecure)
Power Consumption	300mA @ 5VDC

Specialty Modules

H2-SERIO \$252.00
H2-SERIO-4 \$252.00



H2-SERIO / H2-SERIO-4 Specifications		
	H2-SERIO	H2-SERIO-4
Module Type	Serial Communications Module	
Approvals	cUL Listed, file number E185989	
Number of Serial Ports per Module	3 ports: all RS-232 (RJ12 jack)	3 ports: 2 RS-232 ports (RJ12 jack) and 1 RS-422/485 (5 position terminal strip)
Signals	RS-232: CTS, RXD, TXD RTS, GND RTS transmission delay times: 5, 50, 250 and 500 ms	RS-232: CTS, RXD, TXD RTS, GND RTS transmission delay times: 5, 50, 250 and 500 ms RS-422 (4 wire) : TX+, TX-, RX-, RX+, GND RS-485 (2 wire): Data+, Data-, GND
Recommended Cables	RS-232: ZL-RJ12-CBL-2	RS-232: ZL-RJ12CBL-2 RS-422: ADC L19853-x (Belden 8103) RS-485: ADC L19954-x (Belden 9842)
Protocols Supported	Do-more programming, K-sequence slave, MODBUS RTU master/slave, serial ASCII (full-duplex)	
Power Consumption	80mA @ 5VDC	
Baud Rates	1200, 2400, 4800, 9600, 19200, 38400, 57600, 115200	
Parity	None, odd, even	
Start and Stop Bits	1, 2	
Operating Environment	0 to 60°C (32°F to 140°F), 5% to 95% RH (non-condensing); No corrosive gases, Pollution level 2; Vibration: MIL STD 810C 514.2; Shock: MIL STD 810C 516.2	
Storage Temperature	-20°C to 70°C (-4°F to 158°F)	

Serial I/O Modules

Add serial ports to your Do-more H2 Series PLC system by simply plugging the H2-SERIO or H2-SERIO-4 module into the base.

The H2-SERIO module has three RS-232 ports, while the H2-SERIO-4 module has two RS-232 ports and one RS-422/485 port.

H2-SERIO(-4) Wiring: RS-232

RS-232
6 pin RJ12 Phone Type Jack – both ports

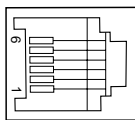

H2-SERIO(-4) RS-232 Pin Descriptions		
1	0V	Power (-) connection (GND)
2	CTS	Clear to Send
3	RXD	Receive data (RS-232)
4	TXD	Transmit data (RS-232)
5	RTS	Request to Send
6	0V	Signal Ground (GND)

H2-SERIO-4 Wiring: RS-422/485

RS422/485

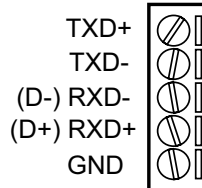

H2-SERIO-4 RS-422 Pin Descriptions		
1	TXD+	Transmit data
2	TXD-	
3	(D-) RXD-	Receive data
4	(D+) RXD+	
5	GND	Signal Ground (GND)

H2-SERIO-4 RS-485 Pin Descriptions		
1	TXD+	N/A
2	TXD-	
3	(D-) RXD-	Transmit/Receive data
4	(D+) RXD+	
5	GND	Signal Ground (GND)

Specialty Modules

H2-ERM100 \$277.00



H2-ERM100

Overview

The H2-ERM100 Ethernet Remote Master connects a Do-more H2 Series PLC's local CPU base to remote slave I/O over a high-speed Ethernet link.

Need a lot of I/O?

Each ERM module can support up to 16 additional H2-EBC100 systems, 16 Terminator I/O EBC systems (T1H-EBC100), or 16 fully expanded H4-EBC systems. Of course, combinations are fine, too. The ERM also supports Edrives. See the Drives section for details.

Note: Applications requiring an extremely large number of T1H-EBC100 analog I/O or H4-EBC 16-channel analog I/O, could exceed the buffer capacity of a single H2-ERM100 module. In these cases, an additional H2-ERM100 may be required.

Specifications	H2-ERM100
Communications	10/100BaseT Ethernet
Data Transfer Rate	100 Mbps
Link Distance	100 meters (328 feet)
Ethernet Port	RJ45
Ethernet Protocols	TCP/IP, IPX, Modbus TCP/IP, Ethernet/IP, DHCP, HTML (unsecure) configuration
Embedded Web Server	HTTP (unsecure)
Power Consumption	300mA @5 VDC

Simple connections

The H2-ERM100 connects to your control network using Category 5 UTP cables for cable runs up to 100 meters. Distances can be greatly extended with Ethernet/Fiber media converters like the SE-MC2U-ST.

The PLC, ERM and EBC slave modules work together to update the remote I/O points. These three scan cycles are occurring at the same time, but asynchronously. Critical I/O points that must be monitored every scan are best placed in the CPU base.

Networking ERMs with other Ethernet devices

It is highly recommended that a dedicated Ethernet remote I/O network be used for the H2-ERM100 and its slaves. While Ethernet networks can handle a large number of data transactions, and normally handle them very quickly, heavy Ethernet traffic can adversely affect the reliability of the slave I/O and the speed of the I/O network. Ensure ERM networks, multiple ERM networks and ECOM/office networks are isolated from one another.

Software configuration

ERM Workbench is a software utility that must be used to configure the ERM and its remote Ethernet slaves. ERM Workbench supports two methods of configuring the ERM I/O network:

- ERM Workbench PLC Wizard greatly simplifies the configuration procedure when a PLC is used as the CPU interface.
- ERM Workbench configures the I/O network whether the CPU interface is a PLC or WinPLC, and allows access to all H2-ERM100 I/O network parameters.

ERM Workbench Software

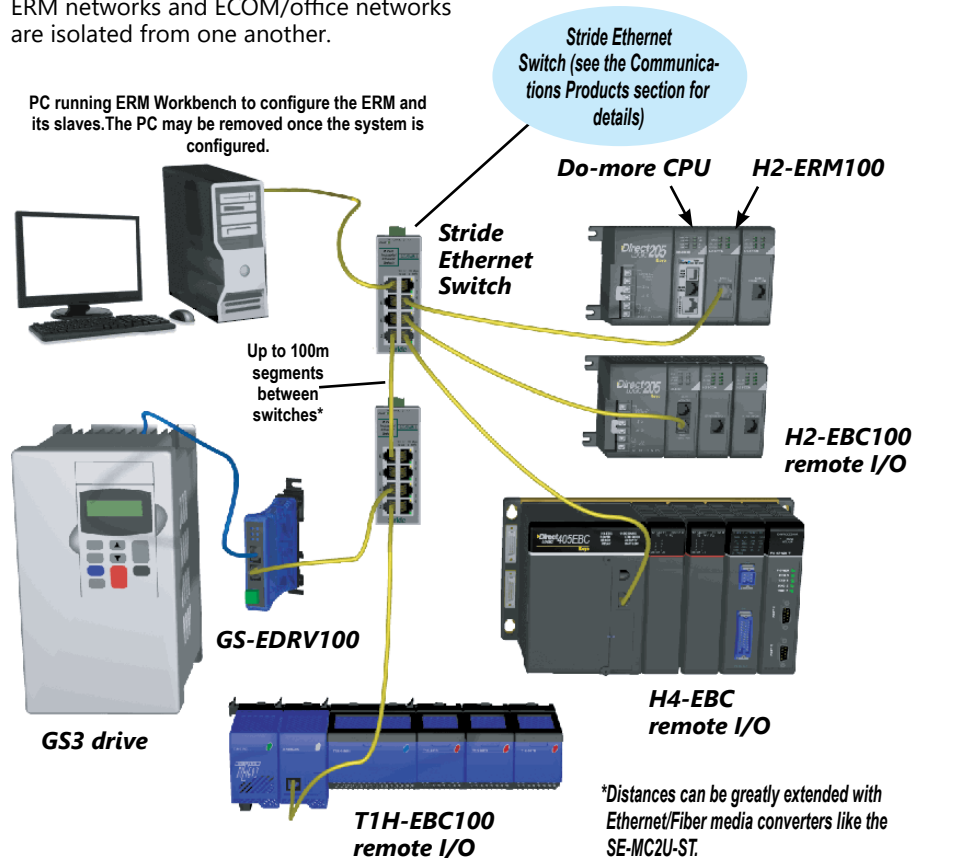
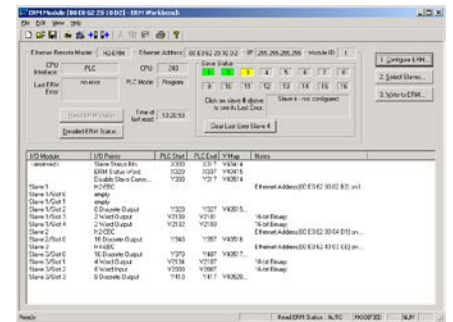

Specialty Modules

H2-EBC100 \$465.00



H2-EBC100

Use EBCs for Ethernet remote I/O slaves

The H2-EBC100 Ethernet Base Controller module provides a low-cost, high-performance Ethernet link for the Do-more H2 Series PLC using the H2-ERM100 module and Ethernet remote I/O. The H2-EBC100 supports industry standard 10/100BaseT Ethernet communications and is compatible with TCP/IP, IPX, Modbus TCP/IP and Ethernet/IP and HTTP(unsecure) protocols

Easy to use, reliable and fast

The H2-EBC100 module plugs into the CPU slot of any DL205 I/O base and supports all DL205 discrete and analog I/O modules. All EBC modules can be configured using NetEdit 3, included in the free Do-more Designer software. The H2-EBC100 also supports HTML (unsecure) configuration.

Specifications	H2-EBC100
Communications	10/100 Base-T Ethernet
Data Transfer Rate	100 Mbps max.
Link Distance	100 meters (328 feet)
Ethernet Port / Protocols	RJ45, TCP/IP, IPX, Modbus TCP/IP, Ethernet/IP DHCP, HTML(unsecure) configuration
Embedded Web Server	HTTP (unsecure)
Serial Port / Protocols	RJ12, K-Sequence, ASCII IN/OUT Modbus RTU
Power Consumption	300mA

Do-more H2 Series PLC

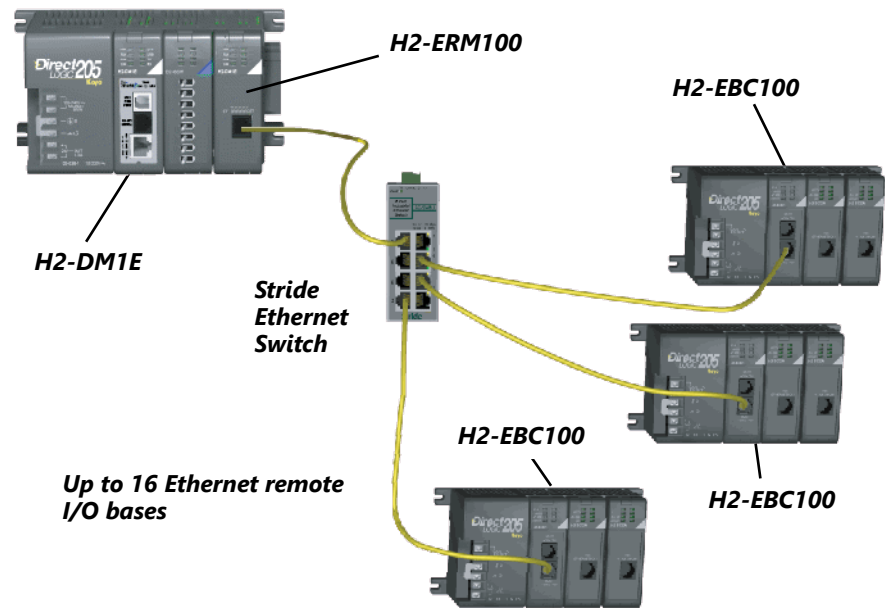

Up to 16 Ethernet remote I/O bases

NetEdit 3 Configuration Software

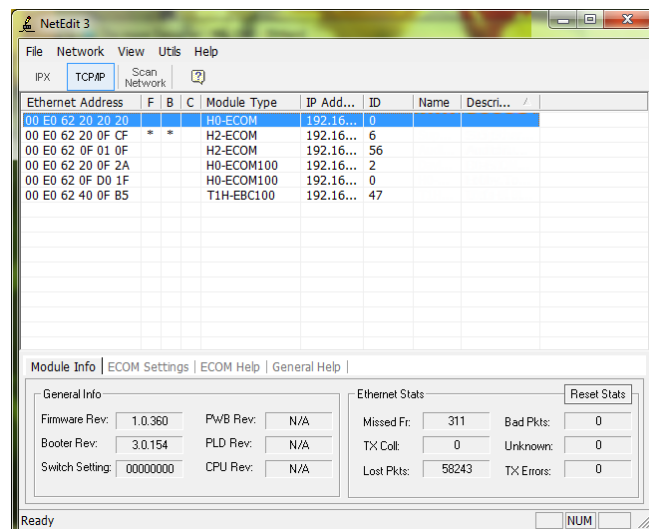

Specialty Modules

H2-CTRIO2 \$445.00



H2-CTRIO2

Overview

The H2-CTRIO2 Counter I/O module is designed to accept high-speed pulse input signals for counting or timing applications. This module also provides a high-speed pulse output signal for servo/stepper motor control, monitoring and alarming as well as other discrete control functions.

The CTRIO2 module offers greater flexibility for applications which call for precise counting or timing based on input events or for high speed control output applications. It can also be used for applications that call for a combination of both high-speed input and high-speed output control functions.

The CTRIO2 module has its own microprocessor and operates asynchronously with respect to the CPU. Therefore, the response time of the on-board outputs is based on the module scan time, not the CPU scan time.

Software Configuration

All scaling and configuration is done from within the Edit CTRIO/CTRIO2 Configuration window of Do-more Designer. This eliminates the need for PLC ladder programming or other interface device programming to configure the module.

General Specifications	
Specifications	H2-CTRIO2
Discrete I/O Points Used	None (I/O map directly in H2-DM1/E data structure)
Base Power Required	275mA Max
Isolation	1500V I/O to Logic, 1000V among Input Channels and All Outputs

Input Specifications	
Specifications	H2-CTRIO2
Inputs	8 pts sink/source
Maximum Input Frequency	250kHz
Minimum Pulse Width	0.5 µsec
Input Voltage Range	9–30 VDC
Maximum Voltage	30VDC
Input Voltage Protection	Zener Clamped at 33VDC
Rated Input Current	8mA typical 12mA maximum
Minimum ON Voltage	9.0 VDC
Maximum OFF Voltage	2.0 VDC
Minimum ON Current	5.0 mA
Maximum OFF Current	2.0 mA
OFF to ON Response	< 0.5 µsec
ON to OFF Response	< 0.5 µsec

Output Specifications	
Specifications	H2-CTRIO2
Outputs	4 pts (sink/source), independently isolated
Pulse Outputs	2 channels, 20Hz to 250kHz Pulse/Direction or CW/CCW
Minimum Pulse Width	0.5 µsec
Output Voltage Range	5–36 VDC
Maximum Output Voltage	36VDC
Maximum Load Current	1.0 A at 23°C 0.5 A at 60°C
Maximum Leakage Current	100µA
Inrush Current	2.0 A for 10ms
ON State V Drop	0.45 VDC or less
Overcurrent Protection	Yes
OFF to ON Response	<1 µsec
ON to OFF Response	<1 µsec
Maximum Output Frequency	
Velocity Mode	65kHz
Run to Limit Mode	
Run to Position Mode	
Trapezoid	
S-Curve	
Symmetrical S-Curve	250kHz
Dynamic Positioning	
Home Search	
Free Form	
Dynamic Velocity	
Dynamic Positioning Plus	250kHz
Trapezoid Plus	
Trapezoid with Limits	

Edit CTRIO2 Configuration Window

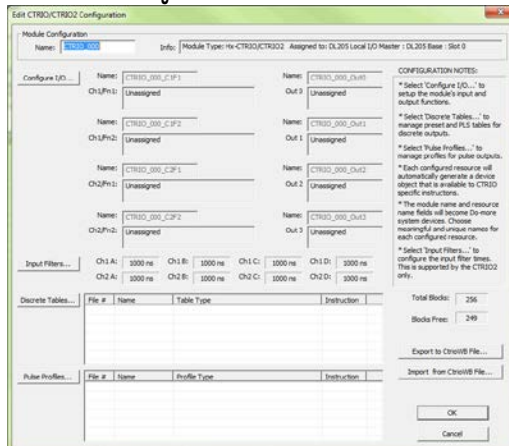

Inputs Supported:

- Counter
- Quad Counter
- Pulse Catch
- Edge Timer
- Dual Edge Timer

Outputs Supported:

- Pulse train - used for servo/stepper motor control. Configurable for CW/CCW or step and direction
- Discrete outputs - assigned to Counter/Timer input functions
- Raw output - outputs controlled directly from the CPU interface program
- Programmable limit switch

Specialty Modules

F2-08SIM \$107.00



F2-08SIM

F2-08SIM Input Simulator	
Inputs per Module	8
Base Power Required 5VDC	50mA
Terminal Type	None
Status Indicator	Switch side
Weight	2.65 oz. (75g)

Do-more H2 Series PLC Overview

Module Compatibility

The following table shows which DL205 components are supported by the H2-DM1 and H2-DM1E Do-more CPUs.

Module Compatibility Table						
Module	Part Number	Status	Module	Part Number	Status	
Base Units	D2-03B-1	✓	Analog I/O Modules	D2-03B-1	✓	
	D2-04B-1	✓		D2-04B-1	✓	
	D2-06B-1	✓		D2-06B-1	✓	
	D2-09B-1	✓		D2-09B-1	✓	
	D2-03BDC1-1	✓		D2-03BDC1-1	✓	
	D2-04BDC1-1	✓		D2-04BDC1-1	✓	
	D2-06BDC1-1	✓		D2-09BDC1-1	✓	
	D2-09BDC1-1	✓		D2-06BDC2-1	✓	
	D2-06BDC2-1	✓		D2-09BDC2-1	✓	
	D2-09BDC2-1	✓		D2-09BDC2-1	✓	
Discrete I/O Modules	D2-08ND3	✓	Local Expansion Modules	D2-08ND3	✓	
	D2-16ND3-2	✓		D2-16ND3-2	✓	
	D2-32ND3	✓		D2-32ND3	✓	
	D2-32ND3-2	✓		D2-32ND3-2	✓	
	D2-08NA-1	✓		D2-08NA-1	✓	
	D2-08NA-2	✓		D2-08NA-2	No	
	D2-16NA	✓		D2-16NA	No	
	D2-04TD1	✓		Specialty Modules	D2-04TD1	✓
	D2-08TD1	✓			D2-08TD2	No
	D2-08TD2	✓			D2-16TD1-2	
	D2-16TD1-2	✓	D2-16TD2-2		✓	
	D2-16TD2-2	✓	F2-16TD1P		No	
	F2-16TD1P	✓	F2-16TD2P		No	
	F2-16TD2P	✓	D2-32TD1		✓	
	D2-32TD1	✓	D2-32TD2		✓	
	D2-32TD2	✓	D2-08TA		✓	
	D2-08TA	✓	F2-08TA		✓	
	F2-08TA	✓	D2-12TA	No		
	D2-12TA	✓	D2-04TRS	✓		
	D2-04TRS	✓	D2-08TR	No		
	D2-08TR	✓	F2-08TR	✓		
	F2-08TR	✓	F2-08TRS	✓		
	F2-08TRS	✓	D2-12TR	No		
	D2-12TR	✓	Programmer	D2-12TR	No	
	D2-08CDR	✓		D2-08CDR		

✓ = Supported No = Not Supported

Do-more H2 Series PLC Overview

Communications

The Do-more H2 Series PLC supports many communication protocols. The following table shows which CPU module communications port or specialty module supports each protocol.

Protocols	CPU Modules			Specialty Modules		
	<i>H2-DM1 / H2-DM1E</i>		<i>H2-DM1E</i>	<i>H2-ECOM100</i>	<i>H2-SERIO H2-SERIO-4</i>	<i>H2-ERM100</i>
	USB Port	RS-232 Serial Port	Ethernet Port			
<i>Do-more Designer Programming</i>	Yes	Yes	Yes	Yes	Yes	
<i>Modbus/RTU Client (Master)</i>		Yes			Yes	
<i>Modbus/RTU Server (Slave)</i>		Yes			Yes	
<i>Modbus/TCP Client (Master)</i>			Yes	Yes		
<i>Modbus/TCP Server (Slave)</i>			Yes	Yes		
<i>DirectLOGIC RX/WX Client (Master)</i>			Yes	Yes		
<i>DirectLOGIC RX/WX Server (Slave)</i>			Yes	Yes		
<i>K-Sequence Server (Slave)</i>		Yes		Yes	Yes	
<i>DirectNET Server (Slave)</i>				Yes		
<i>Embedded Web Server: HTTP (unsecure)</i>				Yes		Yes
<i>Ethernet: HTML (unsecure) configuration</i>				Yes		Yes
<i>HEI Ethernet Remote I/O Master</i>			Yes			Yes
<i>SMTP (EMail) Client w/Authentication</i>			Yes			
<i>Simple Network Time Protocol (SNTP) Client</i>			Yes			
<i>Do-more/PEERLINK</i>			Yes			
<i>Do-more Time Synchronization Protocol (Client, Server, Alternate Client)</i>			Yes			
<i>Do-more Logger/UDP</i>			Yes			
<i>Serial ad-hoc ASCII/Binary Programmatic Control</i>		Yes			Yes	
<i>UDP ad-hoc Programmatic Control</i>			Yes			
<i>TCP Client Programmatic Control</i>			Yes			
<i>TCP Server Programmatic Control</i>			Yes			

Blank = Not Supported



Wiring Solutions

Wiring Solutions using the ZIPLink Wiring System

ZIPLinks simplify the normally tedious process of wiring between devices by utilizing prewired cables and DIN rail mount connector modules. It's as simple as plugging in a cable connector at either end or terminating wires at only one end. Prewired cables keep installation clean and efficient, using half the space at a fraction of the cost of standard terminal blocks. There are several wiring solutions available when using the **ZIPLink** System ranging from PLC I/O-to-**ZIPLink** Connector Modules that are ready for field termination, options for connecting to third party devices, GS,

Solution 1: Do-more H2 Series PLC to ZIPLink Connector Modules

When looking for quick and easy I/O-to-field termination, a **ZIPLink** connector module used in conjunction with a prewired **ZIPLink** cable, consisting of an I/O terminal block at one end and a multi-pin connector at the other end, is the best solution.



DuraPulse and SureServo Drives, and specialty relay, transorb and communications modules. Pre-printed I/O-specific adhesive label strips for quick marking of **ZIPLink** modules are provided with **ZIPLink** cables. See the following solutions to help determine the best **ZIPLink** system for your application.

Using the PLC I/O Modules to **ZIPLink** Connector Modules selector tables located in this section,

1. Locate your I/O module/PLC.
2. Select a **ZIPLink** Module.
3. Select a corresponding **ZIPLink** Cable.

Solution 2: Do-more H2 Series PLC to 3rd Party Devices

When wanting to connect I/O to another device within close proximity of the I/O modules, no extra terminal blocks are necessary when using the **ZIPLink** Pigtail Cables. **ZIPLink** Pigtail Cables are prewired to an I/O terminal block with color-coded pigtail with soldered-tip wires on the other end.



Using the I/O Modules to 3rd Party Devices selector tables located in this section,

1. Locate your PLC I/O module.
2. Select a **ZIPLink** Pigtail Cable that is compatible with your 3rd party device.

Solution 3: GS Series and DuraPulse Drives Communication Cables

Need to communicate via Modbus RTU to a drive or a network of drives?

ZIPLink cables are available in a wide range of configurations for connecting to PLCs and SureServo, SureStep, Stellar Soft Starter and AC drives. Add a **ZIPLink** communications module to quickly and easily set up a multi-device network.

Using the Drives Communication selector tables located in this section,

1. Locate your Drive and type of communications.
2. Select a **ZIPLink** cable and other associated hardware.





Wiring Solutions

Solution 4: Serial Communications Cables

ZIPLink offers communications cables for use with Do-more H2 Series CPUs, that can also be used with other communications devices. Connections include a 6-pin RJ12 or 9-pin, 15-pin and 25-pin D-sub connectors which can be used in conjunction with the RJ12 or D-Sub Feedthrough modules.

Using the Serial Communications Cables selector table located in this section,

1. Locate your connector type
2. Select a cable.



Solution 5: Specialty ZIPLink Modules

For additional application solutions, **ZIPLink** modules are available in a variety of configurations including stand-alone relays, 24VDC and 120VAC transorb modules, D-sub and RJ12 feedthrough modules, communication port adapter and distribution modules, and SureServo 50-pin I/O interface connection.

Using the **ZIPLink** Specialty Modules selector table located in this section,

1. Locate the type of application.
2. Select a **ZIPLink** module.



Solution 6: ZIPLink Connector Modules to 3rd Party Devices

If you need a way to connect your device to terminal blocks without all that wiring time, then our pigtail cables with color-coded soldered-tip wires are a good solution. Used in conjunction with any compatible **ZIPLink** Connector Modules, a pigtail cable keeps wiring clean and easy and reduces troubleshooting time.

Using the Universal Connector Modules and Pigtail Cables table located in this section,

1. Select module type.
2. Select the number of pins.
3. Select cable.





Wiring Solutions

Do-more/DL205 PLC Input Module ZIPLink Selector				
PLC		ZIPLink		
Input Module	# of Terms	Component	Module	Cable †
D2-08ND3	10	Feedthrough	ZL-RTB20	ZL-D2-CBL10 *
D2-16ND3-2	19	Feedthrough	ZL-RTB20	ZL-D2-CBL19 *
		Sensor	ZL-LTB16-24	ZL-D2-CBL19 *
D2-32ND3¹	40	Feedthrough	ZL-RTB40	ZL-D24-CBL40 *
				ZL-D24-CBL40 *X
		Sensor	ZL-LTB32-24	ZL-D24-CBL40 *
				ZL-D24-CBL40 *X
D2-32ND3-2¹	40	Feedthrough	ZL-RTB40	ZL-D24-CBL40 *
				ZL-D24-CBL40 *X
		Sensor	ZL-LTB32-24	ZL-D24-CBL40 *
				ZL-D24-CBL40 *X
D2-08NA-1	10	Feedthrough	ZL-RTB20	ZL-D2-CBL10 *
D2-08NA-2	10	Feedthrough	ZL-RTB20	ZL-D2-CBL10 *
D2-16NA	19	Feedthrough	ZL-RTB20	ZL-D2-CBL19 *

† X in the part number represents a 45° angle plug.

Do-more/DL205 PLC Combo In/Out Module ZIPLink Selector				
PLC		ZIPLink		
Combo Module	# of Terms	Component	Module	Cable
D2-08CDR	10	Feedthrough	ZL-RTB20	ZL-D2-CBL10 *
H2-CTRIO2	19	Feedthrough	ZL-RTB20 (-1)	ZL-D2-CBL19 *

Do-more/DL205 PLC Analog Module ZIPLink Selector						
PLC		ZIPLink				
Analog Module	# of Terms	Component	Module	Cable		
F2-04AD-1	10	Feedthrough	ZL-RTB20	ZL-D2-CBL10 *		
F2-08AD-1						
F2-04AD-2						
F2-08AD-2						
F2-02DA-1						
F2-02DAS-1	19			ZL-RTB20	ZL-D2-CBL19 *	
F2-08DA-1						
F2-02DA-2						
F2-02DAS-2						
F2-08DA-2						
F2-4AD2DA	10	ZL-RTB20	ZL-D2-CBL10 *			
F2-8AD4DA-1						
F2-8AD4DA-2						
F2-04RTD⁴	Matched Only			See Note 4	ZL-RTB20	ZL-D2-CBL19 *
F2-04THM⁴	Matched Only					

Do-more/DL205 PLC Output Module ZIPLink Selector				
PLC		ZIPLink		
Output Module	# of Terms	Component	Module	Cable †
D2-04TD1¹	10	Feedthrough	ZL-RTB20	ZL-D2-CBL10 *
D2-08TD1	10	Feedthrough		ZL-D2-CBL10 *
D2-08TD2	10	Feedthrough		ZL-D2-CBL10 *
D2-16TD1-2	19	Feedthrough		ZL-D2-CBL19 *
		Fuse	ZL-RFU20⁵	ZL-D2-CBL19 *
D2-16TD2-2	19	Feedthrough	ZL-RTB20	ZL-D2-CBL19 *
		Fuse	ZL-RFU20⁵	ZL-D2-CBL19 *
		Relay	ZL-RRL16-24-2	ZL-D2-CBL19 *
F2-16TD1P	19	Feedthrough	ZL-RTB20	ZL-D2-CBL19 *
F2-16TD2P	19	Feedthrough	ZL-RTB20	ZL-D2-CBL19 *
D2-32TD1¹	40	Feedthrough	ZL-RTB40	ZL-D24-CBL40 *
		Fuse	ZL-RFU40⁵	ZL-D24-CBL40 *
D2-32TD2¹	40	Feedthrough	ZL-RTB40	ZL-D24-CBL40 *
		Fuse	ZL-RFU40⁵	ZL-D24-CBL40 *
D2-08TA	10	Feedthrough	ZL-RTB20	ZL-D2-CBL10 *
F2-08TA	10	Feedthrough		ZL-D2-CBL10 *
D2-12TA	19	Feedthrough	ZL-RFU20⁵	ZL-D2-CBL19 *
		Fuse		ZL-D2-CBL19 *
D2-04TRS²	10	Feedthrough	ZL-RTB20	ZL-D2-CBL10 *
D2-08TR	10	Feedthrough		ZL-D2-CBL10 *
F2-08TRS²	19	Feedthrough		ZL-D2-CBL19 *
F2-08TR3	10	Feedthrough		ZL-D2-CBL10 *
D2-12TR	19	Feedthrough	ZL-RFU20⁵	ZL-D2-CBL19 *
		Fuse		ZL-D2-CBL19 *

† X in the part number represents a 45° angle plug.

* Select the cable length by replacing the * with: blank = 0.5 m, -1 = 1.0 m, or -2 = 2.0 m.

1 To make a custom cable for the 32-point modules, use: Solder-style 180° connector [ZL-D24-CON](#) or Solder-style 45° connector [ZL-D24-CON-X](#).

2 Caution: The [D2-04TD1](#), [D2-04TRS](#), and [F2-08TRS](#) outputs are derated not to exceed module specs 2A per point and 2A per common when used with the ZIPLink wiring system.

3 The [F2-08TR](#) outputs are derated not to exceed 2A per point and 4A per common when used with the ZIPLink wiring system.

4 The [F2-04RTD](#) and [F2-04THM](#) modules are not supported by the ZIPLink wiring system.

5 Note: Fuses (5 x 20 mm) are not included. See Edison Electronic Fuse section for (5 x 20 mm) fuse. S500 and GMA electronic circuit protection for fast-acting maximum protection. S506 and GMC electronic circuit protection for time-delay performance. Ideal for inductive circuits. To ensure proper operation, do not exceed the voltage and current rating of ZIPLink module. [ZL-RFU20](#) = 2A per circuit; [ZL-RFU40](#) = 400mA per circuit.



Note: ZIPLink Connector Modules and ZIPLink Cables specifications are in the ZIPLink catalog section.

Base Units

Power Budget

When determining the types and quantity of I/O modules you will be using, it is important to remember there is a defined amount of power available from the base power supply.

The chart on the next page indicates the power supplied and used by each module. The adjacent chart shows an example of how to calculate the power used by your particular system. These charts should make it easy for you to determine if the devices you have chosen will operate within the power budget of your system configuration.

If the I/O you have chosen for a base exceeds the maximum power available from the power supply, you may be able to resolve the problem by using remote I/O bases.

Base power supply specifications

The table below lists base power supply specifications, including maximum inrush current and maximum power consumed from your power source.

Power budget example

The example on the right shows how to calculate the power budget for the Do-more PLC system. The examples are constructed around a single 9-slot base using the devices shown. It is recommended you construct a similar table for your Do-more PLC system. Follow the steps to the right to determine your power budget.

- Using a chart similar to the one below, fill in column 2.
- Using the tables on the next page, enter the current supplied and used by each device (columns 3 and 4). Devices which fall into the "Other" category (Row D) are devices such as the operator interface and the handheld programmer, which also have power requirements, but do not directly plug into the base.
- Add the current used by the system devices (columns 3 and 4) starting with the CPU slot and put the total in the row labeled "Maximum Current Required" (Row E).
- Subtract the row labeled "Maximum Current Required" (Row E), from the row labeled "Current Supplied" (Row B). Place the difference in the row labeled "Remaining Current Available" (Row F).
- If "Maximum Current Required" is greater than "Current Supplied" in either column 3 or 4, the power budget will be exceeded. It will be unsafe to use this configuration, and you will need to restructure your I/O configuration. Note the auxiliary power supply does not need to supply all the external power. If you need more than the 300mA supplied, you can add an external 24V power supply. This will help keep you within your power budget for external power.

A	Column 1	Column 2	Column 3	Column 4
		<i>Device Type</i>	<i>5VDC (mA)</i>	<i>External Power 24 VDC (mA)</i>
B	CURRENT SUPPLIED			
	Base	9 slot	2,600	300
C	CURRENT REQUIRED			
	CPU SLOT			
	SLOT 0	H2-DM1E	275	0
	SLOT 1	D2-16ND3-2	100	0
	SLOT 2	D2-16ND3-2	100	0
	SLOT 3	D2-16NA	100	0
	SLOT 4	D2-08NA-1	50	0
	SLOT 5	D2-16TD1-2	200	80
	SLOT 6	D2-08TA	250	0
	SLOT 7	D2-08TA	250	0
D	OTHER			
	Operator interface	EA1-S3ML	220	0
E	Maximum Current Required		1545	80
F	Remaining Current Available		2600-1545=1055	300-80=220

Power Supply Specifications			
Specification	AC Powered Bases	24VDC Powered Bases	125VDC Powered Bases
Part Numbers	D2-03B-1, D2-04B-1, D2-06B-1, D2-09B-1	D2-03BDC1-1, D2-04BDC1-1 D2-06BDC1-1, D2-09BDC1-1	D2-06BDC2-1, D2-09BDC2-1
Voltage Withstand (dielectric)	1 minute @ 1500VAC between primary, secondary, field ground, and run relay		
Insulation Resistance	> 10MΩ at 500VDC		
Input Voltage Range	85-132 VAC (110 range) 170-264 VAC (220 range) 47-63 Hz	10.2-28.8 VDC (24VDC) with less than 10% ripple	100-264 VDC (125 VDC) with less than 10% ripple
Auxiliary 24VDC Output	300mA max.	None	300mA max.
Maximum Inrush Current	30A	10A	20A
Maximum Power	80VA	25W	30W

Base Units

Power Requirements

This section shows the amount of power supplied by each of the base power supplies and the amount of power consumed by each module. The Power Consumed charts list how much INTERNAL power from each power source is required for the modules. Use this information when calculating the power budget for your system.

In addition to the internal power sources, bases offer a 24VDC auxiliary power supply with external power connections. This auxiliary power supply can power external devices.

Use ZipLinks to reduce power requirements

If your application requires a lot of relay outputs, consider using the ZipLink AC or DC relay output modules ZL-RRL16-24-1 or ZL-RRL16-24-2. These modules can switch high current (10A) loads without putting a heavy load on your base power budget. Refer to the Terminal Blocks and Wiring Solutions section in this catalog for more information.

This logo is placed next to the I/O modules that are supported by the **ZIP**Link connection systems. See the I/O module specifications at the end of this section.



Power Supplied					
Device	5V(mA)	24V Auxiliary	Device	5V(mA)	24V Auxiliary
Bases			Bases		
D2-03B-1	2600	300	D2-04BDC1-1	2600	None
D2-04B-1	2600	300	D2-06BDC1-1	2600	None
D2-06B-1	2600	300	D2-09BDC1-1	2600	None
D2-09B-1	2600	300	D2-06BDC2-1	2600	300
D2-03BDC1-1	2600	None	D2-09BDC2-1	2600	300

Power Consumed		
Device	5V(mA)	24V Auxiliary
CPUs		
H2-DM1	250	0
H2-DM1E	275	0
DC Input Modules		
D2-08ND3	50	0
D2-16ND3-2	100	0
D2-32ND3	25	0
D2-32ND3-2	25	0
AC Input Modules		
D2-08NA-1	50	0
D2-08NA-2	100	0
D2-16NA	100	0
DC Output Modules		
D2-04TD1	60	20
D2-08TD1	100	0
D2-08TD2	100	0
D2-16TD1-2	200	80
D2-16TD2-2	200	0
F2-16TD1P	70	50
F2-16TD2P	70	50
D2-32TD1	350	0
D2-32TD2	350	0
AC Output Modules		
D2-08TA	250	0
F2-08TA	250	0
D2-12TA	350	0
Relay Output Modules		
D2-04TRS	250	0
D2-08TR	250	0
F2-08TR	670	0
F2-08TRS	670	0
D2-12TR	450	0
Combination In/Out Module		
D2-08CDR	200	0

Power Consumed		
Device	5V(mA)	24V Auxiliary
Analog Modules		
F2-04AD-1	100	5
F2-04AD-2	110	5
F2-08AD-1	100	5
F2-08AD-2	100	5
F2-02DA-1	40	60 (note 1)
F2-02DA-2	40	60
F2-02DA-2L	40	70 @ 12V
F2-02DAS-1	100	50 / channel
F2-02DAS-2	100	60 / channel
F2-08DA-1	30	50 (note 1)
F2-08DA-2	60	140
F2-4AD2DA	60	80 (note 1)
F2-8AD4DA-1	35	100 (note 1)
F2-8AD4DA-2	35	80 (note 1)
F2-04RTD	90	0
F2-04THM	110	60
Specialty Modules		
H2-CTRIO2	275	0
H2-EBC100	300	0
H2-ECOM100	300	0
H2-ERM100	300	0
H2-SERIO	80	0
H2-SERIO-4	80	0
F2-08SIM	50	0

Note 1: Add an additional 20mA per output loop.