

# DL305 Family of Products

## DL305 system example with serial communications network and operator interface

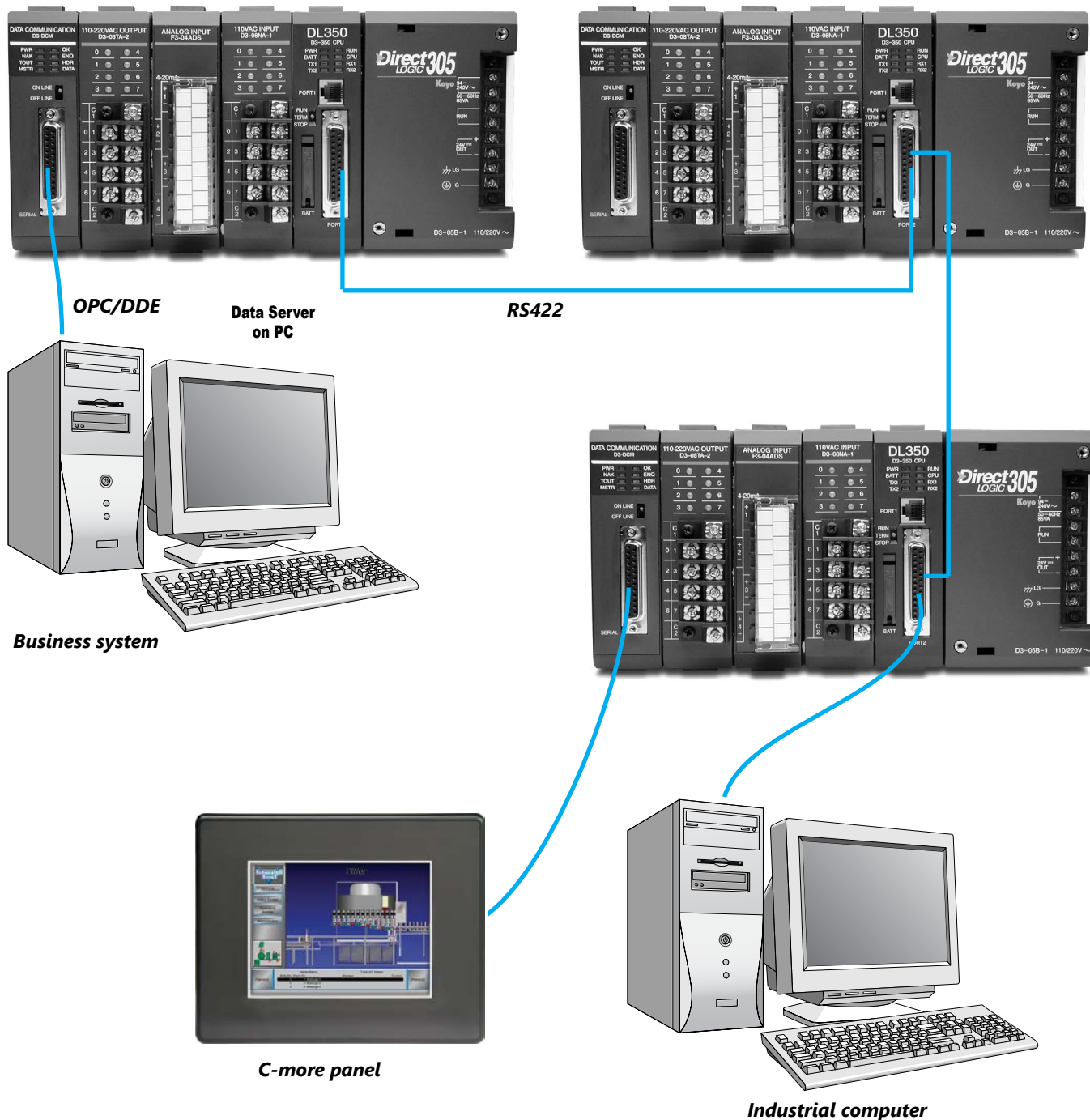

# DL305 Family of Products

The following is a quick summary of the DL305 family of products. The DL305 products have been sold by previous vendors under a wide variety of part numbers. A complete list of product offerings with vendor cross-reference is available in the DL305 price list.

## CPUs

**D3-350 is discontinued. Please consider the Productivity, BRX, or CLICK Systems.**

## Specialty CPUs

### F3-OMUX-2

- Serial interface to Optomux host
- 2 communication ports (RS422/485)

## Bases

**All DL305 bases have been retired. Please consider the Productivity, BRX, or CLICK Systems.**

## Analog modules

- 4 Channel IN, 12-bit, isolated

## Discrete input modules

### DC Input

- 16-pt. 5V/12-24 VDC (sink/source, 1ms response)

### AC/DC Input

- 8-pt. 24VAC/DC

## Discrete output modules

### RELAY Output

- 8-pt. 10.0A/pt isolated

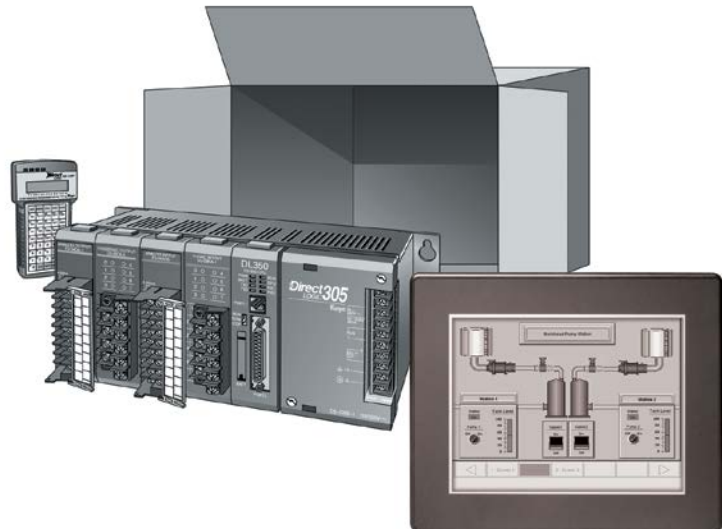

## Programming

Handheld programmer: [D2-HPP](#) \$590.00  
D2-HPP Handheld Programmer with built-in RLLPLUS for [D3-350](#)

*DirectSOFT Programming for Windows (PC-DSOFT6)*

[PC-DSOFT6](#) \$462.00

[PC-DS100](#) Free

[PC-R60-U](#) (upgrade) \$291.00

## DIN rail mounted terminal blocks

See the Connection Systems section for over 200 available options.

## Communications

- Data Comm Module, 350 CPU only

## Operator panels

See the Operator Interface section for a complete listing of all types of panels and software.

## Connection systems

See the Wiring Solutions section in this catalog for information on *DINnector* terminal blocks, *ZPLink* connection systems and other connection accessories for use with the DL305 system.

**D3-350 and F3-PMUX-1 CPUs, D3-05BDC and D3-10BDC bases have been retired. Please consider integrating to our Productivity, BRX, or CLICK PLC systems.**

# DL305 Specialty CPUs

Your application may require an unconventional PLC solution. For instance, you may need computer-controlled I/O (the PLC I/O is controlled directly by your personal computer), or maybe you would like a PLC that executes a control program written entirely in BASIC instead of RLL. AutomationDirect offers three specialty CPUs that provide solutions for each of these applications.

## Computer I/O CPUs

A CPU is available for the DL305 family that allows DL305 I/O (with DL305 bases) to function as computer-controlled I/O. The CPU (F3-OMUX-2) are similar in functionality, but offer different communication options. The CPU allows DL305 modules of most types (see restrictions on types) to interface with a host computer. The entire control program for the DL305 I/O is executed on the host computer, which uses an OPTOMUX or PAMUX driver.

The following table shows the various features found on the DL305 specialty CPU.

F3-OMUX-n	
<b>Communication port specifications</b>	
<b>Interface</b>	F3-OMUX-2: RS422/485 (isolated)
<b>Connector</b>	Two 9-pin D-sub sockets (female)
<b>Baud Rate</b>	Port 1: 300, 1200, 2400, 4800, 9600, 9200, 38400, 57600, 115200 Port 2: 9600
<b>Protocol</b>	OPTO 22 serial communications

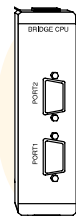

## I/O module restrictions

The specialty CPU can make use of almost all DL305 modules, but does not support the D3-HSC, or D3-02DA modules.

## F3-OMUX-2 \$1,019.00

The F3-OMUX-2) CPU plugs into the first slot of a DL305 base. It acts as a serial interface to the control program in the host computer and up to 184 DL305 I/O per CPU. Multiple CPUs can be daisy-chained together to increase I/O count. The host computer must use an OPTOMUX serial communication driver. The host can execute a custom program or use a standard software package that supports OPTOMUX drivers such as Intouch-Wonderware, Iconics-Genesis, U.S. Data FactoryLink, Metra-Skyhawk Lt, etc.

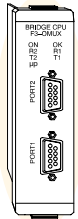

## General Specifications

- Two serial ports that support the OPTOMUX protocol
- RS422/RS485 (isolated)
- Max of 184 I/O points per CPU (with expansion base unit)
- Scan time is dependent on the communication speed, number of commands sent, type of commands sent, the size of the response and the speed of the host computer.

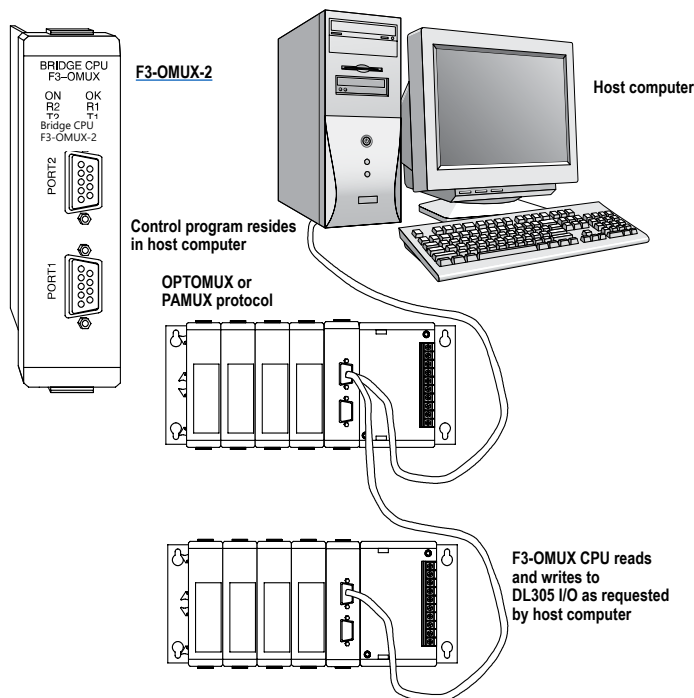

# Communications

## Determine your communications requirements

The choice of CPU can have a big impact on your communications capabilities in the DL305 family. If you are considering doing any communications, you should use the [D3-350 CPU](#).

## Standard communications

The [D3-350 CPU](#) offers two built-in RS232C communication ports. Operator interfaces and DirectSOFT can be connected to either port. On the [D3-350 CPU](#), the handheld programmer is attached to Port 1. The handheld programmer can be operated simultaneously with the communication ports. Port 1 on the [D3-350](#) is fixed. Port 2 can be configured using the handheld programmer or DirectSOFT.

## DL305 as a server on a network

Both ports on the [D3-350 CPU](#) can serve as server ports for DirectNET. The bottom ports offer additional flexibility in that they can serve as a Server on a Modbus RTU network. The [D3-350](#) even supports RS422, so no RS232-to-RS422 converter is needed. No programming is required in these CPUs for them to act as Server ports.

## DL305 as a network client

The bottom built-in communication port of the [D3-350 CPU](#) can serve as a Network Client for DirectNET. Up to 90 Server stations can be addressed. The [D3-350](#) can also serve as a MODBUS RTU Client; up to 247 Server stations can be addressed. DL405, DL305 and DL205 controllers can be used as Server stations.

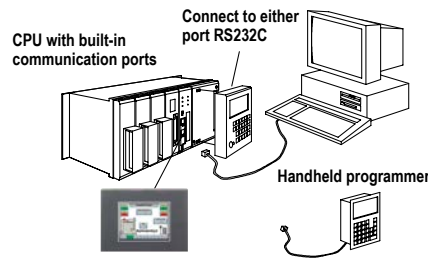

Network Addresses		
Port	Protocol	Range
1	Server	1-90
2	Server	1-90
	Client	0
	MODBUS/RTU	1-247

## Custom drivers

The DL305 product family supports the DirectNET protocol. However, in some applications you may have a need to connect to a device that does not support this protocol. If so, the ASCII/BASIC modules also allow you to write your own custom communication drivers (in BASIC) to connect to special devices. These high-speed modules offer communication rates up to 115.2K baud on RS232C, RS422, and RS485. With 128K of memory, there is ample program or data storage space. (These modules are not supported by the [D3-350](#).)

# I/O Selection

## Choose your I/O modules

There are three major factors to consider when choosing an I/O module:

### **Environmental specifications:**

What environmental conditions will be present?

### **Hardware specifications:**

Does this product have the right features, performance and capacity to adequately serve the application?

### **Field termination:**

How does this module connect to field devices? For DC modules, is a sinking or sourcing module required?

## Review I/O hardware specifications

The hardware specifications for every DL305 module are listed with each module. Discrete module specifications are shown in a format similar to the example to the right. Take time to understand the specification chart, the derating curve and the wiring diagram.

Specialty module specifications are shown in a format that is relevant for each particular module. These module specifications should help you determine if this module is right for your application.

## Environmental specifications

The adjacent table lists the environmental specifications that globally apply to the DL305 system (CPU, Bases, and I/O modules). Be sure the modules you choose are operated within these environmental specifications.

General I/O Module Specifications	
Specification	Rating
<b>Storage Temperature</b>	4°F – 158°F (-20°C to 70°C)
<b>Ambient operating temperature</b>	32°F – 140°F (0° to 60°C)
<b>Ambient humidity</b>	5% - 95% relative humidity (non-condensing)
<b>Vibration resistance</b>	MIL STD 810C, Method 514.2
	Shifting: 0.075 mm 10–57 Hz 3 axes
	Acceleration: 9.8 m/s <sup>2</sup> 57–150 Hz 3 axes
	Sweeping: 810C, Method 516.2
<b>Peak accel</b>	147 m/s <sup>2</sup> 11ms, 3 axes
<b>Noise immunity</b>	NEMA (ICS3-304)
<b>Atmosphere</b>	No corrosive gases

# I/O Selection

## Factors affecting field termination

Sinking and sourcing for DC field devices: If you are using a DC type of field device, then you should consider whether the device is a sinking or sourcing configuration. This may affect your module selection since it determines the manner in which the device must be wired to the module. (Both sinking and sourcing modules are available.) Refer to the sinking/sourcing section of the Appendix for a complete explanation of how this could affect your system.

Physical wire terminations: In general, DL305 modules use five types of field terminations. They include: removable terminal blocks (included on most 8 and 16-point modules), fixed terminal blocks; specialty D-sub connectors (used on a few 16-point modules), standard D-sub connectors (used on most specialty intelligent modules), and phone jack style (used on some specialty modules and the universal cable kit). The module descriptions indicate the connector type that is on the module. The following illustrations shows these types of connectors. You can also use our DIN rail-mounted terminal blocks, DINnectors, or **ZIPLink** cables as a field termination interface to the PLC and I/O modules.

## Choose your modules

Now that you understand the factors that affect your choice of an I/O module, it's time to choose ones that best suit your needs. When you have selected the modules, proceed to the next section to choose an I/O configuration scheme that best suits your application.

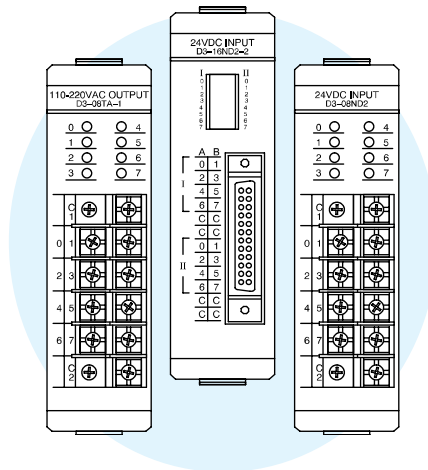

## Extra connectors or spare fuses

There are several types of spare parts that may be useful. A filler module provides a quick and easy way to cover empty slots. Or, it is sometimes helpful to have extra I/O module connectors or spare fuses. Also, keep in mind the DINnectors family of terminal blocks that provide DIN rail-mounted terminal blocks for simplifying and organizing your wiring needs.

- **D3-8IOCVR** – 8pt. I/O terminal plastic covers \$17.00
- **D3-FUSE-4** – Fuses for D3-08TAS, D3-08TAS-1, F3-16TA-1 and F3-16TA -2 \$23.00
- **D3-FUSE-6** – Fuses for F3-08TRS-2 \$23.00
- **D3-ACC-3** – Spare terminal screws for 16pt. I/O modules \$26.00

## ZIPLink Connection System

If your application requires a lot of relay outputs, consider using the ZipLink AC or DC relay output modules. These modules can switch high current (10A) loads without putting a load on your base power budget. Refer to the Terminal Blocks and Wiring Solutions section in this catalog for more information.

This logo is placed next to the I/O modules that are supported by the **ZIPLink** connection systems. See the I/O module specifications at the end of this section.

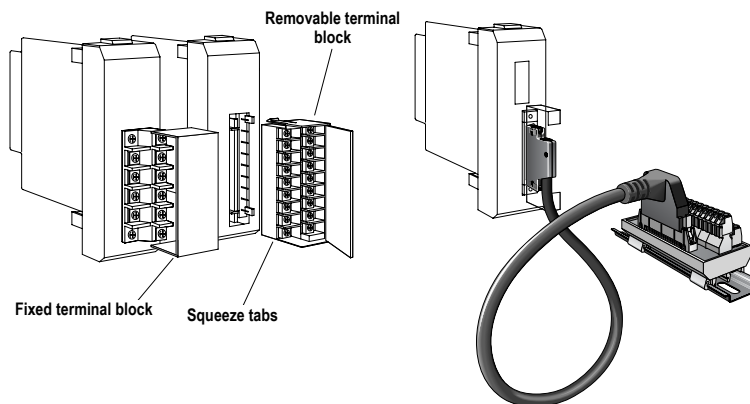

**ZIPLinks eliminate the tedious process of wiring PLC I/O terminal blocks.**

# DL305 I/O Configuration

**Local I/O** – Local I/O are the modules that reside in the same base as the CPU. The status of each I/O point is updated on each I/O scan of the CPU.

**Local expansion I/O** – Most local CPU bases can be expanded to include expansion I/O. Local expansion is commonly used when there are not enough I/O points available in the existing base configuration or the power budget maximum for the existing base will be exceeded with the addition of I/O. This configuration requires an additional base(s) and an I/O expansion cable(s). The CPU treats the expanded I/O in the same manner as local I/O, with updates every CPU I/O scan. There are certain addressing restrictions that are related to expansion I/O.

**Remote I/O** – (D3-350 CPU) – Remote I/O is used when you need to place I/O bases at some remote distance from the CPU base. There are certain restrictions that are related to remote I/O. Check the catalog section on DL205 Remote I/O for examples and additional information.

I/O Configuration Limitations	D3-350	D3-350 with -1 bases (AC powered only)
<b>5-slot Local CPU Base System</b>	64 I/O max	64 I/O max
<b>5-slot Local CPU Base System with a 5-slot Expansion Base</b>	128 I/O max	144 I/O max
<b>5-slot Local CPU Base System with two 5-slot Expansion Bases</b>	128 I/O max	224 I/O max
<b>10-slot Local CPU Base System</b>	136 I/O max	144 I/O max
<b>10-slot Local CPU Base System with a 5-slot Expansion Base</b>	176 I/O max	224 I/O max
<b>10-slot Local CPU Base System with a 10-slot Expansion Base</b>	184 I/O max	304 I/O max

*Note: The 16-point modules must be in the first eight slots adjacent to the CPU, rolling over into an expansion base if necessary.*

## Example of I/O system with expansion I/O

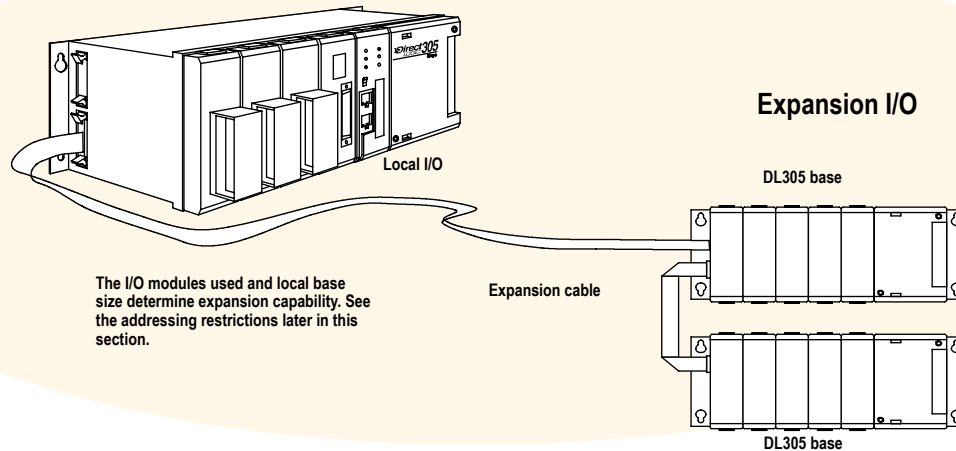

# I/O Module Locations

The design of the DL305 has a long and successful history. Each time the product family has grown or been enhanced, compatibility with the earlier products has been preserved to protect customer investments. This has resulted in an I/O numbering system and I/O location scheme that has some special requirements.

The Module Placement Guideline table explains the rules that pertain to module location. Some specialty modules have additional requirements. These are explained in their respective module data sheets. Remember that the power budget will limit the location where some modules can be placed in a base.

Module Placement Guidelines	
<b>Device</b>	Placement
<b>CPU</b>	<ul style="list-style-type: none"> <li>The CPU must reside in the first slot of the local CPU base (closest to the power supply).</li> <li>The CPU slot does consume an I/O slot. For example, a D3-05BDC 5-slot base has a slot for the CPU and 4 slots for I/O modules.</li> </ul>
<b>16 Point I/O Modules</b>	A maximum of eight 16-point modules may be installed in a system. However, the actual number allowed depends on the type of CPU you are using. D3-350 - maximum of eight 16-pt. modules D3-350 - w/-1 base can have 16-pt. modules in all available slots
<i>Note: some specialty modules, such as the High Speed Counter and Thumbwheel Interface Unit, require 16 points and are treated as 16-point modules. The 16-point modules must be in the first 8 slots adjacent to the CPU. They may roll over into an expansion base if necessary. If any of the 8 slots adjacent to the CPU are not used for 16-point modules, they can be used for 8-point modules.</i>	
<b>Analog</b>	Analog modules must reside in any valid 16-point I/O module slot.
<b>ASCII BASIC Modules</b>	ASCII BASIC modules can be placed in any valid 16-point I/O slot. (D3-350 does not support these modules)
<b>High Speed Counter</b>	A High-Speed Counter must be used in the first four I/O module slots in the local CPU base. (D3-350 does not support these modules)

I/O Points Usage Table for Modules					
The following table indicates the number of I/O points that are used by each module. Use this information to ensure your I/O configuration stays within the valid I/O count of your chosen CPU.					
DC Input		Relay Output		Analog	
<b>F3-16ND3F</b>	16	<b>F3-08TRS-1</b>	8	<b>F3-04ADS</b>	16
		<b>F3-08TRS-2</b>	8		
AC/DC Input					
<b>D3-08NE3</b>	8				



# D3-350 Addressing

## I/O addressing

When the I/O modules are installed in a 5-slot base and all expansion bases are also 5-slot bases, the addressing scheme is very simple. 16 I/O points are assigned to each slot. This applies even if the slot contains an 8-point module or if the slot is empty. Expansion base addresses follow in succession from the previous base. Input modules are assigned addresses X0 through X777. Output modules are assigned address Y0 through Y777.

5-slot base using 8-pt. I/O modules

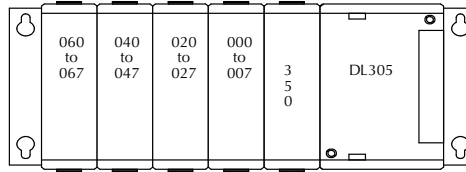

5-slot base using 16-pt. I/O modules

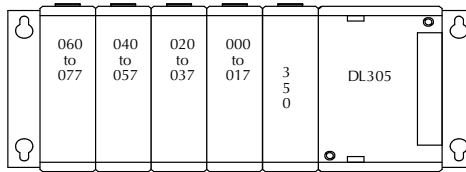

**D3-350 and F3-PMUX-1 CPUs, D3-232-DCU and all DL305 series bases have been retired. Please consider integrating to our Productivity, BRX, or CLICK PLC systems.**

## 5-Slot Base Example Configurations

### 5-Slot bases

5-slot local  
Total I/O: 64

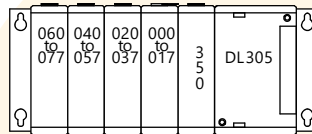

5-slot local and two 5-Slot expansions  
Total I/O: 224

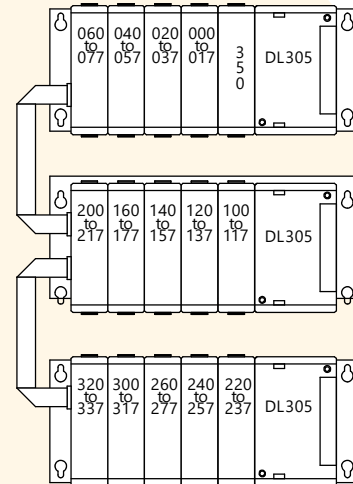

5-slot local and 5-slot expansions  
Total I/O: 144

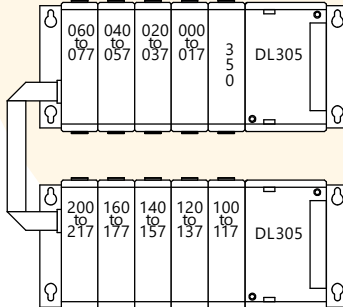

## 10-Slot Base Example Configurations

10-slot local and 5 slot expansion  
Total I/O: 224

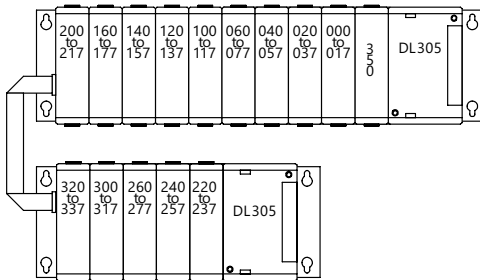

### 10-slot bases

10 slot local and 10 slot expansion  
Total I/O: 304

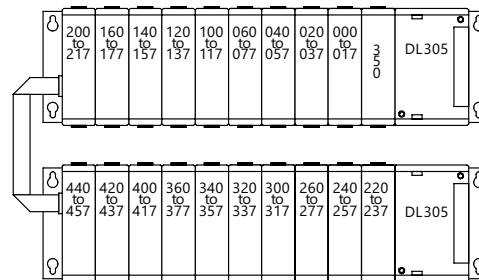

10 slot local  
Total I/O: 144

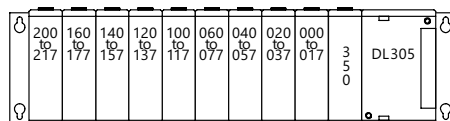

# Power Budget

## Managing your power resource

The I/O configuration depends on your choice of I/O modules, bases and I/O location. When determining the types and quantity of I/O modules you will be using, it's important to remember there is a limited amount of power available from the power supply.

The chart on the next page indicates the power supplied and used by each DL305

device. The adjacent chart shows an example of how to calculate the power used by your particular system. These two charts should make it easy for you to determine if the devices you have chosen fit within the power budget of your system configuration.

If the I/O you have chosen exceeds the maximum power available from the power

supply, you can resolve the problem by shifting some of the modules to an expansion base.

**WARNING: IT IS EXTREMELY IMPORTANT TO CALCULATE THE POWER BUDGET CORRECTLY. IF YOU EXCEED THE POWER BUDGET, THE SYSTEM MAY OPERATE IN AN UNPREDICTABLE MANNER, WHICH MAY RESULT IN A RISK OF PERSONAL INJURY OR EQUIPMENT DAMAGE.**

## Example: How to calculate your power usage

The following example shows how to calculate the power budget for the DL305 system. The examples are constructed around a single 5-slot base using the devices shown. It is recommended you construct a similar table for each base in your DL305 system.

- Using a chart similar to the one below, fill in column 2.
- Using the tables on the opposite page, enter the current supplied and used by each device (columns 3, 4, and 5). Devices which fall into the "Other" category (Row D) are devices such as the Handheld Programmer or a Data Communication Unit, which also have power requirements, but do not directly plug into the base.
- Add the current used by the system devices (columns 3, 4, and 5), starting with Slot 1, then put the total in the row labeled "Maximum Current Required" (Row E).
- Subtract the row labeled "Maximum Current Required" (Row E), from the row labeled "Current Supplied" (Row B). Place the difference in the row labeled "Remaining Current" (Row F).
- If "Maximum Current Required" is greater than "Current Supplied" in columns 3, 4 or 5, the power budget will be exceeded. It will be unsafe to use this configuration and you will need to restructure your I/O configuration.

## Use ZIPLinks to reduce power requirements

If your application requires a lot of relay outputs, consider using the ZIPLink AC or DC relay output modules. These modules can switch high current (10A) loads without putting a load on your base power budget. Refer to the Wiring Solutions section in this catalog for more information.

This logo is placed next to I/O modules that are supported by the ZipLink connection systems. See the I/O module specifications at the end of this section.



### Example of System Power Requirements Calculation

A	Column 1	Column 2	Column 3	Column 4	Column 5
	Base # 0	Device Type	5 VDC (mA)	9VDC (mA)	24V(mA)
<b>B</b>	<b>Current Supplied</b>				
	5-slot Base	<a href="#">D3-05BDC</a>	1400	800	500
<b>C</b>	<b>Current Required</b>				
	CPU Slot	<a href="#">D3-350</a>	500	0	0
	Slot 0	<a href="#">D3-16NE3</a>	0	130	0
	Slot 1	<a href="#">D3-16NE3</a>	0	130	0
	Slot 2	<a href="#">F3-08TRS-1</a>	0	296	0
	Slot 3	<a href="#">F3-04DAS</a>	0	183	0
<b>D</b>	<b>Other</b>				
	Handheld prog D2-HPP		200	0	0
<b>E</b>	Maximum Current Required		700	739	0
<b>F</b>	Remaining Current		700	61	500

# DL305 Power Requirements

This section shows the amount of power supplied by the base power supplies and the amount of power used by each DL305 device. **Note** the base power supplies provide three internal voltages (5V, 9V, 24V). The chart shows how much power from each of these power sources is required for each DL305 device. Use this information when calculating the power budget for your system.

In addition to the three internal power sources, the DL305 bases provide an external power connection. There is 24VDC available from the 24VDC output terminals on the bases (except D3-05BDC and D3-10BDC).

The 24VDC can be used to power external devices or DL305 modules that require external 24VDC. The power used from this external 24VDC output reduces the internal system 24VDC that is available to the modules by an equal amount. When using the 24VDC output at the base terminal, do not exceed 100mA current draw.

Power Consumed				
Device	5V(mA)	9V(mA)	24V(mA)	Ext req.
<b>CPUs</b>				
<b>D3-350</b>	500	0	0	0
<b>DC Input Modules</b>				
<b>F3-16ND3F</b>	0	148	68	0
<b>AC/DC Input Modules</b>				
<b>D3-16NE3</b>	0	130	0	0

Power Supplied				
Device	5V(mA)	9V(mA)	24V(mA)	24 V (mA)
<b>D3-05BDC</b>	900	2000	500	None
<b>D3-10BDC</b>	900	2000	500	None
<b>Power Consumed</b>				
Device	5V(mA)	9V(mA)	24V(mA)	External required
<b>Relay Output Modules</b>				
<b>F3-08TRS-1</b>	0	296	0	0
<b>F3-08TRS-2</b>	0	296	0	0
<b>Analog Temperature and Thermocouple Modules</b>				
<b>F3-04ADS</b>	0	183	50	0
<b>Communications and Networking</b>				
<b>Programming</b>				
<b>D2-HPP</b>	200	0	0	0
<b>Specialty CPUs</b>				
<b>F3-0MUX-2</b>	262	0	150	0
<b>Operator Interface</b>				
<b>C-more Micro-Graphic</b>	210	0	0	0

# Dimensions and Installation

It is important to understand the installation requirements for your DL305 system. This will help ensure that the DL305 products operate within their environmental and electrical limits.

## Plan for safety

This catalog should never be used as a replacement for the user manual. The user manuals, D3-USER-M and D3-350-M (available for download from our web site), contain important safety information that must be followed. The system installation should comply with all appropriate electrical codes and standards.

## Base dimensions and mounting orientation

Use the diagrams to the right to make sure the DL305 system can be installed in your application. DL305 bases must be mounted horizontally to ensure proper airflow for cooling purposes. It is important to check these dimensions against the conditions required for your application. For example, it is recommended that you leave 1.5" depth for ease of access and cable clearance. However, your distance may be greater or less. Also, check the installation guidelines for the recommended cabinet clearances.

Specification	Rating
<b>Storage Temperature</b>	-4°F - 158°F (-20°C to 70°C)
<b>Ambient Operating Temperature</b>	32°F - 131°F (0° to 55°C)
<b>Ambient Humidity</b>	30% - 95% relative humidity (non-condensing)
<b>Vibration Resistance</b>	MIL STD 810C, Method 514.2
<b>Shock Resistance</b>	MIL STD810, Method 516.2
<b>Noise Immunity</b>	NEMA (ICS3-304)

DL305 mounting depths

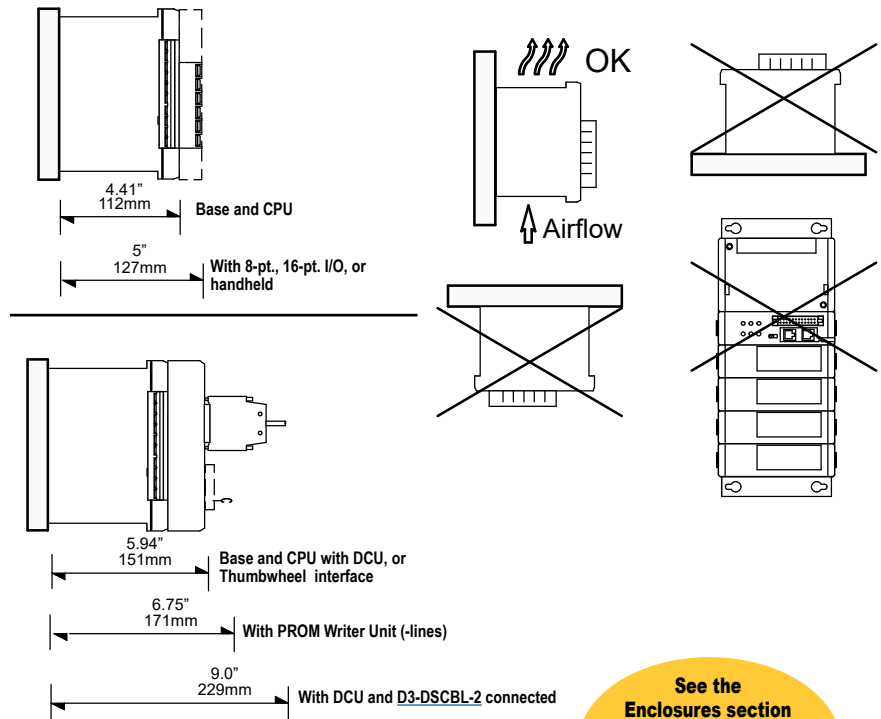

See the Enclosures section in this catalog for an enclosure that may be suitable for your application

