

DIRIS A

Power Measurement Devices



The new DIRIS A Power Measurement Devices offer extended functionality and enable you to...

Reduce costs. All industries are faced with the need to minimize operating and maintenance costs. In this kind of environment, the measurement system is a key component, enabling energy quality and costs to be monitored.

Reduce production losses. The measurement system is at the heart of any solution designed to prevent electrical incidents, or even production downtime, which often generate significant financial losses or material wastes.

Improve efficiency. The measurement system is a key factor in identifying malfunctions within the installation, which can then lead to improved energy efficiency. The DIRIS line of products allow you to detect where you consume the most and adapt your energy consumption.

Enhance performance. The accuracy class of the measurement units is essential in reducing energy consumption.

Enjoy unparalleled ease of use. Equipped with a large backlit screen, DIRIS A units display a number of key power system values, while remaining easy to view. The direct access keys (four to six depending on the model) enable optimum use of the available functions.

DIRIS units are easy to install. The Easy Config software can be used to quickly and easily create, edit and save configurations.

All units are equipped with an integrated test function that can be utilized to detect incorrect wiring and to automatically correct CT installation errors.



4825U20

4825U011

Features

Metering

Energy consumed by each building or manufacturing line, in order to distribute and optimize energy costs (multi-utility management)

Measuring

All electrical or analog values to verify that your facilities are working properly. DIRIS measurement units can measure and display more than 200 parameters with a very high-level of accuracy.

- Class 0.5 ANSI C12.20
- Class 0.5S IEC 62053-22

Monitoring

Electrical networks via alarm management, secure monitoring of distribution parameters and remote control of electrical apparatus. DIRIS meters allow you to analyze the quality of your network and to avoid the installation deterioration.

Analyzing

Energy quality via a detailed breakdown of harmonics identifying troughs, outages, overvoltages and overcurrents on the network.

Applications

- Industrial monitoring
- Energy monitoring in building automation systems
- Renewable energy
- Energy management
- Commercial sub-metering
- Cost allocation



Agency approvals: UL file # E257746, CE 2011/65/EU, 2014/35/EU LVD, 2014/30/EU EMC

DIRIS A Multifunction Meters



The DIRIS A10 is a modular DIN rail mountable multifunction meter for measuring electrical values in low voltage networks. It allows all electrical parameters to be displayed and utilized for communication and/or output functions.

The DIRIS A20 is a panel-mounted unit which gives you access to all the measurements required for successfully carrying out energy efficiency projects and ensuring the electrical distribution is monitored.

Features

- Easy to use solution for industry, infrastructure and data centers
- Integrated temperature sensor (on A10)
- Detects wiring errors

Listings

- Compliant with ANSI C12.20 and IEC 61557-12
- Conformity to standards IEC 61557-12, IEC 62053-22 class 0.5S, IEC 62053-23 class 2, UL 61010 File E257746 and ANSI C12.20

Advantages

Easy to use

A10: Five direct-access pushbuttons enable all measurements to be clearly viewed on its backlit LCD display. Unit is DIN rail mountable.

A20: Thanks to its large backlit LCD display and its multiple viewing screens with direct pushbutton access, DIRIS A20 multifunction meters directly display a number of multi-measurement and metering values: +kWh, +kvarh, I, U, V, F, P, Q, S, PF, etc. Designed for panel mounting.

Integrated temperature sensor (on A10)

Allows variations in temperature to be detected.

Detects wiring errors

An integrated test function can be utilized to detect incorrect wiring and to automatically correct CT installation errors.

Compliant with ANSI C12.20 and IEC 61557-12

IEC 61557-12 is a high-level standard for all Performance Monitoring Devices (PMDs) that are designed to measure and monitor electrical parameters in distribution networks. Compliance with IEC 61557-12 ensures a high level of equipment performance, in terms of metrology, and the mechanical and environmental aspects (EMC, temperature, etc.)



Principle Diagram

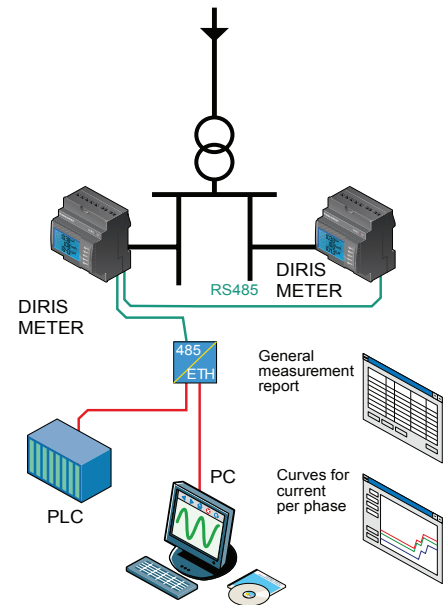

DIRIS A Multifunction Meters				
Part Number	Description	Operating Voltage	Frequency	Price
4825U010	DIN rail mount multifunction meter with backlit LCD display. Without RS485.	110-277 VAC	50/60 Hz	\$315.00
4825U011	DIN rail mount multifunction meter with backlit LCD display. With RS485.	110-277 VAC	50/60 Hz	\$366.00
4825U200	Panel mount multifunction meter with backlit LCD display.	110-240 VAC 120-250 VDC	50/60 Hz	\$437.00

Functions

Multi-measurement

Currents

- Instantaneous: I1, I2, I3, In
- Maximum average: I1, I2, I3, In

Voltages & frequency

- Instantaneous: V1, V2, V3, U12, U23, U31, F

Power

- Instantaneous: 3P, ΣP, 3Q, ΣQ, 3S, ΣS
- Maximum average: ΣP, ΣQ, ΣS

Power factors

- Instantaneous: 3PF, ΣPF

Metering

- Active energy: +kWh
- Reactive energy: +kvarh
- Hours
- Harmonic analysis

Harmonic analysis

Total Harmonic Distortion (level 51)

- Currents: thd1, thd I2, thd I3
- Phase-to-neutral voltage: thd V1, thd V2, thd V3
- Phase-to-phase voltage: thd U12, thd U23, thd U31

Dual tariff function (A10)

Selection of one out two billing tariffs

Events

Alarms on all electrical values

Communications

RS485 with MODBUS protocol

Input

- Tariff selection (A10)
- Remote device status

Output

- Remote command of device
- Alarm output
- Pulse output

DIRIS A10 Multifunction Meter

Electrical Characteristics

Current Measurement (TRMS)	
Via CT primary	9,999A
Via CT secondary	5A
Measurement range	0-11 kA
Input consumption	0.6 VA
Measurement updating period	1s
Accuracy	0.2%
Permanent overload	6A
Intermittent overload	10 In for 1s
Voltage Measurement (TRMS)	
Direct measurement between phases	50-500 VAC
Direct measurement between phase and neutral	28-289 VAC
Input consumption	≤ 0.1VA
Measurement updating period	1s
Accuracy	0.2%
Permanent overload	800VAC
Power Measurement	
Measurement updating period	1s
Accuracy	0.5%
Power Factor Measurement	
Measurement updating period	1s
Accuracy	0.5%
Frequency Measurement	
Measurement range	45-65 Hz
Measurement updating period	1s
Accuracy	0.1%
Energy Accuracy	
Active (according to IEC 62053-22)	Class 0.5 S
Reactive (according to IEC 62053-23)	Class 2
Metrological LED (EA+)	
Pulse weight	10,000 pulses/kWh
Color	Red
Auxiliary Power Supply	
Alternating voltage	110-277 VAC
AC tolerance	±15%
Frequency	50/60 Hz
Consumption	<3VA
Digital Output (Pulse or Alarm)	
Number	1
Type	20/30 VDC; 0.5 A, 10VA
Max. number of operations	≤10 ⁸
Input (tariff)	
Number	1
Tariff Pricing Tiers (T1, T2)	0 VAC:T1 / 100-277 VAC:T2
Communication	
Link	RS485
Type	2-3 half duplex wires
Protocol	MODBUS RTU
MODBUS speed	2400-38400 baud
Operating Conditions	
Operating temperature	+14 to +131° F / -10 to +55° C
Storage temperature	-4 to +158° F / -20 to +70° C
Relative humidity	85%

Front panel

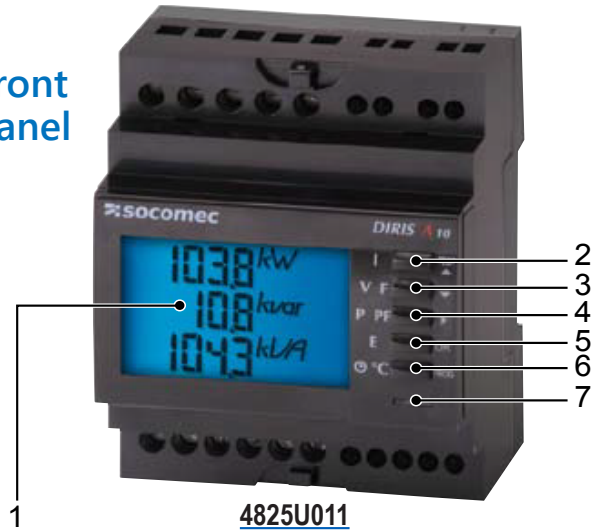

1. Backlit LCD display.
2. Direct access key for currents (instant and maximum), current THD and test function.
3. Direct access key for voltages, frequency and voltage THD.
4. Direct access key for active, reactive and apparent power (instantaneous and max. values) and power factor.
5. Direct access key for energies.
6. Pushbutton for hour meter, temperature and programming menu access.
7. Metrological LED (energy metering indication).

Case dimensions

Inches [mm]

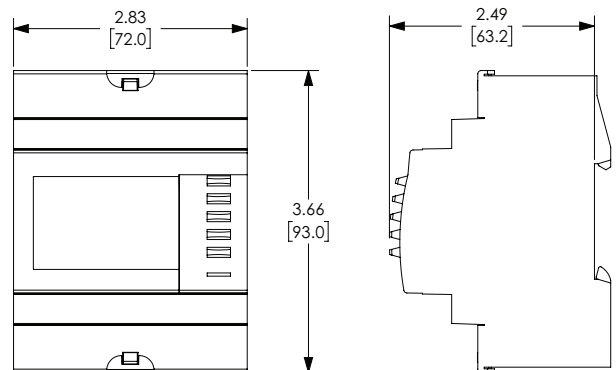

Physical characteristics	
Type	Modular
Case degree of protection	IP30
Front degree of protection	IP52
Display type	Backlit LCD display, blue background
Character size and type	4 characters, black, 8mm (0.31 in.)
Voltage and current connection cross-section	AWG 12 (4 mm ²)
Connection cross-section for AUX supply, input, output and comms	AWG 14 (2.5 mm ²)
Weight	7.23 oz./205g (4825 U010) 7.58 oz./215g (4825 U011)

DIRIS A10 Multifunction Meter



Terminals

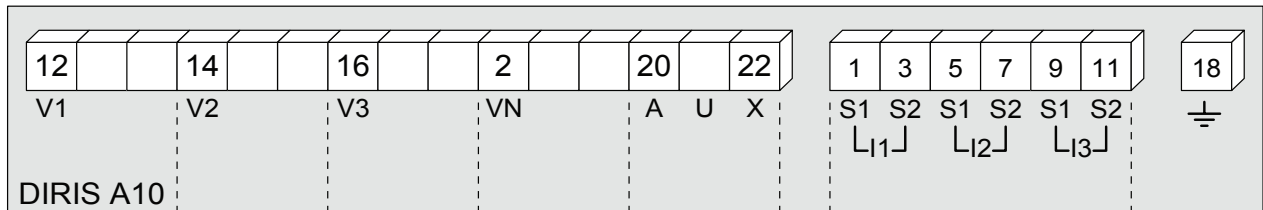

AUX: Auxiliary power supply U_S
V1, V2, V3 & VN: voltage inputs

S1-S2: Current inputs

Communication terminals

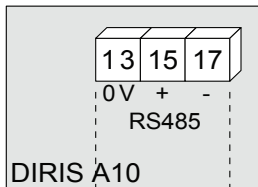

RS485 link

Pulse or alarm output terminals

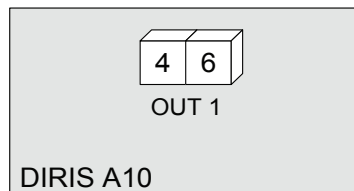

4-6: Output

Input terminals

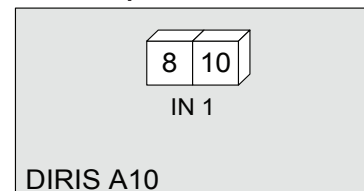

8-10: Input

DIRIS A10 Multifunction Meter



Connection

CAUTION:

- For IT grounding systems, it is recommended that the CT secondary is not connected to ground.
- When disconnecting the DIRIS, the secondary of each current transformer must be short-circuited. This operation can be carried out using AutomationDirect's KN-2JM10 shorting jumpers and KN-KBD10 terminal blocks.
- It is recommended that the grounding point for DIRIS A10 and the current transformer secondaries are not grounded at the same time.

Low voltage balanced network

3/4 wires with 1 CT

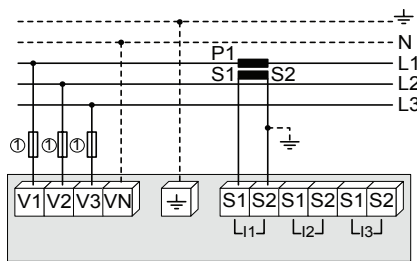

1. Fuses 0.5A gG / 0.5A class CC

Single-phase

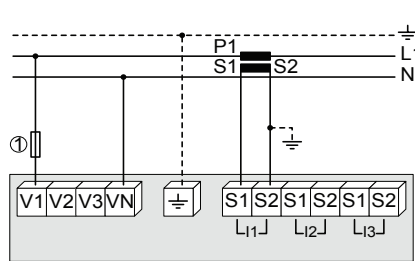

1. Fuses 0.5A gG / 0.5A class CC

Two phase

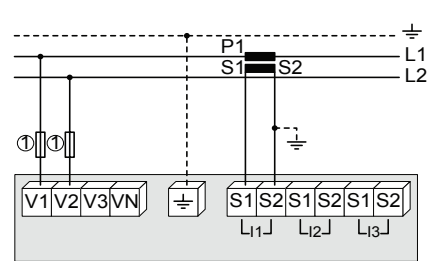

1. Fuses 0.5A gG / 0.5A class CC

Low voltage unbalanced network

3/4 wires with 3 CTs

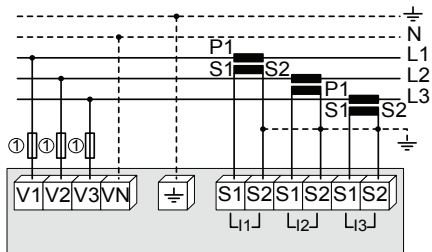

1. Fuses 0.5A gG / 0.5A class CC

3 wires with 2 CTs

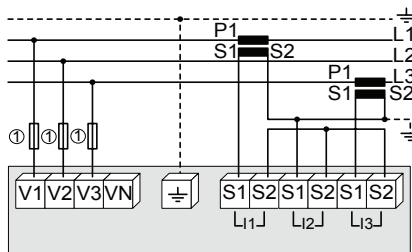

Use of 2 CTs reduces by 0.5% the accuracy of the phases, the current of which is worked out by vector calculation.

1. Fuses 0.5A gG / 0.5A class CC

3 wires with 2CTs

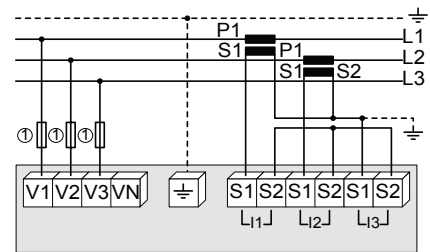

Use of 2 CTs reduces by 0.5% the accuracy of the phases, the current of which is worked out by vector calculation.

1. Fuses 0.5A gG / 0.5A class CC

Additional information

Communication via RS485 link

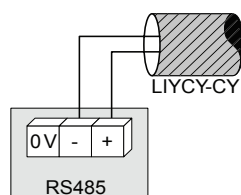

AC auxiliary power supply

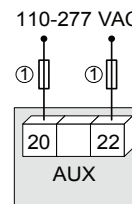

1. Fuses 0.5A gG / 0.5A class CC

DIRIS A20 Multifunction Meter



Electrical Characteristics

Current Measurement (TRMS)	
Via CT primary	9,999 A
Via CT secondary	5A
Measurement range	0-11 kA
Input consumption	0.6 VA
Measurement updating period	1s
Accuracy	0.2%
Permanent overload	6A
Intermittent overload	10 I _n for 1s
Voltage Measurement (TRMS)	
Direct measurement between phases	50-500 VAC
Direct measurement between phase and neutral	28-289 VAC
Input consumption	≤ 0.1 VA
Measurement updating period	1s
Accuracy	0.2%
Permanent overload	800VAC
Power Measurement	
Measurement updating period	1s
Accuracy	0.5%
Power Factor Measurement	
Measurement updating period	1s
Accuracy	0.5%
Frequency Measurement	
Measurement range	45-65 Hz
Measurement updating period	1s
Accuracy	0.1%
Energy Accuracy	
Active (according to IEC 62053-22)	Class 0.5 S
Reactive (according to IEC 62053-23)	Class 2
Auxiliary Power Supply	
Alternating voltage	110-240 VAC
AC tolerance	+/-10%
Direct voltage	120-250 VDC
DC tolerance	+/-20%
Frequency	50/60 Hz
Consumption	10VA
Digital Output, optional module (Pulse or Alarm)	
Number	1
Type	100VDC; 0.5A; 10VA
Max. number of operations	≤ 10 ⁸
Communication	
Link	RS485
Type	2-3 half duplex wires
Protocol	Modbus RTU
MODBUS® speed	1400-38400 baud
Operating Conditions	
Operating temperature	+14 to +131° F / -10 to +55° C
Storage temperature	-4 to +185° F / -20 to +85° C
Relative humidity	95%

Front panel



- 1 Backlit LCD display.
2. Direct access for currents (instantaneous and max. values), current THD and test function.
3. Direct access key for voltages, frequency and voltage THD.
4. Pushbutton for active, reactive, and apparent power (instantaneous and max. values) and power factor.
5. Direct access key for energies, hour meter and programming menu.

Case dimensions

Inches [mm]

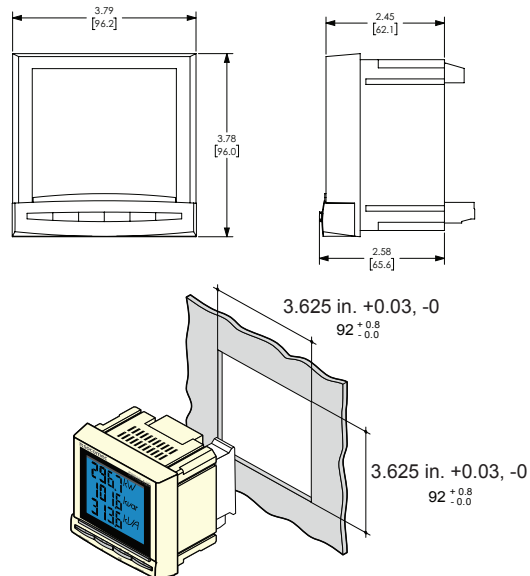

Please see our website www.AutomationDirect.com for complete engineering drawings.

Physical characteristics	
Type	Panel mounting
Case degree of protection	IP30
Front degree of protection	IP52
Display type	Backlit LCD display, blue background
Character size and type	4 characters, black, 15mm (0.59 in.)
Terminal block type	Fixed or plug-in
Voltage and other connection cross-section	AWG 24-14 (0.2-2.5 mm ²)
Current connection cross-section	AWG 20-10 (0.5-6 mm ²)
Weight	14.11 oz / 400 g

DIRIS A20 Multifunction Meter



Plug-in Modules



4825U200



48250080

1 Output

- 1 output assignable to:
 - Pulses: configurable (type, weight, duration) in kWh or kvarh
 - Monitoring: 3I, In, 3V, 3U, F, ΣP, ΣQ, ΣS, ΣPFL/C, THD 3I, THD 3V, THD 3U and timer
 - Remote command of device



48250082

Communication

- RS485 link with JBUS/Modbus RTU protocol (speed up to 38400 baud)

DIRIS A20 (4825U200) Plug-in Modules			
Part Number	Description	Module type	Price
48250080	Optional configurable output module for the DIRIS A20	Output	\$68.00
48250082	Optional Modbus RTU (RS485) communications module for the DIRIS A20	Communication	\$62.00

Note: Diris A20 can accept a maximum of two plug-in modules.

Terminals

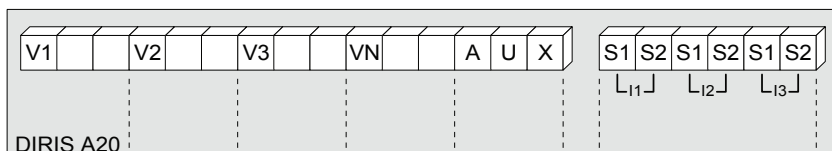

S1, S2: Current inputs

AUX: Auxiliary power supply U_S
V1, V2, V3 and Vn: voltage inputs

Communication module

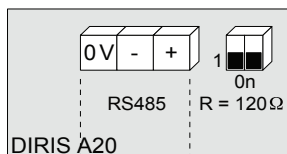

RS485 link
R=120Ω: Selectable internal resistance for RS485 end of line termination

Pulse output or alarm module

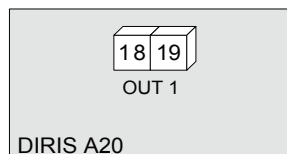

18-19: Output

DIRIS A20 Multifunction Meter



Connection

CAUTION:

- For IT grounding systems, it is recommended that the CT secondary is not connected to ground.
- When disconnecting the DIRIS, the secondary of each current transformer must be short-circuited. This operation can be carried out using AutomationDirect's KN-2JM10 shorting jumpers and KN-KBD10 terminal blocks.

Low voltage balanced network

3/4 wires with 1 CT

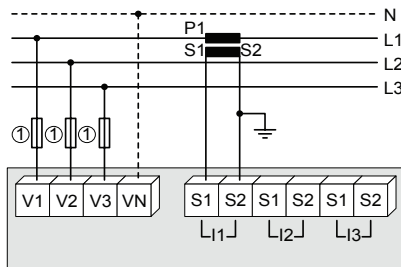

Use of 1 CT reduces by 0.5% the accuracy of the phases, the current of which is worked out by vector calculation.

1. Fuses 0.5A gG / 0.5A class CC

Single-phase

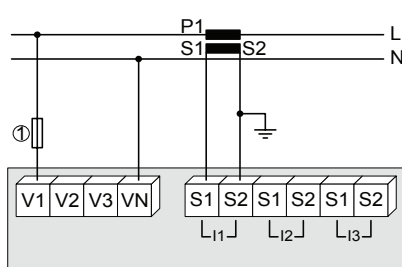

1. Fuses 0.5A gG / 0.5A class CC

Two phase

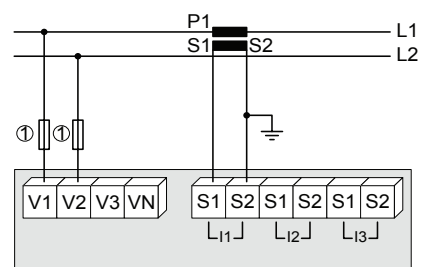

1. Fuses 0.5A gG / 0.5A class CC

Low voltage unbalanced network

3/4 wires with 3 CTs

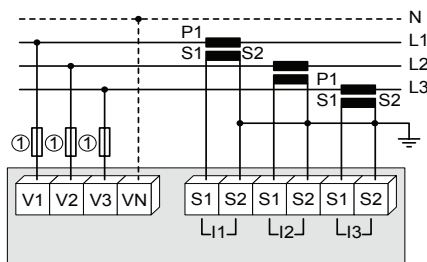

1. Fuses 0.5A gG / 0.5A class CC

3 wires with 2 CTs

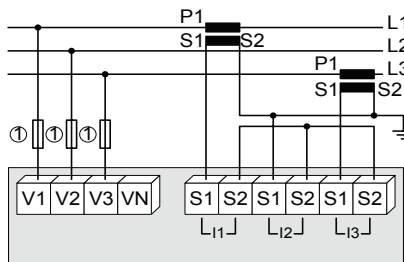

Use of 2 CTs reduces by 0.5% the accuracy of the phases, the current of which is worked out by vector calculation.

1. Fuses 0.5A gG / 0.5A class CC

2 wires with 2 CTs

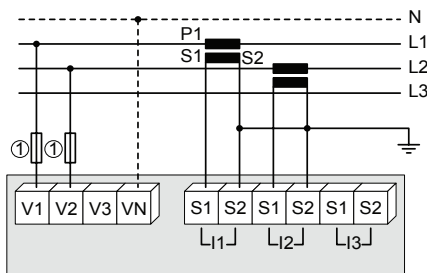

1. Fuses 0.5A gG / 0.5A class CC

3 wires with 2CTs

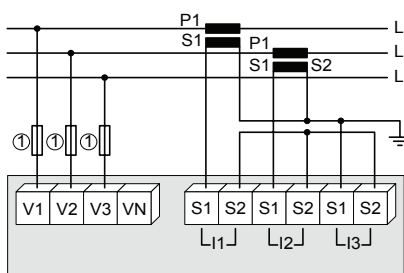

Use of 2 CTs reduces by 0.5% the accuracy of the phases, the current of which is worked out by vector calculation.

1. Fuses 0.5A gG / 0.5A class CC

Additional information

Communication via RS485 link

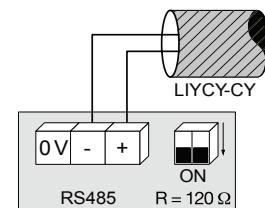

AC & DC auxiliary power supply

110 / 240 VAC
120 / 250 VDC

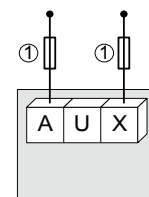

1. Fuses 0.5A gG / 0.5A class CC

DIRIS Multifunction Meters



Dimensions

Inches [mm]

4825U01x DIRIS A10 DIN Rail Mount Multifunction Meter (inches [mm])

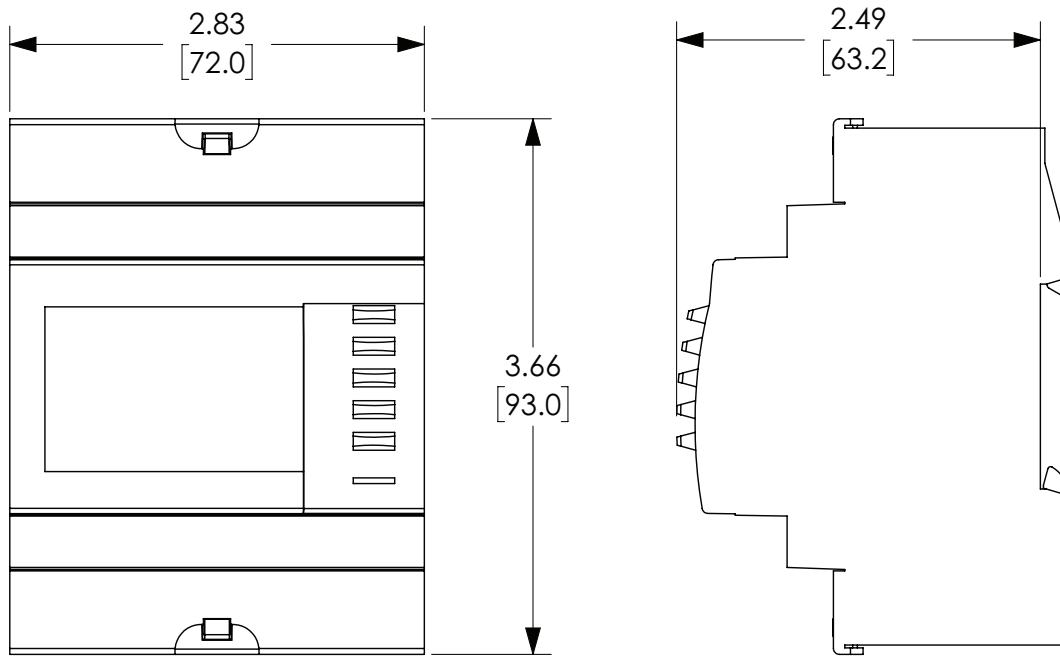

4825U200 DIRIS A20 Panel Mount Multifunction Meter (inches [mm])

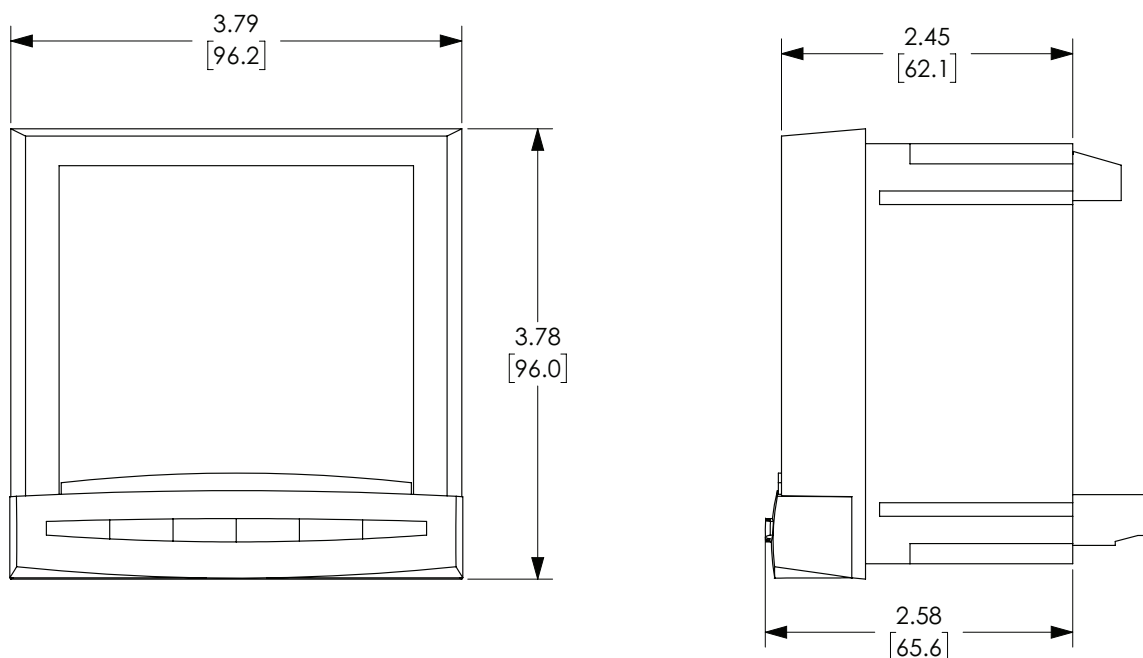

Please see our website www.AutomationDirect.com for complete engineering drawings.

DIRIS Multifunction Meters



Dimensions

Inches [mm]

48250080 Optional Output Module for DIRIS A20

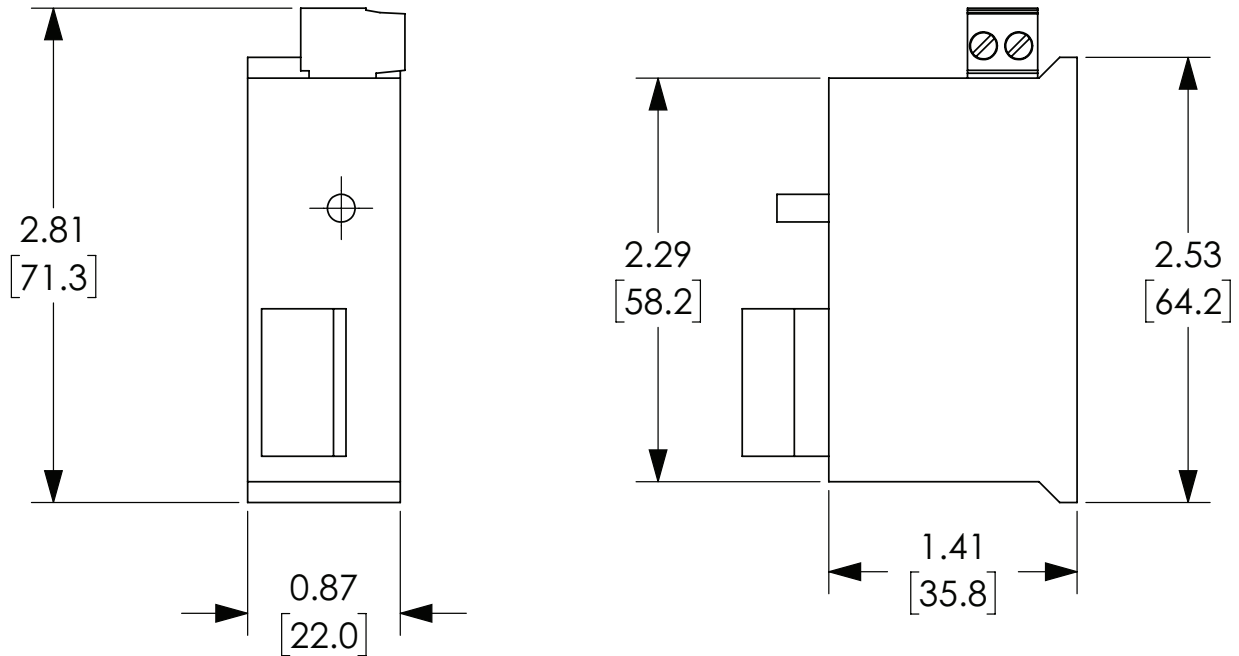

48250082 Optional RS485 Module for DIRIS A20

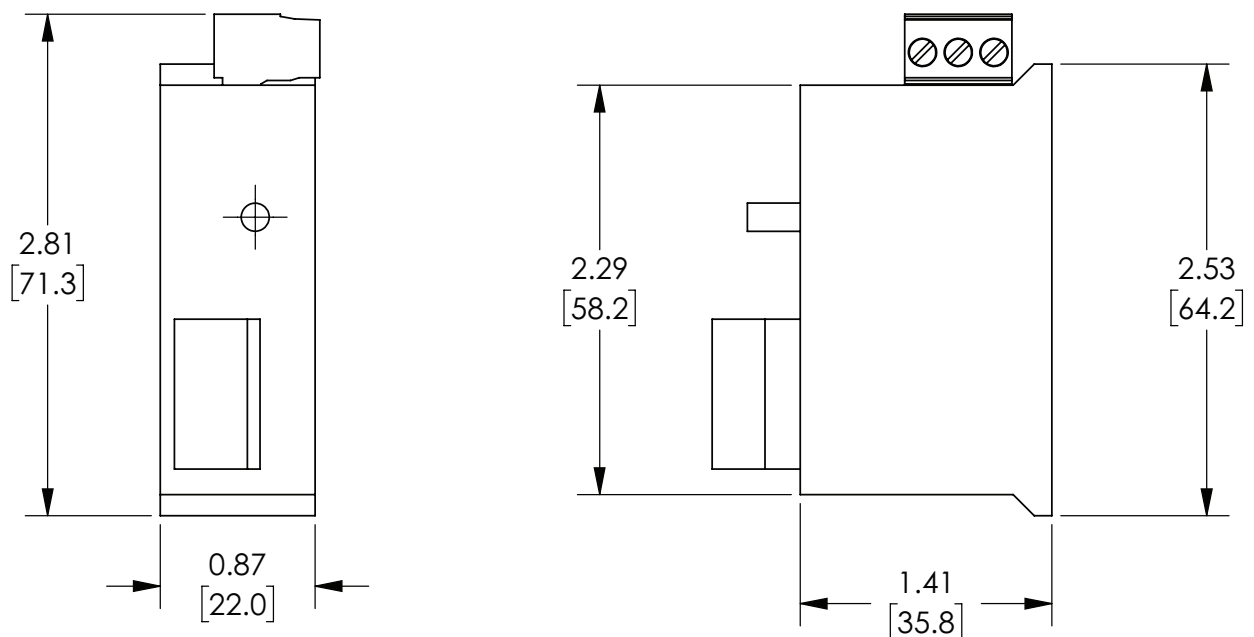

Please see our website www.AutomationDirect.com for complete engineering drawings.