



Plug-In Terminal Blocks

Single and double level DN-EMXxx plug-in terminal blocks with screw terminals accept all DN-xxPLUG(MN) Euro plugs and are 35mm DIN rail mountable.



(4) DN-EMXM1
Series: EURO XM1/2V 2.5/35

(4) DN-EMXM1 with
(2) DN-4PLUG

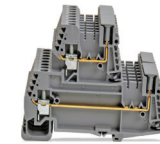
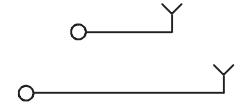

(4) DN-EMXDV
Series: EURO XDV 2.5/35



(4) DN-EMXDV with
(2) DN-4PLUG

Ordering Information							
Color	Part Number	Qty	Price	Part Number	Qty	Price	
Gray	DN-EMXM1	32	\$53.00	DN-EMXDV	32	\$78.00	
Technical Specifications							
Stripping Length	8mm [0.31 in]			8mm [0.31 in]			
Tightening Torque	0.45 N·m [4 lb·in]			0.45 N·m [4 lb·in]			
UL Approval*	300V	12A	24-12 AWG	300V	12A	24-12 AWG	
Operating Temperature	Ambient air temperature: -20 to 105°C [-4 to 221°F] Relative humidity: 50% max at 40°C [104°F]; 90% max at 20°C [68°F]						
SCCR Rating	10kA per Table SB4.1, 2009, UL 508A, Maximum short circuit current rating for unmarked components						
CE Conformity	CE (EN 60947-1 / EN 60947-7-1)						
Agency File #	UL E179129						
Accessories							
End Cover	left (open) side	DN-EMXM1EC1	25	\$15.00	DN-EMXDVEC1	25	\$15.00
	right (closed) side	DN-EMXM1EC2	25	\$15.00	DN-EMXDVEC2	25	\$15.00
Spacer	Either side	DN-EMXM1SPA1	25	\$13.00	DN-EMXDVSPA1	25	\$14.50
35mm DIN Rail	7.5 mm high	DN-R35S1	10	\$39.00	DN-R35S1	10	\$39.00
		DN-R35S1-2	2	\$11.00	DN-R35S1-2	2	\$11.00
	15mm high	DN-R35HS1	10	\$68.00	DN-R35HS1	10	\$68.00
		DN-R35HS1-2	2	\$16.50	DN-R35HS1-2	2	\$16.50
Jumpers**	2-pole	DN-2J2Y	100	\$43.00	DN-2J2Y	100	\$43.00
		DN-2J2YMN	25	\$13.00	DN-2J2YMN	25	\$13.00
	3-pole	DN-3J2Y	100	\$62.00	DN-3J2Y	100	\$62.00
		DN-3J2YMN	25	\$18.00	DN-3J2YMN	25	\$18.00
	24-pole	DN-24J2Y	1	\$28.00	DN-24J2Y	1	\$28.00
	Jumper Cutting Tool**	DN-J2CUT	1	\$79.00	DN-J2CUT	1	\$79.00
Pin Protector – 4-pole	DN-EMPEG1	Each piece covers and protects up to 4 unused pins				\$4.00	
End Brackets	DN-EB35	50	\$67.00	DN-EB35	50	\$67.00	
	DN-EB35MN	20	\$31.50	DN-EB35MN	20	\$31.50	
	DN-EB35-A	50	\$47.50	DN-EB35-A	50	\$47.50	
	DN-EB35-A-10	10	\$12.00	DN-EB35-A-10	10	\$12.00	
	DN-QEB35	50	\$42.50	DN-QEB35	50	\$42.50	
	DN-QEB35-10	10	\$11.50	DN-QEB35-10	10	\$11.50	
Marking Tags	DN-LA, DN-LT, or DN-EMLBL	500/100	various	DN-LA, DN-LT, or DN-EMLBL	500/100	various	

* For copper wire only

** Jumper Cutting Tool **DN-J2CUT** cuts DN-xJ2Y Series multi-pole jumpers and MAINTAINS THE INSULATION

For more information on accessories, see the DINnectors Accessories section of this chapter.

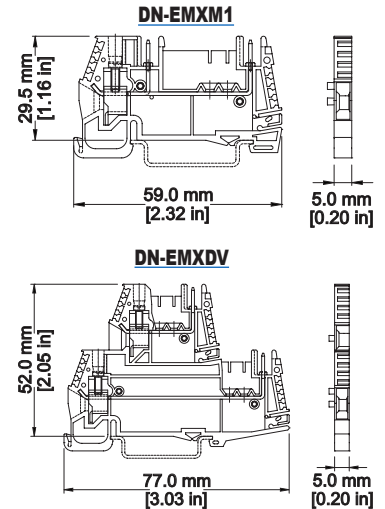

Accessories – Terminal Plugs									
*Part Number	Number of Poles	Length in [mm]	Qty	Price	*Part Number	Number of Poles	Length in [mm]	Qty	Price
DN-2PLUG	2	0.40 [10.2]	200	\$115.00	DN-8PLUG	8	1.60 [40.6]	50	\$117.00
DN-2PLUGMN			10	\$7.25	DN-8PLUGMN			5	\$14.50
DN-3PLUG	3	0.60 [15.2]	200	\$177.00	DN-9PLUG	9	1.80 [45.7]	50	\$128.00
DN-3PLUGMN			10	\$11.50	DN-9PLUGMN			5	\$15.00
DN-4PLUG	4	0.80 [20.3]	100	\$118.00	DN-10PLUG	10	2.00 [50.8]	50	\$136.00
DN-4PLUGMN			10	\$14.50	DN-10PLUGMN			5	\$17.00
DN-5PLUG	5	1.00 [25.4]	100	\$136.00	DN-11PLUG	11	2.20 [55.9]	50	\$161.00
DN-5PLUGMN			10	\$18.00	DN-11PLUGMN			5	\$19.50
DN-6PLUG	6	1.20 [30.5]	100	\$176.00	DN-12PLUG	12	2.40 [61.0]	50	\$176.00
DN-6PLUGMN			10	\$18.00	DN-12PLUGMN			5	\$20.00
DN-7PLUG	7	1.40 [35.6]	50	\$92.00					
DN-7PLUGMN			5	\$14.50					

* DN-xxPLUGs fit all DN-EMXxx & DN-QEMXxx plug-in terminal blocks.

Terminal Plugs Ratings	
Voltage/Current	300V, 12A
Wire Gauge	14–22 AWG, CU only
Torque	Tightening Torque: 0.51 N·m [4.5 lb·in]
Operating Temperature	Ambient air temp: -20 to 105°C [-4 to 221°F] Relative humidity: 50% max at 40°C [104°F]; 90% max at 20°C [68°F]
Agency Approvals	UL file #: E179129

DINnectors® Accessories

Marking Tags Cross Reference Charts - Screw-type

DINector Marking Tags Cross Reference - Screw-type					
<i>Block Type</i>	<i>DN-L</i>	<i>DN-LA</i>	<i>DN-LT</i>	<i>DN-LAT</i>	<i>DN-EMLBL</i>
<i>DN-T12</i>	-	X	X	-	-
<i>DN-T10</i>	X	-	X	-	-
<i>DN-T8</i>	X	-	X	-	-
<i>DN-T6</i>	X	-	X	-	-
<i>DN-T4</i>	X	-	X	-	-
<i>DN-T1/0</i>	X	-	X	-	-
<i>DN-T3/0</i>	X	-	X	-	-
<i>DN-D10</i>	X	-	X	-	-
<i>DN-D10X</i>	X	-	X	-	-
<i>DN-D10LED</i>	X	-	X	-	-
<i>DN-D10DR</i>	X	-	X	-	-
<i>DN-TL14</i>	-	-	-	X	-
<i>DN-THERM</i>	X	-	X	-	-
<i>DN-EMXM1</i>	-	X	X	-	X
<i>DN-EMXDV</i>	-	X	X	-	X
<i>DN-M10</i>	-	-	X	-	-
<i>DN-MG10</i>	-	-	X	-	-
<i>DN-G10</i>	X	-	X	-	-
<i>DN-G8</i>	X	-	X	-	-
<i>DN-G6</i>	X	-	X	-	-
<i>DN-G4</i>	X	-	X	-	-
<i>DN-G1/0</i>	X	-	X	-	-
<i>DN-F6</i>	X	-	X	-	-
<i>DN-F10</i>	X	-	X	-	-
<i>DN-DIS2</i>	-	X	X	-	-
<i>DN-DIS4</i>	X	-	X	-	-
<i>DN-FE2</i>	-	X	X	-	-
<i>DN-FE4</i>	X	-	X	-	-
<i>DN-DIS10</i>	X	-	X	-	-
<i>DN-KBD12</i>	-	X	X	-	-

Continued on next page



DINnectors Accessories

Marking Tags Cross Reference Charts - Screwless

DINector Marking Tags Cross Reference - Screwless				
<i>Block Type</i>	<i>DN-QL</i>	<i>DN-LA</i>	<i>DN-LT</i>	<i>DN-EMLBL</i>
<i>DN-Q12</i>	X	-	-	-
<i>DN-Q10</i>	X	-	-	-
<i>DN-Q8</i>	X	-	-	-
<i>DN-QD12</i>	X	-	-	-
<i>DN-Q12-1-2</i>	X	-	-	-
<i>DN-Q12-1-2L</i>	X	-	-	-
<i>DN-Q12-1-2D</i>	X	-	-	-
<i>DN-QKBD</i>	X	-	-	-
<i>DN-Q12-2-2</i>	X	-	-	-
<i>DN-Q12-2-2L</i>	X	-	-	-
<i>DN-Q12-2-2D</i>	X	-	-	-
<i>DN-QEMXM1</i>	-	X	X	X
<i>DN-QEMXDV</i>	-	X	X	X
<i>DN-QG12</i>	X	-	-	-
<i>DN-QG10</i>	X	-	-	-
<i>DN-QG8</i>	X	-	-	-
<i>DN-QG12-1-2</i>	X	-	-	-
<i>DN-QG12-2-2</i>	X	-	-	-

Marking Tags

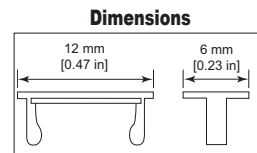
Marking Tags DN-L Series			
Part Number	Marking Sequence	Qty	Price
DN-L50	1-50	500	\$56.00
DN-L100	51-100	500	\$56.00
DN-L150	101-150	500	\$56.00
DN-L200	151-200	500	\$56.00
DN-L250	201-250	500	\$56.00
DN-L300	251-300	500	\$56.00
DN-L350	301-350	500	\$56.00
DN-L400	351-400	500	\$56.00
DN-L450	401-450	500	\$56.00
DN-LB	Blank	500	\$38.00
DN-LS	L1, L2, L3, L, N, GND, +, -, COM,COM*	500	\$56.00



- The marking sequence of 50 tags (i.e. 101-150) is printed 10 times in each package of 500.
- The DN-L tags fit all DINnectors 6mm wide and wider.
- There will be a gap between tags on blocks wider than 6mm.
- Material: Thermoplastic with heat embossed black print.

Marking Tags DN-LA Series			
Part Number	Marking Sequence	Qty	Price
DN-LA100	1-100	500	\$56.00
DN-LA200	101-200	500	\$56.00
DN-LA300	201-300	500	\$56.00
DN-LA400	301-400	500	\$56.00
DN-LAB	Blank Tags	500	\$56.00
DN-LAS	L1, L2, L3, L, N, GND, +, -, COM,COM*	500	\$56.00

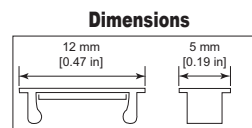

- The marking sequence of 100 tags (i.e. 1-100) is printed five times in each package of 500.
- The DN-LA tags fit all DINnectors 5mm wide and wider. There will be a gap between tags on blocks wider than 5mm.
- Material: Thermoplastic with heat embossed black print.

Marking Tags DN-LAT Series			
Part Number	Marking Sequence	Qty	Price
DN-LAT100-A	1-100	500	\$49.00
DN-LAT200-A	101-200	500	\$49.00
DN-LAT300-A	201-300	500	\$49.00
DN-LAT400-A	301-400	500	\$49.00
DN-LAT500-A	401-500	500	\$49.00
DN-LAT600-A	501-600	500	\$49.00
DN-LATB-A	Blank Tags	500	\$35.50
DN-LATS-A	L1, L2, L3, L, N, +, -, COM,COM*	500	\$49.00

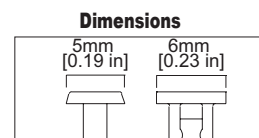

- The marking sequence of 500 tags (i.e. 1-100) is printed five times in each package of 500.
- Material: Thermoplastic with heat embossed black print.

Marking Tags DN-QL Series			
Part Number	Marking Sequence	Qty	Price
DN-QL100	1-100	500	\$42.50
DN-QL200	101-200	500	\$42.50
DN-QL300	201-300	500	\$42.50
DN-QL400	301-400	500	\$42.50
DN-QL500	401-500	500	\$42.50
DN-QLB	Blank Tags	500	\$36.00
DN-QLS	L1, L2, L3, L, N, +, -, COM,COM*	500	\$49.00

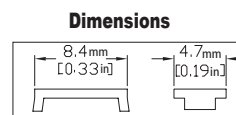

- The marking sequence of 500 (i.e. 1-100) is printed five times in each package of 500.
- Material: Thermoplastic with heat embossed black print.

DINnectors® Accessories

Marking Tags continued

Marking Tags DN-LT Series			
Part Number	Marking Sequence	Qty	Price
DN-LT15	1-5	100	\$10.00
DN-LT60	6-0	100	\$10.00
DN-LT1	1	100	\$10.00
DN-LT2	2	100	\$10.00
DN-LT3	3	100	\$10.00
DN-LT4	4	100	\$10.00
DN-LT5	5	100	\$10.00
DN-LT6	6	100	\$10.00
DN-LT7	7	100	\$10.00
DN-LT8	8	100	\$10.00
DN-LT9	9	100	\$10.00
DN-LT0	0	100	\$10.00
DN-LTBLNK	Unprinted	100	\$10.00
DN-LTA	A	100	\$10.00
DN-LTB	B	100	\$10.00
DN-LTC	C	100	\$10.00
DN-LTD	D	100	\$10.00
DN-LTE	E	100	\$10.00
DN-LTF	F	100	\$10.00
DN-LTG	G	100	\$10.00
DN-LTH	H	100	\$10.00
DN-LTI	I	100	\$10.00
DN-LTJ	J	100	\$10.00
DN-LTK	K	100	\$10.00
DN-LTL	L	100	\$10.00
DN-LTM	M	100	\$10.00
DN-LTN	N	100	\$10.00
-	-	-	-
DN-LTP	P	100	\$10.00
DN-LTQ	Q	100	\$10.00
DN-LTR	R	100	\$10.00
DN-LTS	S	100	\$10.00
DN-LTT	T	100	\$10.00
DN-LTU	U	100	\$10.00
DN-LTV	V	100	\$10.00
DN-LTW	W	100	\$10.00
DN-LTX	X	100	\$10.00
DN-LTY	Y	100	\$10.00
DN-LTZ	Z	100	\$10.00
DN-LTGND	⊕	100	\$10.00
DN-LTPOS	+	100	\$10.00
DN-LTNEG	-	100	\$10.00
DN-LTAC	~	100	\$10.00
DN-LTDC	=	100	\$10.00

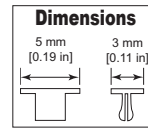

- These marking tags allow the flexibility of creating custom marking sequences on site.
- The DN-M series supports a maximum of three digits (tags), while other DINnectors support up to four digits (tags).
- Material: Thermoplastic with heat embossed black print.

DN-MTA marking tag adapter

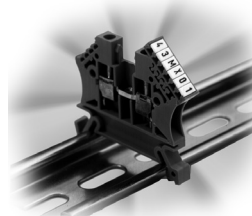

DN-MTA dimensions

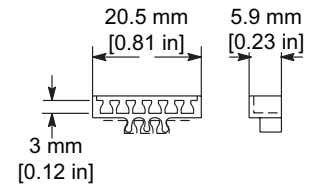

Part Number	Description	Qty	Price
DN-MTA	Marking tag adapter holds up to six DN-LT tags	50	\$14.50

Note: [DN-MTA](#) adapter does not fit [DN-T12-A](#) terminal blocks.

DINnectors® Accessories

Terminal Marking Accessories

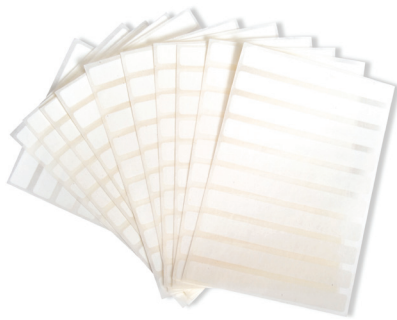

DN-EMLBL1



DN-EMLBL2



DN-EMLBL3

Part Number	Description	For Use With	Qty	Price
DN-EMLBL1	Blank labels	DN-EMPEG1 pin protectors for DN-xEMxx plug-in terminal blocks	100	\$9.25
DN-EMLBL2	Labels printed 1 – 12		100	\$13.00
DN-EMLBL3	Labels printed 13 – 24		100	\$13.00

Marking Pen – for terminal and wire marking tags

- Permanent
- Smudge-proof
- Waterproof
- Weatherproof
- Lightfast (won't fade)
- Dries in seconds (excellent for left-handed users)
- Dry-safe (pen can be left uncapped for days without drying out)
- Low odor ink

Part Number	Description	Qty	Price
DN-MP	Staedtler-Mars marking pen, for use with blank marking tags. Permanent Ink, fine tip.	1	\$4.50



Marking pen

Wire Marking Accessories



DN-WMTAG1 wire tags & DN-WM-x wire tag holders

Part Number	Description	For Use With	Qty	Price
DN-WMTAG1	Wire tag – blank	all DN-WM-x wire tag holders	525	\$60.00
DN-WM-1	Wire tag holder, clear, 12mm length, 0.051–0.118 in diameter; for 22–16 AWG wire	DN-WMTAG1	200	\$12.50
DN-WM-2	Wire tag holder, clear, 12mm length, 0.098–0.196 in diameter; for 16–11 AWG wire		200	\$12.50
DN-WM-3	Wire tag holder, clear, 12mm length, 0.157–0.393 in diameter; for 13–5 AWG wire		100	\$8.25
DN-WM-4	Wire tag holder, clear, 12mm length, 0.314–0.629 in diameter; for 5AWG wire		100	\$7.75