

AC Input Modules

D4-08NA AC Input \$166.00	
Inputs per Module	8
Commons per Module	2 (isolated)
Input Voltage Range	80-265VAC
Peak Voltage	265VAC
AC Frequency	47-63 Hz
ON Voltage Level	>70V
OFF Voltage Level	<30V
Input Impedance	12k Ω
Input Current	8.5 mA @ 100VAC 20mA @ 230VAC
Minimum ON Current	5mA
Maximum OFF Current	2mA
Base Power Required 5V	100mA max
OFF to ON Response	5-30 ms
ON to OFF Response	10-50 ms
Terminal Type (included)	Removable
Status Indicators	265VAC Logic side
Weight	8.4 oz. (240g)

D4-16NA AC Input \$233.00	
Inputs per Module	16
Commons per Module	2 (isolated)
Input Voltage Range	80-132 VAC
Peak Voltage	132VAC
AC Frequency	47-63 Hz
ON Voltage Level	>70V
OFF Voltage Level	<20V
Input Impedance	8k Ω
Input Current	14.5 mA @ 120VAC
Minimum ON Current	7mA
Maximum OFF Current	2mA
Base Power Required 5V	150mA max.
OFF to ON Response	5-30 ms
ON to OFF Response	10-50 ms
Terminal Type (included)	Removable
Status Indicators	Logic side
Weight	9.5 oz. (270g)

See Wiring Solutions for part numbers of ZIPLink cables and connection modules compatible with this I/O module.

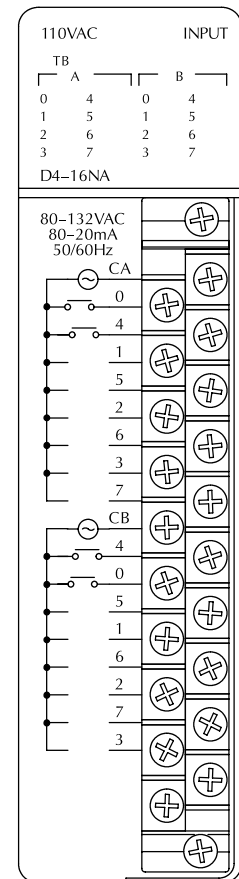
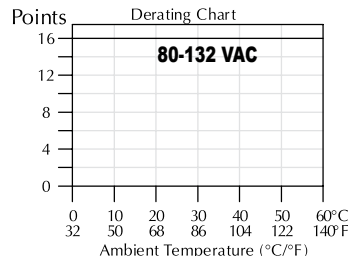
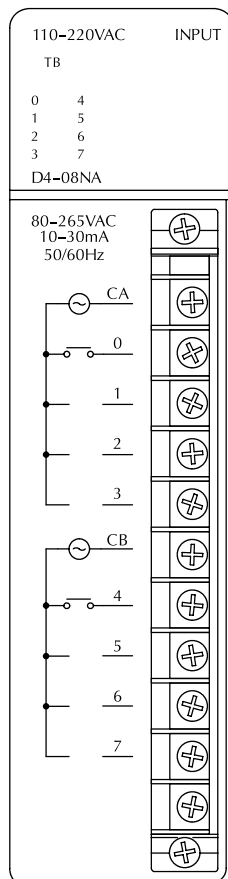
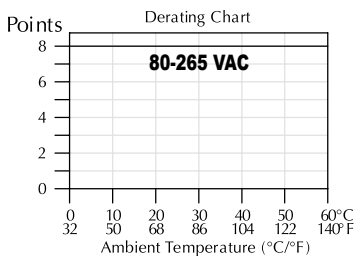

AC/DC Input Module

D4-16NE3 AC/DC Input \$185.00	
Inputs per Module	16 (sink/source)
Commons per Module	2 (isolated)
Input Voltage Range	10.2–26.4 VAC/VDC
Peak Voltage	37.5 VAC/VDC
AC Frequency	47–63 Hz
ON Voltage Level	>9.5 V
OFF Voltage Level	<3.0 V
Input Impedance	3.2 k Ω @ 12V 2.9 k Ω @ 24V
Input Current	3.8 mA @ 12V 8.3 mA @ 24V
Minimum ON Current	4mA
Maximum OFF Current	1.5 mA
Base Power Required 5V	150mA max
OFF to ON Response	5-40 ms
ON to OFF Response	10-50 ms
Terminal Type (included)	Removable
Status Indicators	Logic side
Weight	8.8 oz. (250g)

See Wiring Solutions for part numbers of ZIPLink cables and connection modules compatible with this I/O module.

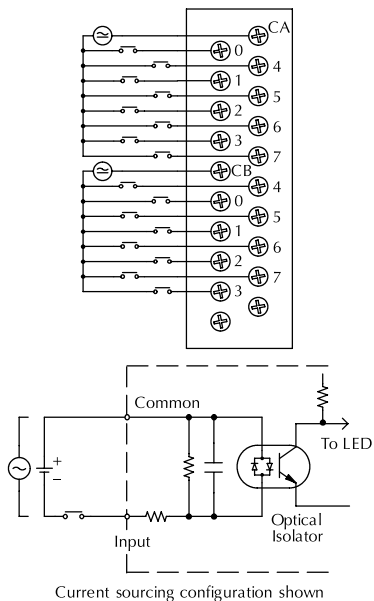
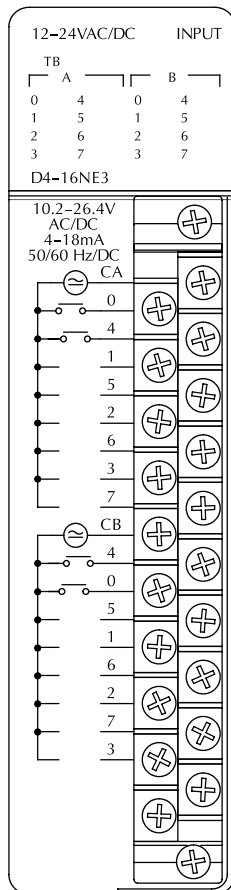
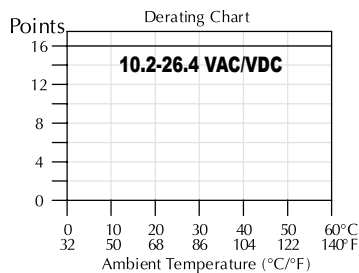

Check the Power Budget

Verify your power budget requirements

Your I/O configuration choice can be affected by the power requirements of the I/O modules you choose. When determining the types and quantity of I/O modules you will be using, it is important to remember there is a limited amount of power available from the power supply.

The chart on the opposite page indicates the power supplied and used by each DL405 device. The adjacent chart shows an example of how to calculate the power used by your particular system. These two charts should make it easy for you to determine if the devices you have chosen fit within the power budget of your system configuration.

If the I/O you have chosen exceeds the maximum power available from the power supply, you can resolve the problem by shifting some of the modules to an expansion base or remote I/O base (if you are using remote I/O).

Warning: It is extremely important to calculate the power budget correctly. If you exceed the power budget, the system may operate in an unpredictable manner which may result in a risk of personal injury or equipment damage.

Use ZIPLinks to reduce power requirements

If your application requires a lot of relay outputs, consider using the Ziplink AC or DC relay output modules. These modules can switch high current (10A) loads without putting a load on your base power budget. Refer to Wiring System for DL405 PLCs later in this section for more information.

This logo is placed next to I/O modules that are supported by the Ziplink connection systems.



See the I/O module specifications at the end of this section.

Calculating your power usage

The following example shows how to calculate the power budget for the DL405 system. The example is constructed around a single 8-slot base using the devices shown. It is recommended you construct a similar table for each base in your system.

A				
	Base Number 0	Device Type	5 VDC (mA)	External 24 VDC Power (mA)
B	CURRENT SUPPLIED			
	CPU/Expansion Unit /Remote Server	D4-454 CPU	3700	400
C	CURRENT REQUIRED			
	SLOT 0	D4-16ND2	+150	+0
	SLOT 1	D4-16ND2	+150	+0
	SLOT 2	F4-04DA-2	+90	+90
	SLOT 3	D4-08NA	+100	+0
	SLOT 4	D4-08NA	+100	+0
	SLOT 5	D4-16TD2	+100	+0
	SLOT 6	D4-16TD2	+100	+0
	SLOT 7	D4-16TR	+1000	+0
D	OTHER			
	BASE	D4-08B-1	+80	+0
	Handheld Programmer	D4-HPP-1	+320	+0
E	Maximum Current Required		2190	90
F	Remaining Current Available		3700-2190=1510	400-90=310
1. Using a chart similar to the one above, fill in column 2. 2. Using the tables on the opposite page, enter the current supplied and used by each device (columns 3 and 4). Pay special attention to the current supplied by the CPU, Expansion Unit, and Remote Server since they differ. Devices which fall into the "Other" category (Row D) are devices such as the Base and the Handheld programmer, which also have power requirements, but do not plug directly into the base. 3. Add the current used by the system devices (columns 3 and 4) starting with Slot 0 and put the total in the row labeled "maximum current required" (Row E). 4. Subtract the row labeled "Maximum current required" (Row E), from the row labeled "Current Supplied" (Row B). Place the difference in the row labeled "Remaining Current Available" (Row F). 5. If "Maximum Current Required" is greater than "Current Supplied" in either column 3 or 4, the power budget will be exceeded. It will be unsafe to use this configuration and you will need to restructure your I/O configuration. Note the auxiliary 24VDC power supply does not need to supply all the external power. If you need more than the 400mA supplied, you can add an external 24VDC power supply. This will help keep you within your power budget for external power.				

DL405 CPU power supply specifications and power requirements

Specification	AC Powered Units	24 VDC Powered Units
Part Numbers	D4-454, D4-EX (expansion base unit), D4-RS (remote Server unit)	D4-454DC-1, D4-EXDC (expansion base unit)
Voltage Withstand (dielectric)	1 minute @ 1,500 VAC between primary, secondary, field ground, and run relay	
Insulation Resistance	> 10MΩ at 500VDC	
Input Voltage Range	85-132 VAC (110V range) 170-264 VAC (220V range)	20-28 VDC (24VDC) with less than 10% ripple
Maximum Inrush Current	20A	20A
Maximum Power	50VA	38W

Power Requirements

Power Supplied					
CPUs/RemoteUnits/ Expansion Units	5 VDC Current Supplied in mA	24V Aux Power Supplied in mA	CPUs/Remote Units/ Expansion Units	5V Current Supplied in mA	24V Aux Power Supplied in mA
D4-454 CPU D4-454DC-1	3100 3100	400 NONE	D4-EX D4-EXDC D4-RS H4-EBC	4000 4000 3700 3470	400 NONE 400 400
Power Consumed					
Power-consuming Device	5V Current Consumed	External 24VDC Current Required	Power-consuming Device	5V Current Consumed	External 24VDC Current Required
I/O Bases			Analog Modules (continued)		
D4-04B-1	80	NONE	F4-16AD-1	75	100
D4-06B-1	80	NONE	F4-16AD-2	75	100
D4-08B-1	80	NONE	F4-08DA-1	70	75+20 per circuit
DC Input Modules			F4-08DA-2	90	90
D4-16ND2	150	NONE	F4-04DAS-1	60	60 per circuit
D4-16ND2F	150	NONE	F4-08DA-1	90	100+20 per circuit
D4-32ND3-1	150	NONE	F4-08DA-2	80	150
D4-64ND2	300 max.	NONE	F4-16DA-1	90	100+20 per circuit
AC Input Modules			F4-16DA-2	80	25 max.
D4-08NA	100	NONE	F4-08RTD	80	NONE
D4-16NA	150	NONE	F4-08THM-J(-n)	120	50
AC/DC Input Modules			F4-08THM	110	60
D4-16NE3	150	NONE	Remote I/O		
DC Output Modules			H4-ERM100	320(300)	NONE
D4-16TD1	200	125	H4-ERM-F	450	NONE
D4-16TD2	400	NONE	D4-RM	300	NONE
D4-32TD1	250	140	Communications and Networking		
D4-32TD2	350	120 (4A max including loads)	H4-ECOM100	300	NONE
D4-64TD1	800	NONE	D4-DCM	500	NONE
AC Output Modules			F4-MAS-MB	235	NONE
D4-08TA	250	NONE	CoProcessors		
D4-16TA	450	NONE	F4-CP128-1	305	NONE
Relay Output Modules			Specialty Modules		
D4-08TR	550	NONE	H4-CTRIO	400	NONE
F4-08TRS-1	575	NONE	D4-16SIM	150	NONE
F4-08TRS-2	575	NONE	F4-4LTC	280	75
D4-16TR	1000	NONE	Programming		
Analog Modules			D4-HPP-1 (Handheld Prog.)	320	NONE
F4-04AD	150	100	Operator Interface		
F4-04ADS	370	120	C-more Micro-Graphic	210	NONE
F4-08AD	75	90			



Wiring Solutions

Wiring Solutions using the ZIPLink Wiring System

ZIPLinks eliminate the normally tedious process of wiring between devices by utilizing prewired cables and DIN rail mount connector modules. It's as simple as plugging in a cable connector at either end or terminating wires at only one end. Prewired cables keep installation clean and efficient, using half the space at a fraction of the cost of standard terminal blocks. There are several wiring solutions available when using the **ZIPLink** System ranging from PLC I/O-to-**ZIPLink** Connector

Modules that are ready for field termination, options for connecting to third party devices, GS, DuraPulse and SureServo Drives, and specialty relay, transorb and communications modules. Pre-printed I/O-specific adhesive label strips for quick marking of **ZIPLink** modules are provided with **ZIPLink** cables. See the following solutions to help determine the best **ZIPLink** system for your application.

Solution 1: DirectLOGIC I/O Modules to ZIPLink Connector Modules

When looking for quick and easy I/O-to-field termination, a **ZIPLink** connector module used in conjunction with a prewired **ZIPLink** cable, consisting of an I/O terminal block at one end and a multi-pin connector at the other end, is the best solution.

Using the PLC I/O Modules to **ZIPLink** Connector Modules selector tables located in this section,

1. Locate your I/O module/PLC.
2. Select a **ZIPLink** Module.
3. Select a corresponding **ZIPLink** Cable.



Solution 2: DirectLOGIC I/O Modules to 3rd Party Devices

When wanting to connect I/O to another device within close proximity of the I/O modules, no extra terminal blocks are necessary when using the **ZIPLink** Pigtail Cables. **ZIPLink** Pigtail Cables are prewired to an I/O terminal block with color-coded pigtail with soldered-tip wires on the other end.

Using the I/O Modules to 3rd Party Devices selector tables located in this section,

1. Locate your PLC I/O module.
2. Select a **ZIPLink** Pigtail Cable that is compatible with your 3rd party device.



Solution 3: GS Series and DuraPulse Drives Communication Cables

Need to communicate via Modbus RTU to a drive or a network of drives?

ZIPLink cables are available in a wide range of configurations for connecting to PLCs and SureServo, SureStep, Stellar Soft Starter and AC drives. Add a **ZIPLink** communications module to quickly and easily set up a multi-device network.

Using the Drives Communication selector tables located in this section,

1. Locate your Drive and type of communications.
2. Select a **ZIPLink** cable and other associated hardware.





Wiring Solutions

Solution 4: Serial Communications Cables

ZIPLink offers communications cables for use with DirectLOGIC, CLICK, and Productivity3000 CPUs, that can also be used with other communications devices. Connections include a 6-pin RJ12 or 9-pin, 15-pin and 25-pin D-sub connectors which can be used in conjunction with the RJ12 or D-Sub Feedthrough modules.

Using the Serial Communications Cables selector table located in this section,

1. Locate your connector type
2. Select a cable.



Solution 5: Specialty ZIPLink Modules

For additional application solutions, **ZIPLink** modules are available in a variety of configurations including stand-alone relays, 24VDC and 120VAC transorb modules, D-sub, RJ12 and RJ45 feedthrough modules, communication port adapter and distribution modules, and SureServo 50-pin I/O interface connection.

Using the **ZIPLink** Specialty Modules selector table located in this section,

1. Locate the type of application.
2. Select a **ZIPLink** module.



Solution 6: ZIPLink Connector Modules to 3rd Party Devices

If you need a way to connect your device to terminal blocks without all that wiring time, then our pigtail cables with color-coded soldered-tip wires are a good solution. Used in conjunction with any compatible **ZIPLink** Connector Modules, a pigtail cable keeps wiring clean and easy and reduces troubleshooting time.

Using the Universal Connector Modules and Pigtail Cables table located in this section,

1. Select module type.
2. Select the number of pins.
3. Select cable.





PLC I/O Modules to ZIPLink Connector Modules - DL405

DL405 PLC Input Module ZIPLink Selector				
PLC	ZIPLink			
Input Module	# of Terms	Component	Module Part No.	Cable Part No.
D4-16ND2	20	See Note 3		
D4-16ND2F				
D4-32ND3-1²	40	Feedthrough	ZL-RTB40 (-1)	straight conn: ZL-D24-CBL40
		Sensor	ZL-LTB32-24-1	ZL-D24-CBL40-1
		Feedthrough	ZL-RTB40 (-1)	ZL-D24-CBL40-2
D4-64ND2^{1,2}		Sensor	ZL-LTB32-24-1	45 deg conn: ZL-D24-CBL40-X ZL-D24-CBL40-1X ZL-D24-CBL40-2X
D4-08NA	11	See Note 3		
D4-16NA	20			
D4-16NE3				

DL405 PLC Output Module ZIPLink Selector				
PLC	ZIPLink			
Output Module	# of Terms	Component	Module Part No.	Cable Part No.
D4-16TD1	20	See Note 3		
D4-16TD2				
D4-32TD1²	40	Feedthrough	Feedthrough ZL-RTB40 (-1) Fused ZL-RFU40⁴	straight conn: ZL-D24-CBL40
		Fuse		ZL-D24-CBL40-1
D4-32TD2²		Feedthrough		ZL-D24-CBL40-2
		Fuse		
D4-64TD1^{1,2}		Feedthrough		45 deg conn: ZL-D24-CBL40-X ZL-D24-CBL40-1X ZL-D24-CBL40-2X
		Fuse		
D4-08TA	11	See Note 3		
D4-16TA	20			
D4-08TR	11			
F4-08TRS-1	20			
F4-08TRS-2				
D4-16TR				

DL405 PLC Analog Module ZIPLink Selector				
PLC	ZIPLink			
Analog Module	# of Terms	Component	Module	Cable
F4-04AD	20	See Note 3		
F4-04ADS				
F4-08AD				
F4-16AD-1				
F4-16AD-2				
F4-04DA-1				
F4-04DA-2				
F4-08DA-1				
F4-16DA-1				
F4-08DA-2				
F4-16DA-2				
F4-04DAS-1				
F4-08THM				
F4-08THM-n	Matched Only			
F4-08RTD				

Tables Footnotes:

- The [D4-64ND2](#) and [D4-64TD1](#) modules have two 32-point connectors and require two ZIPLink cables and two ZIPLink connector modules.
- To make a custom cable for the 32 or 64-point modules, use: Ribbon-style Connector [ZL-D24-CON-R](#), Solder-style 180° connector [ZL-D24-CON](#) or Solder-style 45° connector [ZL-D24-CON-X](#)
- These modules are not supported by the ZIPLink wiring system.
- Note: Fuses (5 x 20 mm) are not included. See Edison Electronic Fuse section for (5 x 20 mm) fuse. S500 and GMA electronic circuit protection for fast-acting maximum protection. S506 and GMC electronic circuit protection for time-delay performance. Ideal for inductive circuits. To ensure proper operation, do not exceed the voltage and current rating of ZIPLink module. [ZL-RFU20](#) = 2A per circuit; [ZL-RFU40](#) = 400 mA per circuit.



Note: ZIPLink Connector Module specifications follow the Compatibility Matrix tables in the ZIPLink section.