

DC Output Modules

D2-16TD1-2 DC Output \$152.00	
Outputs per Module	16 (current sinking)
Commons per Module	1 (2 I/O terminal points)
Output Type	NPN open collector
External DC required	24VDC \pm 4V @ 80mA max
Operating Voltage	10.2-26.4 VDC
Peak Voltage	30VDC
ON Voltage Drop	0.5 VDC maximum
AC Frequency	N/A
Minimum Load Current	0.2 mA
Max Load Current	0.1 A/point 1.6 A/common
Max Leakage Current	0.1 mA @ 30VDC
Max Inrush Current	150mA for 10ms
Base Power Required 5VDC	200mA
OFF to ON Response	0.5 ms
ON to OFF Response	0.5 ms
Terminal Type (included)	Removable; D2-16IOCON
Status Indicator	Logic side
Weight	2.3 oz. (65g)
Fuses	None

D2-16TD2-2 DC Output \$152.00	
Outputs per Module	16 (current sourcing)
Commons per Module	2
Output Type	NPN open collector
Operating Voltage	10.2-26.4 VDC
Peak Voltage	30VDC
ON Voltage Drop	1.0 VDC maximum
AC Frequency	N/A
Minimum Load Current	0.2 mA
Max Load Current	0.1 A/point 1.6 A/module
Max Leakage Current	0.1 mA @ 30VDC
Max Inrush Current	150mA for 10ms
Base Power Required 5VDC	200mA
OFF to ON Response	0.5 ms
ON to OFF Response	0.5 ms
Terminal Type (included)	Removable; D2-16IOCON
Status Indicator	Logic side
Weight	2.8 oz. (80g)
Fuses	None

See Wiring Solutions for part numbers of **ZIPLink** cables and connection modules compatible with this I/O module.



See Wiring Solutions for part numbers of **ZIPLink** cables and connection modules compatible with this I/O module.

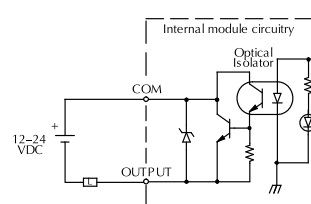
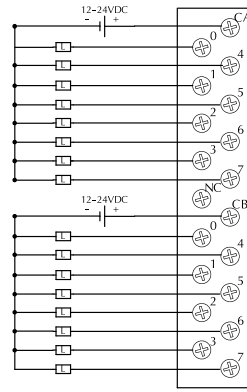
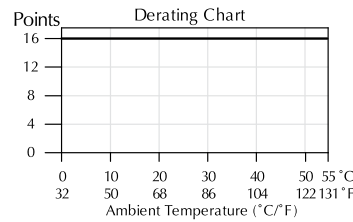
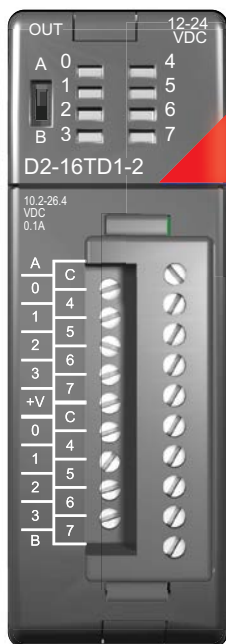
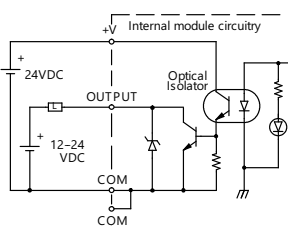
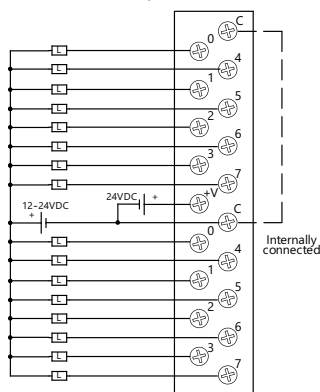
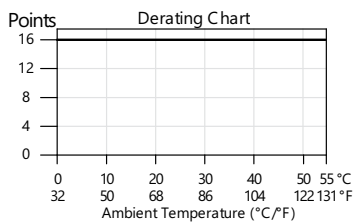

ZIPLINK™ Wiring Solutions

AUTOMATIONDIRECT

Wiring Solutions using the ZIPLink Wiring System

ZIPLinks eliminate the normally tedious process of wiring between devices by utilizing prewired cables and DIN rail mount connector modules. It's as simple as plugging in a cable connector at either end or terminating wires at only one end.

Prewired cables keep

installation clean and efficient, using half the space at a fraction of the cost of standard terminal blocks. There are several wiring

solutions available when using the ZIPLink System ranging from PLC I/O-to-ZIPLink Connector Modules that are ready for field

termination, options for connecting to third party devices, GS, DuraPulse and SureServo Drives, as well as special relay, transorb and communications modules. Pre-printed I/O-specific adhesive label strips for quick marking of ZIPLink modules are provided with ZIPLink cables. See the following solutions to help determine the best ZIPLink system for your application.

Solution 1: Do-more, DirectLOGIC, CLICK and Productivity Series I/O Modules to ZIPLink Connector Modules

When looking for quick and easy I/O-to-field termination, a ZIPLink connector module used in conjunction with a prewired ZIPLink cable, consisting of an I/O terminal block at one end and a multi-pin connector at the other end, is the best solution.



Using the PLC I/O Modules to ZIPLink Connector Modules selector tables located in this section,

1. Locate your I/O module/PLC
2. Select a ZIPLink Module
3. Select a corresponding ZIPLink Cable.

Solution 2: Do-more, DirectLOGIC, CLICK and Productivity Series I/O Modules to 3rd Party Devices

When wanting to connect I/O to another device within proximity of the I/O modules, no extra terminal blocks are necessary when using the ZIPLink Pigtail Cables. ZIPLink Pigtail Cables are prewired to an I/O terminal block with color-coded pigtail with soldered-tip wires on the other end.



Using the I/O Modules to 3rd Party Devices selector tables located in this section,

1. Locate your PLC I/O module
2. Select a ZIPLink Pigtail Cable that is compatible with your 3rd party device.

Solution 3: GS Series and DuraPulse Drives Communication Cables

Need to communicate via Modbus RTU to a drive or a network of drives?

ZIPLink cables are available in a wide range of configurations for connecting to PLCs and SureServo, SureStep, Stellar Soft Starter and AC drives. Add a ZIPLink communications module to quickly and easily set up a multi-device network.

Using the Drives Communication selector tables located in this section,

1. Locate your Drive and type of communications
2. Select a ZIPLink cable and other associated hardware.



ZIPLINK™ Wiring Solutions

AUTOMATIONDIRECT

Solution 4: Serial Communications Cables

ZIPLink offers communications cables for use with **DirectLOGIC**, CLICK, and Productivity CPUs, that can also be used with other communications devices. Connections include a 6-pin RJ12 or 9-pin, 15-pin and 25-pin D-sub connectors which can be used in conjunction with the RJ12 or D-Sub feedthrough modules.

Using the Serial Communications Cables selector table located in this section,

1. Locate your connector type
2. Select a cable.



Solution 5: Specialty ZIPLink Modules

For additional application solutions, **ZIPLink** modules are available in a variety of configurations including stand-alone relays, 24VDC and 120VAC transorb modules, D-sub, RJ12 and RJ45 feedthrough modules, communication port adapter and distribution modules, and SureServo 50-pin I/O interface connection.

Using the **ZIPLink** Specialty Modules selector table located in this section,

1. Locate the type of application
2. Select a **ZIPLink** module.



Solution 6: ZIPLink Connector Modules to 3rd Party Devices

If you need a way to connect your device to terminal blocks without all that wiring time, then our pigtail cables with color-coded soldered-tip wires are a good solution. Used in conjunction with any compatible **ZIPLink** Connector Modules, a pigtail cable keeps wiring clean and easy and reduces troubleshooting time.

Using the Universal Connector Modules and Pigtail Cables table located in this section,

1. Select module type
2. Select the number of pins
3. Select cable.





PLC I/O Modules to ZIPLink Connector Modules – Do-more!/DL205

Do-more / DL205 PLC Input Module ZIPLink Selector				
PLC	ZIPLink			
Input Module	# of Terms	Component	Module Part No.	Cable Part No. †
D2-08ND3	10	Feedthrough	ZL-RTB20 (-1)	ZL-D2-CBL10 *
D2-16ND3-2	19	Feedthrough		ZL-D2-CBL19
		Sensor	ZL-LTB16-24-1	ZL-D2-CBL19-1 ZL-D2-CBL19-2
D2-32ND3 1	40	Feedthrough	ZL-RTB40 (-1)	180 deg conn: ZL-D24-CBL40
		Sensor	ZL-LTB32-24-1	ZL-D24-CBL40-1 ZL-D24-CBL40-2
D2-32ND3-2 1	40	Feedthrough	ZL-RTB40(-1)	45 deg conn: ZL-D24-CBL40-X ZL-D24-CBL40-1X ZL-D24-CBL40-2X
		Sensor	ZL-LTB32-24-1	
D2-08NA-1	10	Feedthrough	ZL-RTB20 (-1)	ZL-D2-CBL10
D2-08NA-2	10			ZL-D2-CBL10-1
D2-16NA	19			ZL-D2-CBL10-2
				ZL-D2-CBL19 *

† X in the part number represents a 45° angle.

Do-more/ DL205 PLC Output Module ZIPLink Selector				
PLC	ZIPLink			
Output Module	# of Terms	Component	Module Part No.	Cable Part No. †
D2-04TD1 2	10	Feedthrough	ZL-RTB20 (-1)	ZL-D2-CBL10
D2-08TD1				ZL-D2-CBL10-1
D2-08TD2				ZL-D2-CBL10-2
D2-16TD1-2		Feedthrough	ZL-RTB20 (-1)	
		Fuse		
D2-16TD2-2	19	Feedthrough	ZL-RTB20 (-1)	ZL-D2-CBL19 ZL-D2-CBL19-1 ZL-D2-CBL19-2
		Fuse	ZL-RFU20 4	
		Relay	ZL-RRL16-24-2 ZL-RRL16W-24-2 ZL-RRL16F-24-2 ZL-RRL16HDF-24-2	
F2-16TD1P		Feedthrough	ZL-RTB20 (-1)	
F2-16TD2P				
D2-32TD1 1	40	Feedthrough	ZL-RTB40 (-1)	180 deg conn: ZL-D24-CBL40 ZL-D24-CBL40-1 ZL-D24-CBL40-2
		Fuse	ZL-RFU40 4	
D2-32TD2 1		Feedthrough	ZL-RTB40 (-1)	45 deg conn: ZL-D24-CBL40-X ZL-D24-CBL40-1X ZL-D24-CBL40-2X
		Fuse	ZL-RFU40 4	
D2-08TA	10	Feedthrough	ZL-RTB20 (-1)	ZL-D2-CBL10
F2-08TA				ZL-D2-CBL10-1 ZL-D2-CBL10-2
D2-12TA	19	Feedthrough	ZL-RTB20 (-1)	ZL-D2-CBL19
		Fuse		ZL-RFU20 4
D2-04TRS 2	10	Feedthrough	ZL-RTB20 (-1)	ZL-D2-CBL10
D2-08TR				ZL-D2-CBL10-1 ZL-D2-CBL10-2
F2-08TRS 2	19	Feedthrough	ZL-RTB20 (-1)	ZL-D2-CBL19 *
F2-08TR 3	10			ZL-D2-CBL10 *
D2-12TR	19	Feedthrough	ZL-RTB20 (-1)	ZL-D2-CBL19
		Fuse		ZL-RFU20 4

† X in the part number represents a 45° angle plug

* Select the cable length by replacing the * with: Blank = 0.5 m, -1 = 1.0 m, or -2 = 2.0 m.

1 To make a custom cable for the 32-point modules, use: Solder-style 180° connector ZL-D24-CON or Solder-style 45° connector ZL-D24-CON-X

2 Caution: The D2-04TD1, D2-04TRS, and F2-08TRS outputs are derated not to exceed module specs 2A per point and 2A per common when used with the ZIPLink wiring system.

3 The F2-08TR outputs are derated not to exceed 2A per point and 4A per common when used with the ZIPLink wiring system.

4 Fuses (5 x 20 mm) are not included. See Edison Electronic Fuse section for (5 x 20 mm) fuse. S500 and GMA electronic circuit protection for fast-acting maximum protection. S506 and GMC electronic circuit protection for time-delay performance. Ideal for inductive circuits.

To ensure proper operation, do not exceed the voltage and current rating of ZIPLink module. ZL-RFU20 = 2A per circuit; ZL-RFU40 = 400mA per circuit.

Do-more/DL205 PLC Combo In/Out Module ZIPLink Selector				
PLC	ZIPLink			
Combo Module	# of Terms	Component	Module Part No.	Cable Part No.
D2-08CDR	10	Feedthrough	ZL-RTB20 (-1)	ZL-D2-CBL10 *

Do-more/DL205 PLC Analog Module ZIPLink Selector				
PLC	ZIPLink			
Analog Module	# of Terms	Component	Module	Cable
F2-04AD-1	10	Feedthrough	ZL-RTB20 (-1)	ZL-D2-CBL10 ZL-D2-CBL10-1 ZL-D2-CBL10-2
F2-08AD-1				
F2-04AD-2				
F2-08AD-2				
F2-02DA-1				ZL-D2-CBL19 ZL-D2-CBL19-1 ZL-D2-CBL19-2
F2-02DAS-1				
F2-08DA-1				
F2-02DA-2				
F2-02DAS-2				ZL-D2-CBL10 ZL-D2-CBL10-1 ZL-D2-CBL10-2
F2-08DA-2				
F2-4AD2DA				
F2-8AD4DA-1				
F2-8AD4DA-2				ZL-D2-CBL19 ZL-D2-CBL19-1 ZL-D2-CBL19-2
F2-04RTD	Matched Only	These modules are not supported by the ZIPLink wiring system		
F2-04THM				



Note: ZIPLink Connector Module specifications follow the Compatibility Matrix tables. ZIPLink Cables specifications are at the end of this ZIPLink section.



Dimensions and Installation

Understanding the installation requirements for your DL205 system will help ensure that the DL205 products operate within their environmental and electrical limits.

Plan for safety

This catalog should never be used as a replacement for the user manual. The user manual, D2-USER-M (downloadable online), contains important safety information that must be followed. The system installation should comply with all appropriate electrical codes and standards.

Environmental specifications

The Environmental Specifications table at the right lists specifications that apply globally to the DL205 system (CPUs, bases, and I/O modules). Be sure that the DL205 system is operated within these environmental specifications.

Base dimensions and mounting

Use the diagrams below to make sure the DL205 system can be installed in your application. To ensure proper airflow for cooling purposes, DL205 bases must be mounted horizontally. It is important to check these dimensions against the conditions required for your application. For example, it is recommended that approximately 3" of space is left in front PLC surface for ease of access and cable clearances. Also, check the installation guidelines for recommended cabinet clearances.

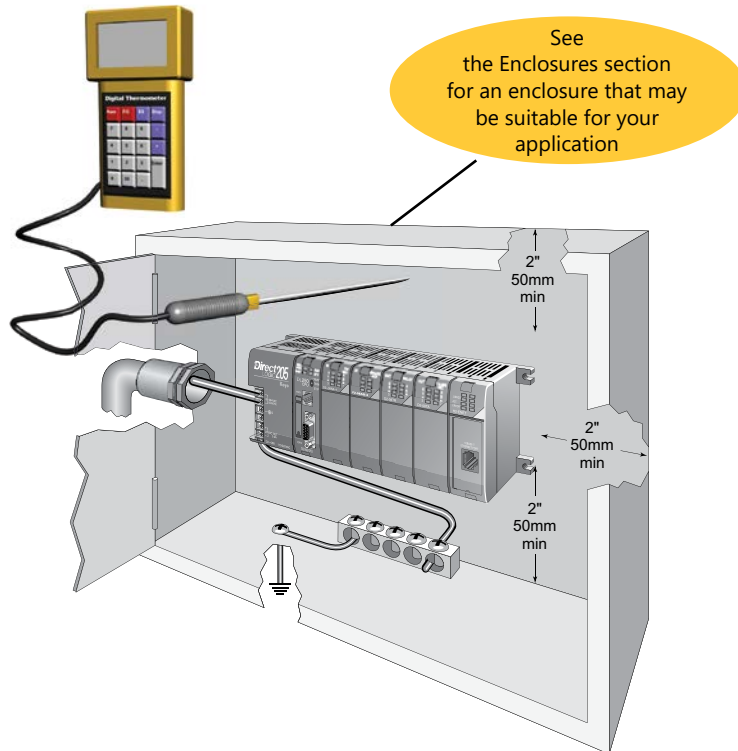

Environmental Specification	Rating
Storage Temperature	-4°F to 158°F (-20°C to 70°C)
Ambient Operating Temperature	32°F to 131°F (0°C to 55°C)
Ambient Humidity	30% to 95% relative humidity (non-condensing)
Vibration Resistance	MIL STD 810C, Method 514.2
Shock Resistance	MIL STD 810C, Method 516.2
Noise Immunity	NEMA (ICS3-304)
Atmosphere	No corrosive gases

Base	A	B	C	D
D2-03B-1, D2-03BDC1-1	6.77" 172mm	6.41" 163mm	5.8" 148mm	7.24" 184mm
D2-04B-1, D2-04BDC1-1	7.99" 203mm	7.63" 194mm	7.04" 179mm	8.46" 215mm
D2-06B-1, D2-06BDC1-1, D2-06BDC2-1	10.43" 265mm	10.07" 256mm	9.48" 241mm	10.90" 277mm
D2-09B-1, D2-09BDC1-1, D2-09BDC2-1	14.09" 358mm	13.74" 349mm	13.14" 334mm	14.56" 370mm

