

# DL06 I/O Specifications

**D0-06DA**      **\$437.00**

Wiring diagram and specifications

D0-06DA Specifications		
<b>AC Power Supply Specifications</b>	<b>Voltage Range</b>	100-240 VAC/ 50-60 Hz, 40VA maximum
	<b>Number of Input Pts.</b>	20 (sink/source)
<b>DC Input Specifications</b>	<b>Number of Commons</b>	5 (isolated)
	<b>Input Voltage Range</b>	10.8-26.4 VDC
	<b>Input Impedance</b>	(X0-X3) 1.8K @ 12-24 VDC (X4-X23) 2.8K @ 12-24 VDC
	<b>On Current/Voltage Level</b>	>5mA/10VDC
	<b>OFF Current/Voltage Level</b>	<0.5 mA/<2VDC
	<b>Response Time</b>	X0-X3    X4-X23
	<b>OFF to ON Response</b>	<70µs    2-8ms
	<b>ON to OFF Response</b>	<70µs    2-8ms
	<b>Fuses</b>	None
	<b>AC Output Specifications</b>	<b>Number of Output Points</b>
<b>Number of Commons</b>		4 (isolated)
<b>Operating Voltage Range</b>		17-240 VAC 47-63 Hz
<b>Peak Voltage</b>		264VAC
<b>ON Voltage Drop</b>		1.5 VAC>50mA 4.0 VAC<50mA
<b>Maximum Current</b>		0.5 A / point; 1.5 A /common
<b>Maximum Leakage Current</b>		4mA @ 264VAC, 60Hz
<b>Maximum Inrush Current</b>		10A for 10ms
<b>Minimum Load</b>		10mA
<b>OFF to ON Response</b>		1ms
<b>ON to OFF Response</b>		1ms + 1/2 cycle
<b>Fuses</b>		None (external recommended)

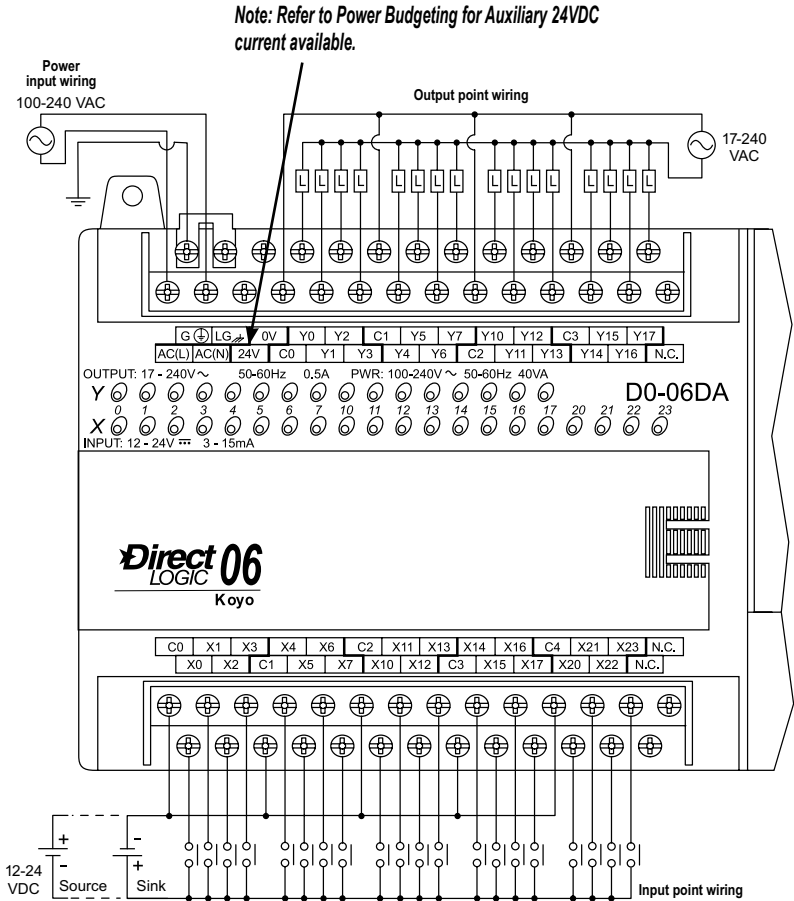

Note: Refer to Power Budgeting for Auxiliary 24VDC current available.

Equivalent input circuit, High-speed inputs (X0-X3)

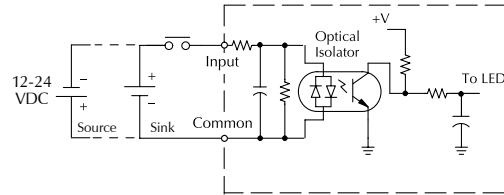

Equivalent input circuit, Standard inputs (X4-X23)

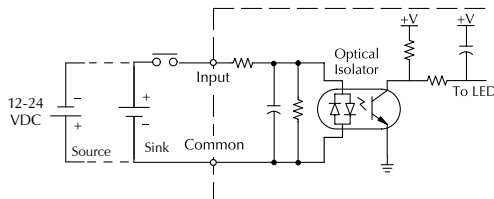

Equivalent output circuit

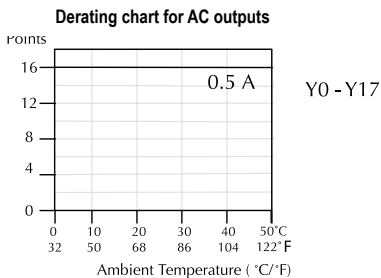
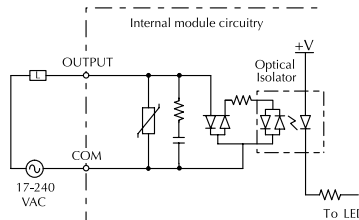

# Features at a Glance

The DL05 and DL06 micro PLCs are complete self-contained systems. The CPU, power supply, and I/O are all included inside the same housing. Option modules are available to expand the capability of each PLC family for more demanding applications. The standard features of these PLCs are extraordinary and compare favorably with larger and more expensive PLCs.

The specification tables to the right are meant for quick reference only. Detailed specifications and wiring information for each model of the DL05 and DL06 PLCs can be found in those specific sections.

## Program capacity

Most boolean ladder instructions require a single word of program memory. Other instructions, such as timers, counters, etc., require two or more words. Data is stored in V-memory in 16-bit registers.

### Performance

The performance characteristics shown in the tables represent the amount of time required to read the inputs, solve the Relay Ladder Logic program and update the outputs.

### Instructions

A complete list of instructions is available at the end of this section.

### Communications

The DL05 and DL06 offer powerful communication features normally found only on more expensive PLCs.

### Special features

The DC input and DC output PLCs offer high-speed counting or pulse output. Option module slots allow for discrete I/O expansion, analog I/O, or additional communication options.

DL05 CPU Specifications	
<b>System capacity</b>	
Total memory available (words).....	6K
Ladder memory (words).....	2048
V-memory (words).....	4096
User V-memory.....	3968
Non-volatile user V-memory.....	128
Battery backup.....	Yes1
Total built-in I/O.....	14
Inputs.....	8
Outputs.....	6
I/O expansion.....	Yes1
<b>Performance</b>	
Contact execution (Boolean).....	0.7 µs
Typical scan (1K Boolean) <sup>2</sup> .....	1.5-3 ms.
<b>Instructions and diagnostics</b>	
RLL ladder style.....	Yes
RLLPLUS/flowchart style (Stages).....	Yes/256
Run-time editing.....	Yes
Supports Overrides.....	Yes
Scan.....	Variable/fixed
<b>Number of Instructions</b> .....	133
<b>Types of Instructions:</b>	
Control relays.....	512
Timers.....	128
Counters.....	128
Immediate I/O.....	Yes
Subroutines.....	Yes
For/next loops.....	Yes
Timed interrupt.....	Yes
Integer math.....	Yes
Floating-point math.....	No
PID.....	Yes
Drum sequencers.....	Yes
Bit of word.....	Yes
ASCII print.....	Yes
Real-time clock/calendar.....	Yes <sup>1</sup>
Internal diagnostics.....	Yes
Password security.....	Yes
System and user error log.....	No
<b>Communications</b>	
Built-in portsTwo RS-232C	
<b>Protocols supported:</b>	
K-sequence (proprietary protocol).....	Yes
DirectNet Client/Server.....	Yes
Modbus RTU Client/Server.....	Yes
ASCII out.....	Yes
Baud rate	
Port 1.....	9,600 baud (fixed)
Port 2.....	selectable 300-38,400 baud (default 9,600)
<b>Specialty Features</b>	
Filtered inputs.....	Yes <sup>3</sup>
Interrupt input.....	Yes <sup>3</sup>
High speed counter.....	Yes, 5kHz <sup>2</sup>
Pulse output.....	Yes, 7kHz <sup>2</sup>
Pulse catch input.....	Yes <sup>3</sup>
<ol style="list-style-type: none"> <li>1- These features are available with use of certain option modules. Option module specifications are located later in this section.</li> <li>2- Our 1K program includes contacts, coils, and scan overhead. If you compare our products to others, make sure you include their scan overhead.</li> <li>3- Input features only available on units with DC inputs and output features only available on units with DC outputs.</li> </ol>	

DL06 CPU Specifications	
<b>System capacity</b>	
Total memory available (words).....	14.8K
Ladder memory (words).....	7680
V-memory (words).....	7616
User V-memory.....	7488
Non-volatile user V-memory.....	128
Built-in battery backup (D2-BAT-1).....	Yes
Total I/O.....	36
Inputs.....	20
Outputs.....	16
I/O expansion.....	Yes <sup>1</sup>
<b>Performance</b>	
Contact execution (Boolean).....	0.6 µs
Typical scan (1K Boolean) <sup>2</sup> .....	1-2 ms.
<b>Instructions and diagnostics</b>	
RLL ladder style.....	Yes
RLLPLUS/flowchart style (Stages).....	Yes/1024
Run-time editing.....	Yes
Supports Overrides.....	Yes
Scan.....	Variable/fixed
<b>Number of Instructions</b> .....	229
<b>Types of Instructions:</b>	
Control relays.....	1024
Timers.....	256
Counters.....	128
Immediate I/O.....	Yes
Subroutines.....	Yes
For/next loops.....	Yes
Table functions.....	Yes
Timed interrupt.....	Yes
Integer math.....	Yes
Trigonometric functions.....	Yes
Floating-point math.....	Yes
PID.....	Yes
Drum sequencers.....	Yes
Bit of word.....	Yes
Number type conversion.....	Yes
ASCII in, out, print.....	Yes
LCD instruction.....	Yes
Real-time clock/calendar.....	Yes
Internal diagnostics.....	Yes
Password security.....	Yes
System and user error log.....	No
<b>Communications</b>	
Built-in ports:	
One RS-232C	
One multi-function RS232C/RS422/RS485	
<b>NOTE: RS485 is for MODBUS RTU only.</b>	
<b>Protocols supported:</b>	
K-sequence (proprietary protocol).....	Yes
DirectNet Client/Server.....	Yes
Modbus RTU Client/Server.....	Yes
ASCII in/out.....	Yes
Baud rate	
Port 1.....	600 baud (fixed)
Port 2.....	selectable 300-38,400 baud (default 9,600)
<b>Specialty Features</b>	
Filtered inputs.....	Yes3
Interrupt input.....	Yes3
High speed counter.....	Yes, 7kHz3
Pulse output.....	Yes, 10kHz3
Pulse catch input.....	Yes3
<ol style="list-style-type: none"> <li>1- These features are available with use of certain option module. Option module specifications are located later in this section.</li> <li>2- Our 1K program includes contacts, coils, and scan overhead. If you compare our products to others, make sure you include their scan overhead.</li> <li>3- Input features only available on units with DC inputs and output features only available on units with DC outputs.</li> </ol>	

# Features at a Glance

## DirectSOFT software

The DL05 and DL06 PLCs use the same familiar DirectSOFT programming software that our larger PLCs use. A FREE version of DirectSOFT gives you all the great features of the full version, but with a 100-word PLC program download limitation. For programs larger than 100 words, the full package is required. The FREE PC-DS100 software may be sufficient to program the DL05 and DL06. If you are programming with a full package version prior to v6.0, you will need v2.4 or later for the DL05 PLCs and v4.0 or later for the DL06. We always recommend the latest version for the most robust features. See the DirectLOGIC Overview section DL in this catalog for a complete description of DirectSOFT including features, part numbers of programming packages and upgrades.

### Programming

Handheld programmer...D2-HPP \$590.00

DirectSOFT Programming for Windows

PC-DSOFT6 \$462.00

PC-DS100 Free

PC-R60-U (upgrade) \$291.00



## Hardware features diagrams



# Product Dimensions and Installation

It is important to understand the installation requirements for your DL05 or DL06 system. Your knowledge of these requirements will help ensure that your system operates within its environmental and electrical limits.

## Plan for safety

This catalog should never be used as a replacement for the user manual. You can purchase, download free, or view online the user manuals for these products. The [D0-USER-M](#) is the publication for the DL05 PLCs, and the [D0-06USER-M](#) is the publication for the DL06 PLCs. The [D0-OPTIONS-M](#) is the user manual for the option modules. These user manuals contain important safety information that must be followed. The system installation should comply with all appropriate electrical codes and standards.

## Unit dimensions and

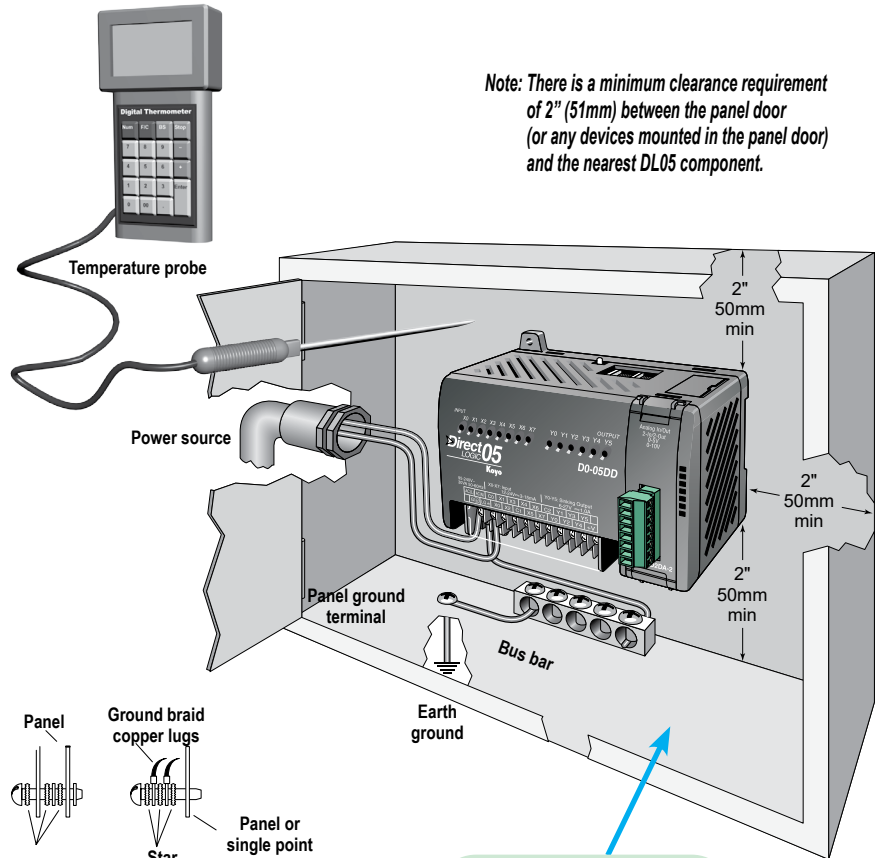

*Note: There is a minimum clearance requirement of 2" (51mm) between the panel door (or any devices mounted in the panel door) and the nearest DL05 component.*



**See the Enclosure section to find an enclosure that fits your application**

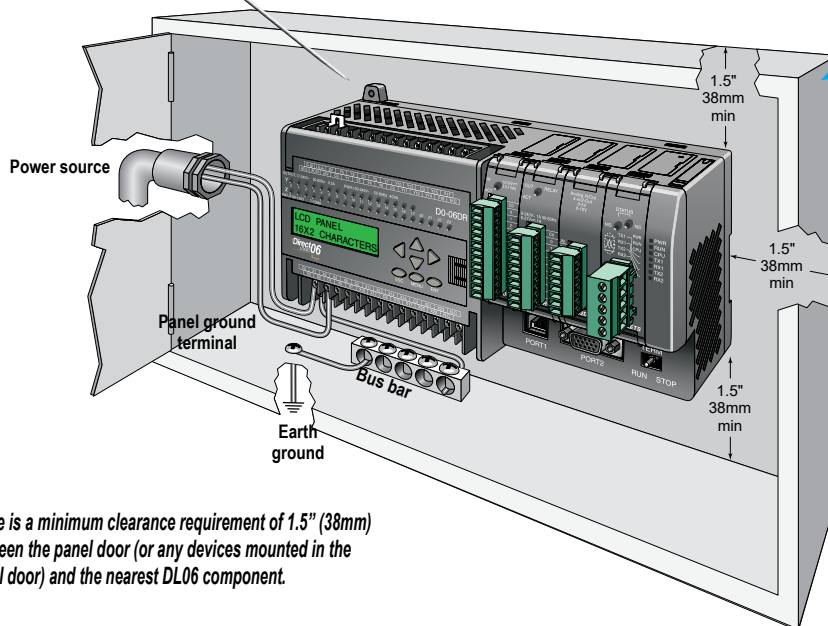

*Note: There is a minimum clearance requirement of 1.5" (38mm) between the panel door (or any devices mounted in the panel door) and the nearest DL06 component.*

Environmental Specifications for DL05 and DL06	
<b>Storage Temperature</b>	-4° F-158°F (-20°C to 70°C)
<b>Ambient Operating Temperature</b>	32°F-131°F (0° to 55°C)
<b>Ambient Humidity</b>	5 to 95% relative humidity (non-condensing)
<b>Vibration Resistance</b>	MIL STD 810C Method 514.2
<b>Shock Resistance</b>	MIL STD 810C Method 516.2
<b>Noise Immunity</b>	NEMA (ICS3-304)
<b>Atmosphere</b>	No corrosive gases

# Product Dimensions and Installation

## Mounting Orientation

DL05 and DL06 PLCs must be mounted properly to ensure ample airflow for cooling purposes. It is important to follow the unit orientation requirements and to verify that the PLC's dimensions are compatible with your application. Notice particularly the grounding requirements and the recommended cabinet clearances.

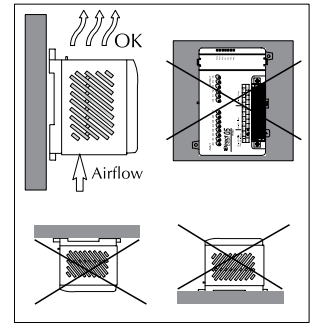
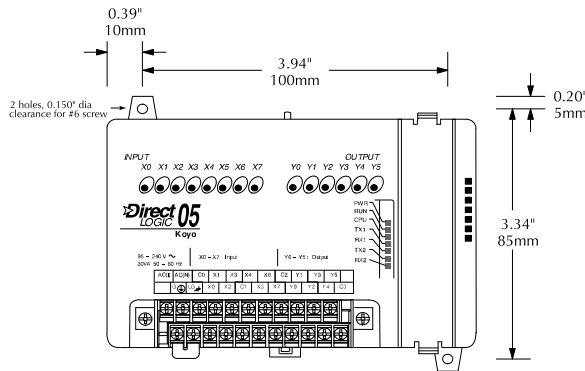

Mounting orientation

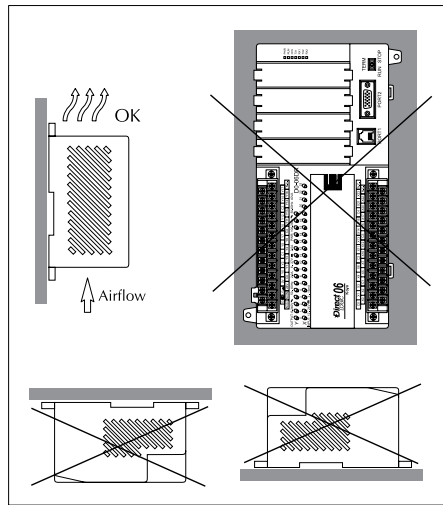

Mounting orientation

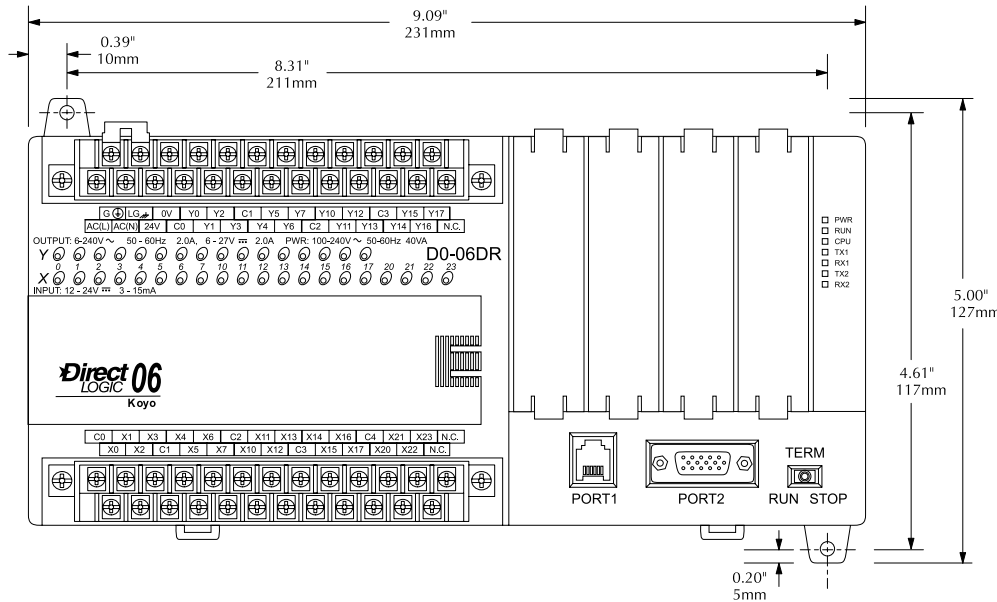
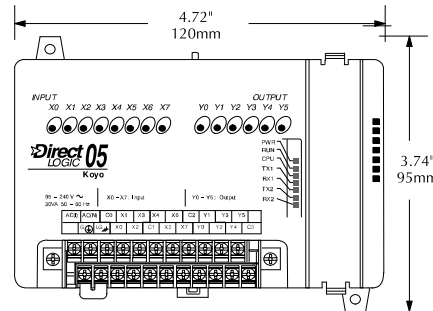



# Choosing I/O Type

DL06 Base Unit I/O Table							
Part Number	Inputs			Outputs			Price
	I/O Type/ Commons	Sink or source	Voltage Ranges	I/O Type/ Commons	Sink or Source	Voltage/Current Ratings	
<a href="#">D0-06AA</a>	AC/5	N/A	90–120 VAC	AC/4	N/A	17–240 VAC, 0.5 A 50/60 Hz	\$471.00
<a href="#">D0-06AR</a>	AC/5	N/A	90–120 VAC	Relay/4	N/A	6–27 VDC, 2A 6–240 VAC, 2A	\$437.00
<a href="#">D0-06DA</a>	DC/5	Sink or source	12–24 VDC	AC/4	N/A	17–240 VAC, 0.5 A 50–60 Hz	\$437.00
<a href="#">D0-06DD1</a>	DC/5	Sink or source	12–24 VDC	DC/4	Sink	6–27 VDC, 0.5 A (Y0-Y1) 6–27 VDC, 1.0 A (Y2-Y17)*	\$387.00
<a href="#">D0-06DD2</a>	DC/5	Sink or source	12–24 VDC	DC/4	Source	12–24 VDC, 0.5 A (Y0-Y1) 12–24 VDC, 1.0 A (Y2-Y17)	\$391.00
<a href="#">D0-06DR</a>	DC/5	Sink or source	12–24 VDC	Relay/4	N/A	6–27 VDC, 2A 6–240 VAC, 2A	\$406.00
<a href="#">D0-06DD1-D</a>	DC/5	Sink or source	12–24 VDC	DC/4	Sink	6–27 VDC, 0.5 A (Y0-Y1) 6–27 VDC, 1.0 A (Y2-Y17)*	\$389.00
<a href="#">D0-06DD2-D</a>	DC/5	Sink or source	12–24 VDC	DC/4	Source	12–24 VDC, 0.5 A (Y0-Y1) 12–24 VDC, 1.0 A (Y2-Y17)	\$392.00
<a href="#">D0-06DR-D</a>	DC/5	Sink or source	12–24 VDC	Relay/4	N/A	6–27 VDC, 2A 6–240 VAC, 2A	\$401.00

\* These outputs must be derated to 0.6 A for EN61131-2 compliance.

Discrete I/O Option Modules							
Part Number	Inputs			Outputs			Price
	I/O Type/ Number/ Commons	Sink or source	Voltage Ranges	I/O Type/ Number/ Commons	Sink or Source	Voltage/Current Ratings	
<a href="#">D0-07CDR</a>	DC/4/1	Sink or source	12–24 VDC	Relay/3/1	N/A	6–27 VDC, 1A 6–240 VAC, 1A	\$100.00
<a href="#">D0-08CDD1</a>	DC/4/2	Sink or source	12–24 VDC	DC/4/2	Sink	6–27 VDC, 0.3 A	\$100.00
<a href="#">D0-08TR</a>	N/A	N/A	N/A	Relay/8/2	N/A	6–27 VDC, 1A 6–240 VAC, 1A	\$100.00
<a href="#">D0-10ND3</a>	DC/10/2	Sink or source	12–24 VDC	N/A	N/A	N/A	\$84.00
<a href="#">D0-10ND3F</a>	DC/10/2	Sink or source	12–24 VDC	N/A	N/A	N/A	\$100.00
<a href="#">D0-10TD1</a>	N/A	N/A	N/A	DC/10/2	Sink	6–27 VDC, 0.3 A	\$102.00
<a href="#">D0-10TD2</a>	N/A	N/A	N/A	DC/10/2	Source	12–24 VDC, 0.3 A	\$102.00
<a href="#">D0-16ND3</a>	DC/16/4	Sink or source	20–28 VDC	N/A	N/A	N/A	\$88.00
<a href="#">D0-16TD1</a>	N/A	N/A	N/A	DC/16/2	Sink	6–27 VDC, 0.1A	\$99.00
<a href="#">D0-16TD2</a>	N/A	N/A	N/A	DC/16/2	Source	12–24 VDC, 0.1A	\$90.00
<a href="#">F0-04TRS</a>	N/A	N/A	N/A	Relay/4/4	N/A	5–30 VDC, 3A 5–125 VAC, 3A	\$73.00
<a href="#">F0-08NA-1</a>	AC/8/2	N/A	80–132 VAC 90–150 VDC	N/A	N/A	N/A	\$89.00
<a href="#">F0-08SIM</a>	8-pt. Input simulator						\$62.00

Communications and Specialty Option Modules		
Part Number	Description	Price
<a href="#">H0-ECOM100</a>	Ethernet Communications Module 10/100 Mbit	\$304.00
<a href="#">D0-DEVNETS</a>	DeviceNET Server Module	\$158.00
<a href="#">H0-CTRIO2</a>	High Speed Counter I/O Module	\$298.00
<a href="#">D0-DCM</a>	Serial Communications Module	\$219.00
<a href="#">F0-CP128</a>	ASCII CoProcessor Module	\$345.00

## Analog I/O

By using option modules, you can add analog inputs or outputs to your DL05 or DL06 PLC. The table below shows the input and output types at a glance. Detailed specifications are provided later in this section.

Analog I/O Option Modules					
Part Number	Inputs		Outputs		Price
	No.	Input Type	No.	Output Type	
<a href="#">F0-04AD-1</a>	4	0-20 mA or 4-20 mA	0	N/A	\$139.00
<a href="#">F0-04AD-2</a>	4	0-5 VDC or 0-10 VDC	0	N/A	\$204.00
<a href="#">F0-08ADH-1</a>	8	0-20 mA	0	N/A	\$235.00
<a href="#">F0-08ADH-2</a>	8	0-5 VDC or 0-10 VDC	0	N/A	\$248.00
<a href="#">F0-04DAH-1</a>	0	N/A	4	4-20 mA	\$251.00
<a href="#">F0-08DAH-1</a>	0	N/A	8	4-20 mA	\$330.00
<a href="#">F0-04DAH-2</a>	0	N/A	4	0-10 VDC	\$236.00
<a href="#">F0-08DAH-2</a>	0	N/A	8	0-10 VDC	\$314.00
<a href="#">F0-4AD2DA-1</a>	4	0-20 mA or 4-20 mA	2	0-20 mA or 4-20 mA	\$336.00
<a href="#">F0-2AD2DA-2</a>	2	0-5 VDC or 0-10 VDC	2	0-5 VDC or 0-10 VDC	\$264.00
<a href="#">F0-4AD2DA-2</a>	4	0-5 VDC or 0-10 VDC	2	0-5 VDC or 0-10 VDC	\$372.00
<a href="#">F0-04RTD</a>	4	RTD	0	N/A	\$345.00
<a href="#">F0-04THM*</a>	4	Thermocouple / Voltage	0	N/A	\$364.00

\* See module specifications page for thermocouple types and voltage input ranges supported

## Power budgeting

No power budgeting is necessary for the DL05. The built-in power supply is sufficient for powering the base unit, any of the option modules, the handheld programmer, and even a [DV1000](#) operator interface.

Power budgeting is necessary for the DL06. With four option module slots and an optional LCD display, it is necessary to verify that sufficient power is available for all optional devices. Power budgeting is described in detail on page 2-29 and in the DL06 User Manual.

# Networking the DL05 and DL06

All DL05 and DL06 PLCs have built-in networking capability. The DL05 family offers two 6-pin, RS-232 ports. You can use these ports for programming, networking, or connecting an operator interface device. The RS-232 ports support point-to-point communications using the optional [D0-CBL](#) cable. If you need to create a multi-drop network or require longer distances between devices, you can use the [FA-ISOCOCON](#) at each DL05 to convert the RS-232 signal to RS-422 or RS-485.

The DL06 family of PLCs offers even greater communications flexibility. Port 1 is a fixed baud rate port identical to port 1 on the DL05 PLCs, but port 2 is a multi-function port that can be used as RS-232, RS-422, or RS-485 (Modbus/ASCII only) without using external converters. This allows you to create multi-drop networks with minimal installation headaches.

## Protocols supported

Each port is capable of communicating using K-sequence, DirectNET and Modbus RTU protocols. Port 1 can only be a Server for each of the protocols. Port 2 can serve as a K-sequence Server or a network Client or Server for either DirectNET or Modbus RTU protocols.

### Serial Bus Protocols

We also offer option modules that allow you to connect a DL05 or DL06 PLC to a variety of networks as a Server device. Our [D0-DEVNETS](#) (DeviceNet) modules plug into any DL05 or DL06 PLC. The [D0-DCM](#) Data Communications module supports DirectNET and Modbus RTU protocols.

## ZIPLink communication adapter modules

The **ZIPLink** communications adapter modules offer fast and convenient screw terminal connection for the bottom port of the DL06 CPU. The adapter modules are RS232/422 DIP switch selectable and are offered with or without indicating LEDs and surge protection. See the Wiring Solutions section in this catalog for more information.

## Optional Ethernet communication modules

Need to connect to a high speed HMI or computer system? We offer a 100Base-T Ethernet communications module. You can use the [H0-ECOM100](#) Ethernet communication module with our Stride

Ethernet switches or with most off-the-shelf Ethernet hubs or switches. The [H0-ECOM100](#) option module plugs into any DL05 or DL06 PLC and supports the industry standard Modbus TCP protocol.

### Point-to-point

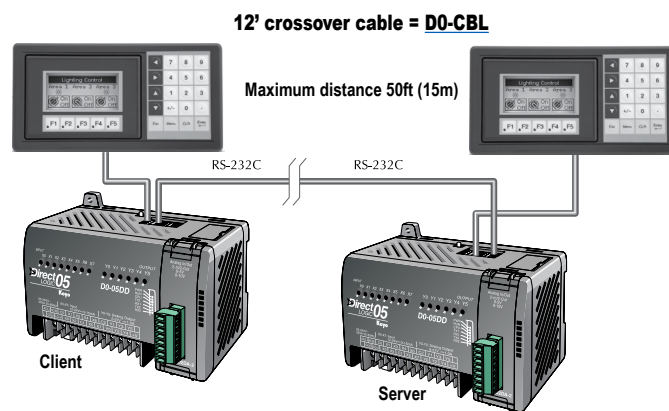

### Multi-drop

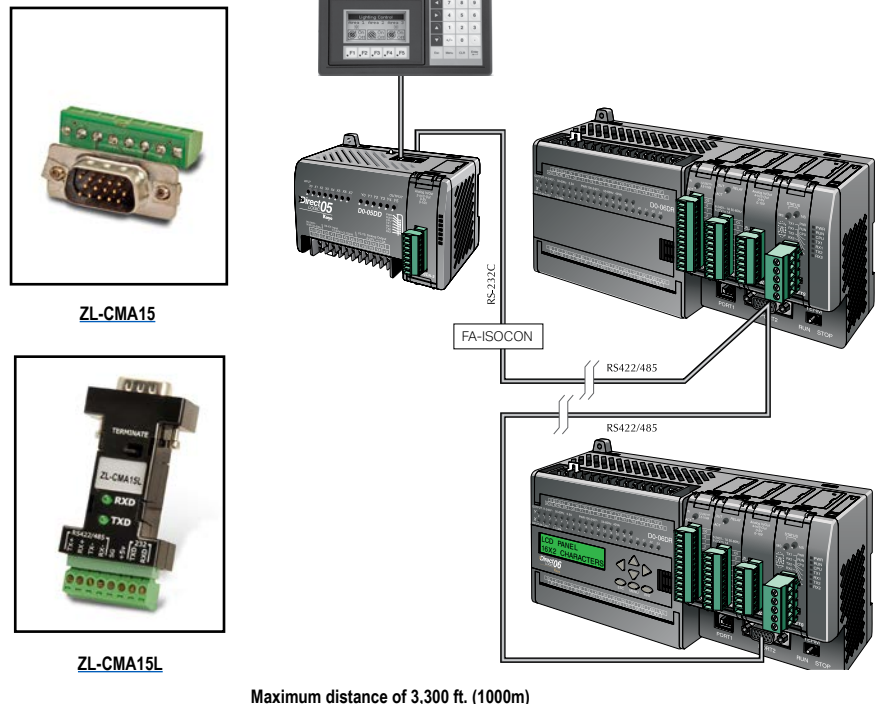

ZL-CMA15

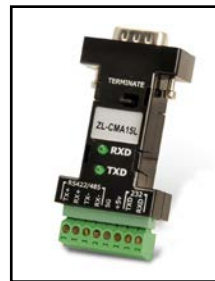

ZL-CMA15L

# Ports, Status Indicators, and Modes

## Port 1

Port 1 is a 6-pin, fixed configuration port and has the same pin assignments on the DL05 and the DL06. Please refer to the table and diagrams on this page. This port can be used to connect to an HPP, DirectSOFT, an operator interface, or other external device. Features include:

- 9600 baud
- 8 data bits
- Odd parity
- 1 start bit, 1 stop bit
- Station address of 1
- Asynchronous, half-duplex, DTE

Protocols supported (as Server):

- K sequence, **DirectNET**, Modbus RTU

DL05 & DL06 Port 1 Pin Descriptions		
1	0V	Power (-) connection (GND)
2	5V	Power (+) connection
3	RXD	Receive data (RS-232C)
4	TXD	Transmit data (RS-232C)
5	5V	Power (+) connection
6	0V	Power (-) connection (GND)

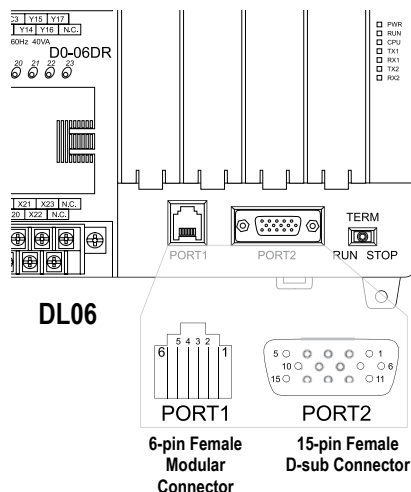
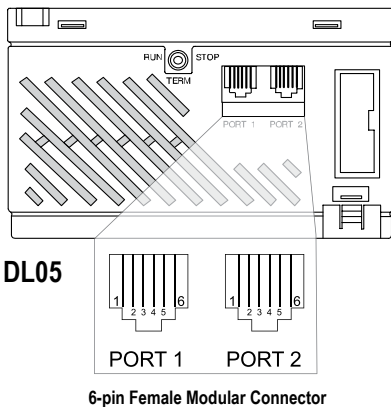

## Port 2

Port 2 is a configurable port on both the DL05 and the DL06 PLCs. The DL05 PLC uses a 6-pin modular connector and offers RS-232 communications and offers RS-232 communications only. The DL06 PLC uses a 15-pin HD-sub connector and offers RS-232, RS-422, or RS-485 communications. Please refer to the table and diagrams on this page for more information. This port can be used to connect to an HPP, DirectSOFT, an operator interface, or other external device. Features of port 2 include:

- 300, 600, 1200, 2400, 4800, 9600 (default), 19,200, 38,400 baud
  - 8 data bits
  - Odd (default), even, or no parity
  - 1 start bit, 1 stop bit
  - Station address:
    - 1 (default)
    - 1-90 DirectNET, K sequence
    - 1-247 Modbus RTU
  - Asynchronous, half-duplex, DTE
- Protocols supported:
- K sequence (Server), **DirectNET** (Client/Server), Modbus (Client/Server)

DL05 Port 2 Pin Descriptions		
1	0V	Power (-) connection (GND)
2	5V	Power (+) connection
3	RXD	Receive data (RS-232C)
4	TXD	Transmit data (RS-232C)
5	RTS	Ready to send
6	0V	Power (-) connection (GND)

DL06 Port 2 Pin Descriptions		
1	5V	Power (+) connection
2	TXD	Transmit data (RS-232C)
3	RXD	Receive data (RS-232C)
4	RTS	Ready to send (RS232C)
5	CTS	Clear to send (RS232C)
6	RXD-	Receive data (-) (RS-422/485)
7	0V	Power (-) connection (GND)
8	0V	Power (-) connection (GND)
9	TXD+	Transmit data (+) (RS-422/485)
10	TXD-	Transmit data (-) (RS-422/485)
11	RTS+	Ready to send (+) (RS-422/485)
12	RTS-	Ready to send (-) (RS-422/485)
13	RXD+	Receive data (+) (RS-422/485)
14	CTS+	Clear to send (+) (RS-422/485)
15	CTS-	Clear to send (-) (RS-422/485)

## DL05 and DL06 status indicators

Status Indicators		
Indicator	Status	Meaning
<b>PWR</b>	ON	Power good
	OFF	Power failure
<b>RUN</b>	ON	CPU is in Run Mode
	OFF	CPU is in Stop or Program Mode
<b>CPU</b>	ON	CPU self diagnostics error
	OFF	CPU self diagnostics good
<b>TX1</b>	ON	Data is being transmitted by the CPU-Port 1
	OFF	No data is being transmitted by the CPU-Port 1
<b>RX1</b>	ON	Data is being received by the CPU-Port 1
	OFF	No data is being received by the CPU-Port 1
<b>TX2</b>	ON	Data is being transmitted by the CPU-Port 2
	OFF	No data is being transmitted by the CPU-Port 2
<b>RX2</b>	ON	Data is being received by the CPU-Port 2
	OFF	No data is being received by the CPU-Port 2

## DL05 and DL06 mode switches

Mode Switch Position	CPU Action
<b>RUN (Run Program)</b>	CPU is forced into the RUN mode if no errors are encountered. No program changes are allowed by the programming/monitoring device.
<b>TERM (Terminal)</b>	RUN PROGRAM and the TEST modes are available. Mode and program changes are allowed by the programming/monitoring device.
<b>STOP</b>	CPU is forced into the STOP mode. No changes are allowed by the programming/monitoring device.

Use the optional low profile 15-pin adapter to make option module wiring easier.



DL05 / DL06 PLCs

tDL5-10



# ASCII and Modbus Instructions

## ASCII instructions for DL06

The DL06 PLC supports several easy-to-use instructions, which allow ASCII strings to be read into or written from the communication ports when using either the CPU port 2, or the **D0-DCM** Data Communications Module port 2.

Raw ASCII: CPU/DCM Port 2 can be used for either reading or writing raw ASCII strings, but not for both.

Embedded ASCII: With these instructions, you can use the DL06 PLC to locate ASCII strings embedded within a supported protocol via CPU/DCM Port.

### Receiving ASCII strings

1. ASCII IN (AIN) - This instruction configures CPU/DCM Port 2 for raw ASCII input strings, with parameters such as fixed and variable length ASCII strings, termination characters, byte swapping options, and instruction control bits. Use barcode scanners, weigh scales, etc., to write raw ASCII input strings into CPU/DCM Port 2 based on the AIN instruction's parameters.
2. Write embedded ASCII strings directly to V-memory from an external HMI (or

similar Client device). The ASCII string is transmitted through CPU/DCM Port 2 using any supported communications protocol. This method uses the familiar RX/WX instructions previously available.

3. If the DL06 is used as a network Client, the Network Read instruction (RX) can be used to read embedded ASCII data from a network Server device. Again, the ASCII string would be transmitted through CPU/DCM Port 2, using any supported communications protocol.

### Writing ASCII strings

1. Print from V-memory (PRINTV) - Use this instruction to write raw ASCII strings out of CPU/DCM port 2 to a display panel, serial printer, etc. The instruction features the starting V-memory address, string length, byte swapping options, etc. When the instruction's permissive bit is enabled, the string is written to CPU/DCM Port 2.
2. Print to V-memory (VPRINT) - Use this instruction to create pre-coded ASCII strings in the PLC (e.g. alarm messages). When the instruction's permissive bit is enabled, the message is loaded into a pre-defined V-memory address location. Then the PRINTV instruction may be used to write the pre-coded ASCII string out of CPU/DCM Port 2. American, European, and Asian Time/Dates taps are supported.
3. Print Message (PRINT) - This existing instruction can be used to create pre-coded ASCII strings in the PLC. When the instruction's permissive bit is enabled, the string is written to CPU/DCM Port 2. The VPRINT/PRINTV instruction combination is more powerful and flexible than the PRINT instruction.
4. If the DL06 PLC is a network Client, the Network Write (WX) can be used to write embedded ASCII data to an HMI or Server device directly from V-memory. This is done via a supported communications protocol using CPU/DCM Port 2.

### More ASCII instructions

ASCII Find (AFIND) - Finds where a specific portion of the ASCII string is located in continuous V-memory addresses.

ASCII Extract (AEX) - Extracts a specific portion (usually some data value) from the ASCII find location or other known ASCII data location.

Compare V-memory (CMPV) - This instruction is used to compare two blocks of V-memory addresses and is usually used to detect a change in an ASCII string. Compared data types must be of the same format (e.g. BCD, ASCII, etc.).

Swap Bytes (SWAPB) - Swaps V-memory bytes on ASCII data that was written directly to V-memory from an external HMI or similar Client device via a communications protocol. The AIN and AEX instructions have a built-in byte swap feature.

The **F0-CP128** option module is also available for more extensive ASCII communications.

## Modbus RTU instructions for DL06

The DL06 CPU/DCM port 2 supports Modbus Read/Write instructions that simplify setup. The MRX and MWX instructions allow you to use native Modbus addressing, eliminating the need for octal to decimal conversions.

Function Codes 05 and 06 and the ability to read Server Exception Codes have been added. These flexible instructions allow the user to select the following parameters within one instruction window:

- 584/984 or 484 Modbus data type
- Server node (0-247)
- Function code
- Starting Client/Server memory address
- Number of bits
- Exception code starting address

# Power Budgeting for the DL06

The DL06 has four option module slots. To determine whether the combination of modules you select will have sufficient power, you will need to perform a power budget calculation.

## Power supplied

Power is supplied from two sources: the internal base unit power supply and, if required, an external supply (customer furnished). The D0-06xx (AC powered) PLCs supply a limited amount of 24VDC power. The 24VDC output can be used to power external devices.

For power budgeting, start by considering the power supplied by the base unit. All DL06 PLCs supply the same amount of 5VDC power. Only the AC units offer 24VDC auxiliary power.

Be aware of the trade-off between 5VDC power and 24VDC power. The amount of 5 VDC power available depends on the amount of 24VDC power being used, and the amount of 24VDC power available depends on the amount of 5VDC power consumed. Determine the amount of internally supplied power from the table to the right.

## Power required by base unit

Because of the different I/O configurations available in the DL06 family, the power consumed by the base unit itself varies from model to model. Subtract the amount of power required by the base unit from the amount of power supplied by the base unit. Be sure to subtract 5VDC and 24VDC amounts.

## Power required by option modules

Next, subtract the amount of power required by the option modules you are planning to use. Again, remember to subtract both 5VDC and 24VDC.

If your power budget analysis shows surplus power available, you should have a workable configuration.

DL06 Power Supplied by Base Units		
Part Number	5 VDC (mA)	24 VDC (mA)
D0-06xx	1500mA	300mA
	2000mA	200mA
D0-06xx-D	1500mA	none

DL06 Base Unit Power Required		
Part Number	5 VDC (mA)	24 VDC (mA)
D0-06AA	800mA	none
D0-06AR	900mA	none
D0-06DA	800mA	none
D0-06DD1	600mA	280mA*
D0-06DD2	600mA	none
D0-06DR	950mA	none
D0-06DD1-D	600mA	none
D0-06DD2-D	600mA	none
D0-06DR-D	950mA	none

\* Only if auxiliary 24VDC power is connected to V+ terminal.

DL06 Power Consumed by Other Devices		
Part Number	5 VDC (mA)	24 VDC (mA)
D0-06LCD	50mA	none
D2-HPP	200mA	none
DV-1000	150mA	none
C-more Micro-Graphic	210mA	none

Power Budgeting Example			
Power Source		5VDC power (mA)	24VDC power (mA)
D0-06DD1 (select row A or B)	A	1500mA	300mA
	B	2000mA	200mA
<b>Current Required</b>		5VDC power (mA)	24VDC power (mA)
D0-06DD1		600mA	280mA*
D0-16ND3		35mA	0
D0-10TD1		150mA	0
D0-08TR		280mA	0
F0-4AD2DA-1		100mA	0
D0-06LCD		50mA	0
<b>Total Used</b>		1215mA	280mA
<b>Remaining</b>	A	285mA	20mA
	B	785mA	note 1

\* Auxiliary 24 VDC used to power V+ terminal of D0-06DD1 sinking outputs.

Note 1: If the PLC's auxiliary 24 VDC power source is used to power the sinking outputs, use power choice A, above.

DL05/06 Power Consumed by Option Modules		
Part Number	5 VDC (mA)	24 VDC (mA)
D0-07CDR	130mA	none
D0-08CDD1	100mA	none
D0-08TR	280mA	none
D0-10ND3	35mA	none
D0-10ND3F	35mA	none
D0-10TD1	150mA	none
D0-10TD2	150mA	none
D0-16ND3	35mA	none
D0-16TD1	200mA	none
D0-16TD2	200mA	none
F0-04TRS	250mA	none
F0-08NA-1	5mA	none
F0-04AD-1	50mA	none
F0-04AD-2	75mA	none
F0-08ADH-1	25mA	25mA
F0-08ADH-2	25mA	25mA
F0-04DAH-1	25mA	150mA
F0-08DAH-1	25mA	220mA
F0-04DAH-2	25mA	30mA
F0-08DAH-2	25mA	30mA
F0-2AD2DA-2	50mA	30mA
F0-4AD2DA-1	100mA	40mA
F0-4AD2DA-2	100mA	none
F0-04RTD	70mA	none
F0-04THM	30mA	none
D0-DEVNETS	45mA	none
H0-CTRIO2	250mA	none
H0-ECOM100	300mA	none
F0-08SIM	1mA	none
D0-DCM	250 mA	none
F0-CP128	150 mA	none
F0-08SIM	1 mA	none

# DL06 LCD Display

The optional [D0-06LCD](#) (\$124.00) is a cost effective LCD display panel that is easy to install. This device is available exclusively for the DL06 PLCs.

## 16 X 2 backlit display

The 16 character x 2 row display mounts directly on the face of the PLC. The LCD is backlit and is accessible using the seven function keys on the front of the display.

## Monitor or change data values

You can view V-memory registers, I/O status, PLC mode, or system errors without interrupting the PLC's control function.

Display messages required for alarm or monitoring purposes can be pre-programmed or imported as ASCII data.

## Password protection

Two layers of password protection prevent unauthorized changes to clock and calendar setup and V-memory data values. Individuals with password authorization can change clock, calendar, V-memory values, force bits on or off, etc.

One simple ladder instruction is used to set up the display. The LCD configuration instruction is available in DirectSOFT, version 4.0 or later.

Note: The [D2-HPP](#) handheld programmer does not support DL06 LCD configuration.

The DL06 User Manual ([D0-06USER-M](#)) describes more fully the installation and operation of the [D0-06LCD](#). Be sure to consult this manual before installing the DL06 LCD. The manual is available free on our Web site, or it can be purchased separately.

## Snap-in installation

The display installs easily into any model DL06 PLC.

Note: Remove power to the PLC before installing or removing the LCD display.

Remove the plastic cover (located between the input and output terminals) by sliding the cover to the left. In its place, slide in the LCD display until it snaps into place.

Display or change individual bits (up to 16 bits per screen) or 32-bit double word values from V-memory.

## Buzzer

The piezoelectric buzzer can be configured to provide pushbutton feedback.

## Keypad navigation

Seven function keys on the face of the LCD display provide navigation through messages or menu items. Messages fall into two categories:

- Error messages
- User-defined pre-programmed messages

At power-up the default screen is displayed. The default screen can be user-defined.

Seven menu choices allow you to view or change all accessible data values (see next page).

