

WEG CWC Series Miniature Contactors

The CWC series mini contactors are a complete solution for switching and controlling motors. The CWC's compact dimensions for its IEC current rating, up to 22A, AC-3 utilization category, allows it to take up less space inside electrical enclosures while still maintaining a powerful 15hp @ 460V. Dimensions of the 7A to 16A contactors are the same for both AC or DC coil voltages, making the panel design and assembly easier. DC models feature low consumption coils allowing the CWC to be operated directly from a PLC without interface relays.

Features

- Rated up to 15hp @ 460V
- Direct mounting to the WEG RW17D overload relay
- Frame size is identical for AC and DC coil contactors up to 16A (CWC07-16).
- CWC025 frame available with AC coil only
- Heavy-duty operation
- Tool-free DIN-rail mounting
- WEG 18-month warranty
- Snap-on accessories
- DC coil low consumption: 1.7–2.7 W
- DC coil standard consumption: 2.6–3.7 W

Agency Approvals/ Certifications

- cULus listed (File No. E202315/E189202)
- CE marked low voltage directive 2006/95/EC

Standards

- IEC/EN 60947-1
- UL 508
- CSA-C22.2 No. 14



More Horsepower in a Smaller Frame

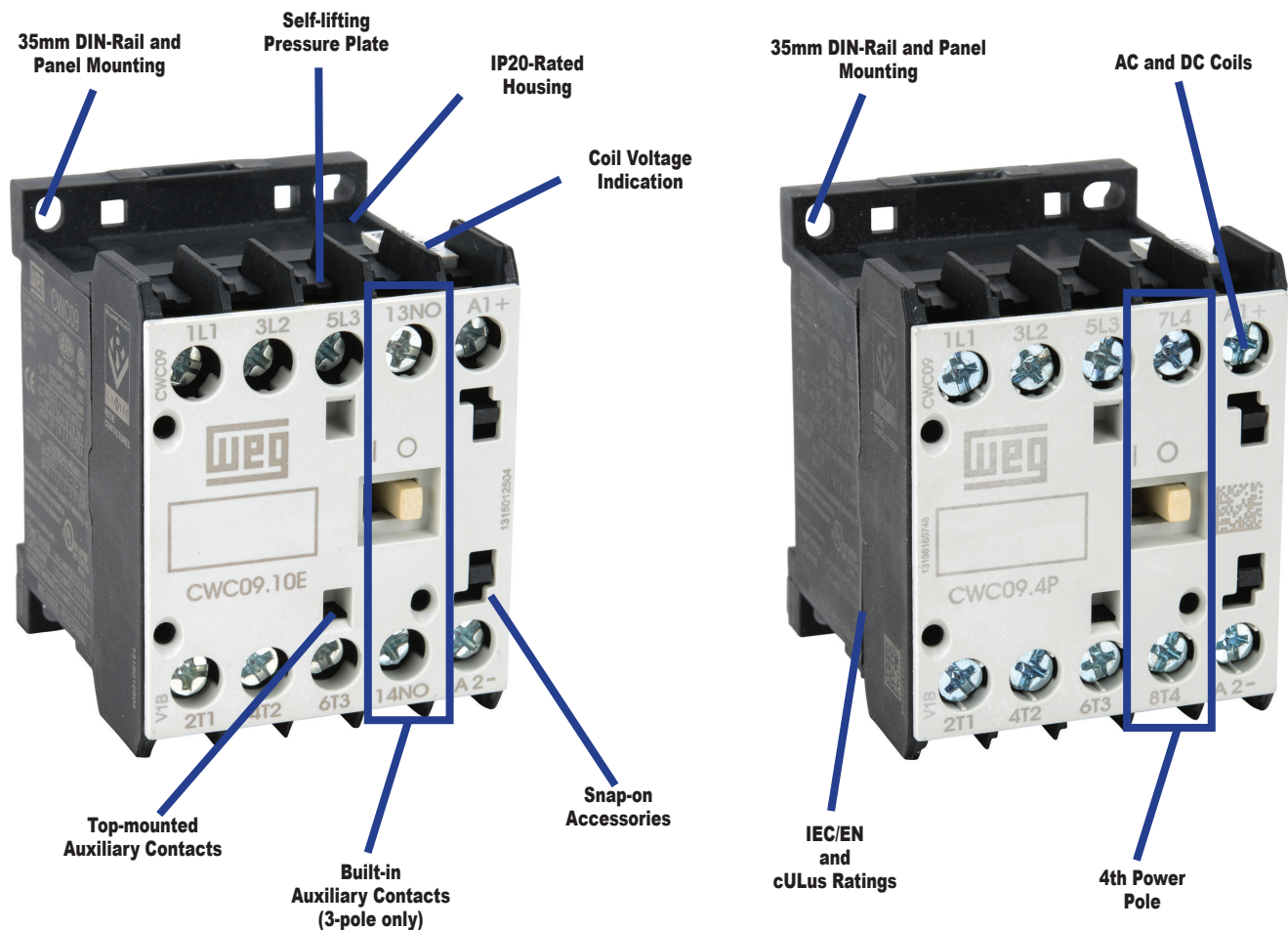



CWC Series Miniature Contactors

Overview

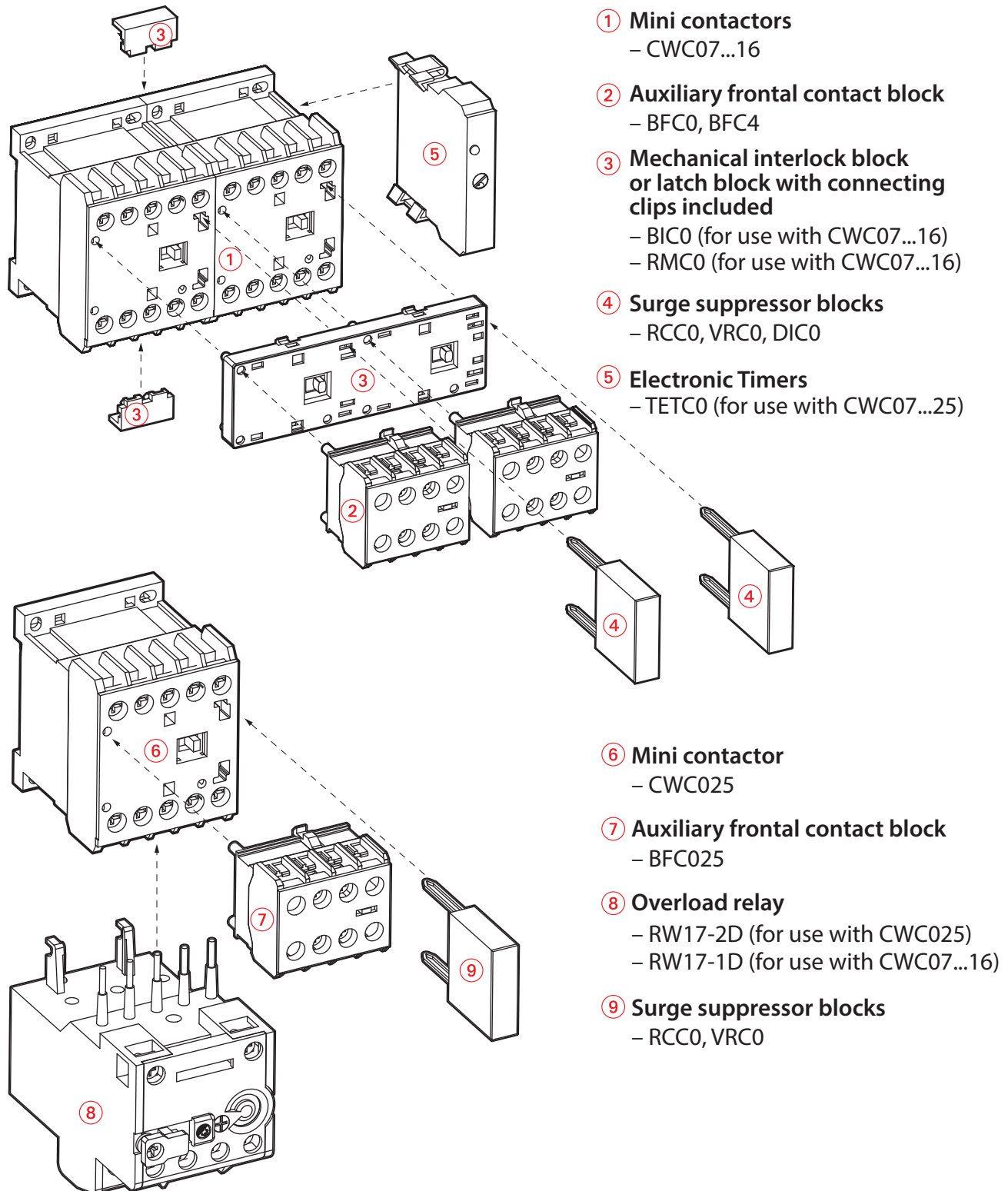

- ① **Mini contactors**
– CWC07...16
- ② **Auxiliary frontal contact block**
– BFC0, BFC4
- ③ **Mechanical interlock block or latch block with connecting clips included**
– BIC0 (for use with CWC07...16)
– RMC0 (for use with CWC07...16)
- ④ **Surge suppressor blocks**
– RCC0, VRC0, DIC0
- ⑤ **Electronic Timers**
– TETC0 (for use with CWC07...16)
- ⑥ **Mini contactor**
– CWC025
- ⑦ **Auxiliary frontal contact block**
– BFC025
- ⑧ **Overload relay**
– RW17-2D (for use with CWC025)
– RW17-1D (for use with CWC07...16)
- ⑨ **Surge suppressor blocks**
– RCC0, VRC0



CWC Series Miniature Contactors Configuration

Three-Pole Contactors

Three-Pole Mini Contactors with AC Coil (IEC/EN – 60947-1)													
Part Number	Price	Current Rating		Maximum Rated Operational Power kW [hp]						Number of Contacts			Coil Voltage and Frequency
		AC-3 (A)	AC-1 (A)	220V 230V	380V	400V 415V	440V	500V	660V 690V	Main	Built-in Aux Contacts		
											N.O.	N.C.	
CWC07-10-30V04	\$14.50	7	18	1.5 [2]	3 [4]	3 [4]	3.7 [5]	3.7 [5]	3 [4]	3	1	–	24VAC 60Hz
CWC07-10-30V18	\$14.50									3	1	–	120VAC 60Hz/110VAC 50Hz
CWC07-10-30V24	\$14.50									3	1	–	208-240 VAC 60Hz
CWC07-10-30V47	\$14.50									3	1	–	480VAC 60Hz/400-415 VAC 50Hz
CWC07-01-30V04	\$14.50									3	–	1	24VAC 60Hz
CWC07-01-30V18	\$14.50									3	–	1	120VAC 60Hz/110VAC 50Hz
CWC07-01-30V24	\$14.50									3	–	1	208-240 VAC 60Hz
CWC07-01-30V47	\$14.50									3	–	1	480VAC 60Hz/400-415 VAC 50Hz
CWC09-10-30V04	\$15.50	9	20	2.2 [3]	4 [5.4]	4 [5.4]	4.5 [6]	4.5 [6]	4 [5.4]	3	1	–	24VAC 60Hz
CWC09-10-30V18	\$15.50									3	1	–	120VAC 60Hz/110VAC 50Hz
CWC09-10-30V24	\$15.50									3	1	–	208-240 VAC 60Hz
CWC09-10-30V47	\$15.50									3	1	–	480VAC 60Hz/400-415 VAC 50Hz
CWC09-01-30V04	\$15.50									3	–	1	24VAC 60Hz
CWC09-01-30V18	\$15.50									3	–	1	120VAC 60Hz/110VAC 50Hz
CWC09-01-30V24	\$15.50									3	–	1	208-240 VAC 60Hz
CWC09-01-30V47	\$15.50									3	–	1	480VAC 60Hz/400-415 VAC 50Hz
CWC012-10-30V04	\$18.50	12	22	3 [4]	5.5 [7.5]	5.5 [7.5]	5.5 [7.5]	5.5 [7.5]	5.5 [7.5]	3	1	–	24VAC 60Hz
CWC012-10-30V18	\$18.50									3	1	–	120VAC 60Hz/110VAC 50Hz
CWC012-10-30V24	\$18.50									3	1	–	208-240 VAC 60Hz
CWC012-10-30V47	\$18.50									3	1	–	480VAC 60Hz/400-415 VAC 50Hz
CWC012-01-30V04	\$18.50									3	–	1	24VAC 60Hz
CWC012-01-30V18	\$18.50									3	–	1	120VAC 60Hz/110VAC 50Hz
CWC012-01-30V24	\$18.50									3	–	1	208-240 VAC 60Hz
CWC012-01-30V47	\$18.50									3	–	1	480VAC 60Hz/400-415 VAC 50Hz
CWC016-10-30V04	\$21.00	16	22	4 [5.4]	7.5 [10]	7.5 [10]	7.5 [10]	7.5 [10]	7.5 [10]	3	1	–	24VAC 60Hz
CWC016-10-30V18	\$21.00									3	1	–	120VAC 60Hz/110VAC 50Hz
CWC016-10-30V24	\$21.00									3	1	–	208-240 VAC 60Hz
CWC016-10-30V47	\$21.00									3	1	–	480VAC 60Hz/400-415 VAC 50Hz
CWC016-01-30V04	\$21.00									3	–	1	24VAC 60Hz
CWC016-01-30V18	\$21.00									3	–	1	120VAC 60Hz/110VAC 50Hz
CWC016-01-30V24	\$21.00									3	–	1	208-240 VAC 60Hz
CWC016-01-30V47	\$21.00									3	–	1	480VAC 60Hz/400-415 VAC 50Hz
CWC025-00-30V04	\$24.00	22	32	5.5 [7.5]	11 [15]	11 [15]	11 [15]	11 [15]	11 [15]	3	–	–	24VAC 60Hz
CWC025-00-30V18	\$24.00									3	–	–	120VAC 60Hz/110VAC 50Hz
CWC025-00-30V24	\$24.00									3	–	–	208-240 VAC 60Hz
CWC025-00-30V47	\$24.00									3	–	–	480VAC 60Hz/400-415 VAC 50Hz
Three-Pole Mini Contactors with DC Coil (IEC/EN – 60947-1)													
CWC07-10-30L02	\$18.50	7	18	1.5 [2]	3 [4]	3 [4]	3.7 [5]	3.7 [5]	3 [4]	3	1	–	12VDC low consumption
CWC07-10-30L03	\$18.50									3	1	–	24VDC low consumption
CWC07-01-30L02	\$18.50									3	–	1	12VDC low consumption
CWC07-01-30L03	\$18.50									3	–	1	24VDC low consumption
CWC09-10-30L02	\$20.50	9	20	2.2 [3]	4 [5.4]	4 [5.4]	4.5 [6]	4.5 [6]	4 [5.4]	3	1	–	12VDC low consumption
CWC09-10-30L03	\$20.50									3	1	–	24VDC low consumption
CWC09-01-30L02	Retired									3	–	1	12VDC low consumption
CWC09-01-30L03	\$20.50									3	–	1	24VDC low consumption
CWC012-10-30L02	\$22.00	12	22	3 [4]	5.5 [7.5]	5.5 [7.5]	5.5 [7.5]	5.5 [7.5]	5.5 [7.5]	3	1	–	12VDC low consumption
CWC012-10-30L03	\$22.00									3	1	–	24VDC low consumption
CWC012-01-30L02	\$22.00									3	–	1	12VDC low consumption
CWC012-01-30L03	\$22.00									3	–	1	24VDC low consumption
CWC016-10-30L02	\$24.00	16	22	4 [5.4]	7.5 [10]	7.5 [10]	7.5 [10]	7.5 [10]	7.5 [10]	3	1	–	12VDC low consumption
CWC016-10-30L03	\$24.00									3	1	–	24VDC low consumption
CWC016-01-30L02	\$24.00									3	–	1	12VDC low consumption
CWC016-01-30L03	\$24.00									3	–	1	24VDC low consumption

Note: Low consumption 12VDC and 24VDC contactors can only use 2-pole auxiliary contact blocks.

WEG CWC Series Miniature Contactors Configuration

Four-Pole Contactors

Four-Pole Mini Contactors with AC Coil (IEC/EN – 60947-1)												
Part Number	Price	Current Rating		Maximum Rated Operational Power KW [hp]						Number of Main Contacts		Coil Voltage and Frequency
		AC-3 (A)	AC-1 (A)	230V 230V	380V	400V 415V	440V	500V	660V 690V	NO	NC	
		CWC07-00-40V04	\$16.00	7	18	1.5 [2]	3 [4]	3 [4]	3.7 [5]	3.7 [5]	3 [4]	
CWC07-00-40V18	\$16.00	4	–									120VAC 60Hz/110VAC 50Hz
CWC07-00-40V24	\$16.00	4	–									208-240 VAC 60Hz
CWC07-00-40V47	\$16.00	4	–									480VAC 60Hz/400-415 VAC 50Hz
CWC07-00-22V04	\$16.00	2	2									24VAC 60Hz
CWC07-00-22V18	\$16.00	2	2									120VAC 60Hz/110VAC 50Hz
CWC07-00-22V24	\$16.00	2	2									208-240 VAC 60Hz
CWC07-00-22V47	\$16.00	2	2									480VAC 60Hz/400-415 VAC 50Hz
CWC09-00-40V04	\$17.50	9	20	2.2 [3]	4 [5.4]	4 [5.4]	4.5 [6]	4.5 [6]	4 [5.4]	4	–	24VAC 60Hz
CWC09-00-40V18	\$17.50									4	–	120VAC 60Hz/110VAC 50Hz
CWC09-00-40V24	\$17.50									4	–	208-240 VAC 60Hz
CWC09-00-40V47	\$17.50									4	–	480VAC 60Hz/400-415 VAC 50Hz
CWC09-00-22V04	\$17.50									2	2	24VAC 60Hz
CWC09-00-22V18	\$17.50									2	2	120VAC 60Hz/110VAC 50Hz
CWC09-00-22V24	\$17.50									2	2	208-240 VAC 60Hz
CWC09-00-22V47	Retired									2	2	480VAC 60Hz/400-415 VAC 50Hz
CWC016-00-40V04	\$23.50	16	22	4 [5.4]	7.5 [10]	7.5 [10]	7.5 [10]	7.5 [10]	7.5 [10]	4	–	24VAC 60Hz
CWC016-00-40V18	\$23.50									4	–	120VAC 60Hz/110VAC 50Hz
CWC016-00-40V24	\$23.50									4	–	208-240 VAC 60Hz
CWC016-00-40V47	\$23.50									4	–	480VAC 60Hz/400-415 VAC 50Hz
CWC016-00-22V04	\$23.50									2	2	24VAC 60Hz
CWC016-00-22V18	\$23.50									2	2	120VAC 60Hz/110VAC 50Hz
CWC016-00-22V24	\$23.50									2	2	208-240 VAC 60Hz
CWC016-00-22V47	\$23.50									2	2	480VAC 60Hz/400-415 VAC 50Hz
Four-Pole Mini Contactors with DC Coil (IEC/EN – 60947-1)												
CWC07-00-40L02	Retired	7	18	1.5 [2]	3 [4]	3 [4]	3.7 [5]	3.7 [5]	3 [4]	4	–	12VDC Low consumption
CWC07-00-40L03	\$19.50									4	–	24VDC Low consumption
CWC07-00-22R02	Retired									2	2	12VDC Standard consumption
CWC07-00-22R03	\$19.50									2	2	24VDC Standard consumption
CWC09-00-40L02	\$21.00	9	20	2.2 [3]	4 [5.4]	4 [5.4]	4.5 [6]	4.5 [6]	4 [5.4]	4	–	12VDC Low consumption
CWC09-00-40L03	\$21.00									4	–	24VDC Low consumption
CWC09-00-22R02	\$21.00									2	2	12VDC Standard consumption
CWC09-00-22R03	\$21.00									2	2	24VDC Standard consumption
CWC016-00-40L02	\$27.00	16	22	4 [5.4]	7.5 [10]	7.5 [10]	7.5 [10]	7.5 [10]	7.5 [10]	4	–	12VDC Low consumption
CWC016-00-40L03	\$27.00									4	–	24VDC Low consumption
CWC016-00-22R02	\$27.00									2	2	12VDC Standard consumption
CWC016-00-22R03	\$27.00									2	2	24VDC Standard consumption

Note: Low consumption 12VDC and 24VDC contactors can only use 2-pole auxiliary contact blocks.

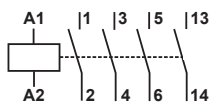

CWC07-10...cwc016-10

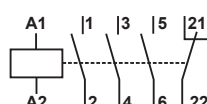

CWC07-01...cwc016-01

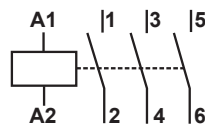

CWC025-00

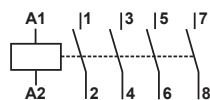

CWC07-00-40...cwc016-00-40

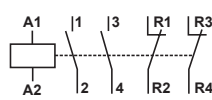

CWC07-00-22...cwc016-00-22

Weg CWC Series Miniature Contactors Configuration

How to Identify Your Part Number



MINIATURE CONTACTOR SERIES CWC

FRAME RATING	
07	7A
09	9A
012	12A
016	16A
025	22A

BUILT-IN AUXILIARY CONTACTS	
00	None
10	1 NO (13 – 14 NO)
01	1 NC (21 – 22 NC)

COIL VOLTAGE	
VAC COIL	
V04	24VAC 60Hz
V18	120VAC 60Hz
V24	208-240 VAC 60Hz
V47	480VAC 60Hz
VDC Coil (std consumption)	
R02	12VDC
R03	24VDC
VDC Coil (low consumption)	
L02	12VDC
L03	24VDC

POWER POLE	
30	CWC0 with 3 NO Power Poles (L1/T1, L2/T2, L3/T3)
22	CWC0 with 2 NO + 2 NC Power Poles (L1/T1, L2/T2, L3/T3, L4/T4)
40	CWC0 with 4 NO Power Poles (L1/T1, L2/T2, L3/T3, L4/T4)

Note: For reference only. Not intended to build a part number.

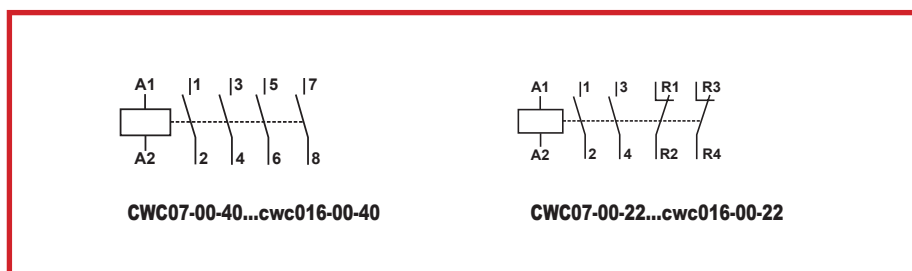



CWC Series Miniature Contactors

Technical Characteristics

CWC Miniature Contactors General Technical Characteristics

Contactors Part Numbers			CWC07	CWC09	CWC012	CWC016	CWC025
Standards			IEC/EN 60947-1, IEC/EN 60947-4, DIN VDE 0660(102), UL508				
Rated Insulation Voltage U_i (Pollution Degree 3)	IEC/EN 60947-4-1, VDE 0660	(V)	690				
	UL, CSA	(V)	600				
Rated Impulse Withstand Voltage U_{imp}	(IEC/EN 60947-1)	(kV)	4				
Rated Operational Frequency (Contact Switchable)		(Hz)	25-400				
Mechanical Lifespan	AC coil	Ops x 10 ⁶	10			3	
	DC coil	Ops x 10 ⁶	12			-	
Electrical Lifespan	I_e AC-3	Ops x 10 ⁶	1.4	1.3	1.2	1.1	0.6
Degree of Protection (VDE 0160)	Main circuits		IP20				
	Control circuits and auxiliary contacts		IP20				
Mounting			Screw or DIN-rail 35mm (EN 50022)				
Coil Terminals			2				
Vibration Resistance	Contactors open		2				
	Contactors closed		4				
Mechanical Shock Resistance (½ sinusoid = 11ms)	Contactors open		6				
	Contactors closed		10				
Ambient Temperature	Operation		-25 to +55°C [-13 to +131°F]				
	Storage		-55 to +80°C [-67 to +176°F]				
Maximum Operating Altitude (Without Derating)			Up to 3000m [9842.5 ft]				
Altitude derating	0.72 x rated hp		3000 – 4000 m [9842.5 – 13123.4 ft]				
	0.60 x rated hp		4000 – 5000 m [13123.4 – 16404.2 ft]				

UL508 and IEC/EN Specifications

Contactors part numbers			CWC07	CWC09	CWC012	CWC016	CWC025
Standards			UL508/CSA Ratings				
Rated Operating Voltage		(V)	600				
UL General Purpose Rating		(A)	18	20	22	22	30
Switching Motor Loads Full Voltage		(Hz)	50/60				
1-phase	115V	(A)	7.2	7.2	9.8	16	20
	230V	(A)	6.9	8	12	12	17
	115V	(hp)	1/3	1/3	1/2	1	1-1/2
	230V	(hp)	3/4	1	2	2	3
3-phase	208V	(A)	6.9	7.8	11	11	17.5
	230V	(A)	6	9.6	9.6	15.2	22
	460V	(A)	7.6	7.6	11	14	21
	575V	(A)	6.1	9	9	11	17
	208V	(hp)	1-1/2	2	3	3	5
	230V	(hp)	1-1/2	3	3	5	7-1/2
	460V	(hp)	5	5	7-1/2	10	15
575V	(hp)	5	7-1/2	7-1/2	10	15	
Short Circuit Current Rating (SCCR)	600V	(kA)	5	5	5	5	5
Standards			IEC Ratings (IEC/EN 60947)				
Rated Operating Voltage		(V)	690				
Rated Thermal Current I_{th}	AC-1 ($\leq 55^\circ\text{C}$)	(A)	18	20	22	22	32
	AC-3 ($U_e \leq 440\text{V}$)	(A)	7	9	12	16	22
Switching Motor Loads		(Hz)	50/60				
3-phase	220-240 V	(A)	7	9	12	16	22
	380-400 V	(A)	7	9	12	16	22
	415-440 V	(A)	7	9	12	16	22
	500V	(A)	6.2	7.5	8.8	13	16
	660-690 V	(A)	4.5	5.5	6.6	10	13
	220-240 V	(kW)	1.5	2.2	3	3.7	5.5
	380-400 V	(kW)	3	3.7	5.5	7.5	11
	415-440 V	(kW)	3.7	4.5	5.5	7.5	11
	500V	(kW)	3.7	4.5	5.5	7.5	11
	660-690 V	(kW)	3	3.7	5.5	7.5	11



CWC Series Miniature Contactors

Technical Characteristics

Control Circuit - Alternating Current (AC)							
Contactor part numbers			CWC07	CWC09	CWC012	CWC016	CWC025
Rated Insulation Voltage U_i (Pollution Degree 3)	IEC/EN 60947-4-1, VDE 0660	(V)	1000				
	UL, CSA	(V)	600				
Coils Rated Voltage	50Hz	(V)	10-550				
	60Hz	(V)	12-660				
	50/60 Hz	(V)	12-660				
Coil operating limits							
Coil 60Hz	Pick up percent of voltage	(%)	40-76				
	Drop out percent of voltage	(%)	25-65				
Coil 50/60 Hz	Pick up percent of voltage	(%)	50-80				
	Drop out percent of voltage	(%)	20-60				
Average consumption							
Coil 60Hz	Magnetic circuit closed	(VA)	2.5-3.5			10.8-13.2	
	Power factor	(cos ϕ)	0.28			0.32	
	Power dissipation per pole	(W)	2.6			-	
	Magnetic circuit closing	(VA)	35			72	
	Power factor	(cos ϕ)	0.85			0.93	
Coil 50/60 Hz	Magnetic circuit closed	(VA)	2-3			4.56-5.8	
	Magnetic circuit closing	(VA)	30			58	
Average Time	Closing NO contacts	(ms)	8-20			13-16	
	Opening NO contacts	(ms)	6-13			13.5-17	

Control Circuit - Direct Current (DC)						
Contactor Part Numbers			CWC07, CWC09, CWC012, CWC016			
Coil Type			Standard	Low consumption	4P (2P/2R)	
Rated Insulation Voltage U_i (Pollution Degree 3)	IEC/EN 60947-4-1, VDE 0660	(V)	1000			
	UL, CSA	(V)	600			
Standard Voltages			(V) 12-440			
Coil operating limits						
Coil Operating Limits	Pick up percent of voltage	(%)	40-70			
	Drop out percent of voltage	(%)	15-40			
Power consumption						
Power Consumption	Magnetic circuit closed	(W)	2.6-3.7	1.7-2.7	2.9-4	
	Magnetic circuit closing	(W)	2.6-3.7	1.7-2.7	2.9-4	
Operation Time	Closing NO contacts	(ms)	35-45			
	Opening NO contacts	(ms)	7-12			



CWC Series Miniature Contactors

Technical Characteristics

CWC Series Miniature Contactors Power Circuit							
Contactor Part Numbers			CWC07	CWC09	CWC012	CWC016	CWC025
Rated Operational Current I_e	AC-3 ($U_e \leq 440V$)	(A)	7	9	12	16	22
	AC-4 ($U_e \leq 440V$)	(A)	2.8	3.5	4.5	5	9
	AC-1 ($\theta m 55^\circ C, U_e \leq 690V$)	(A)	18	20	22	22	32
Rated Operational Voltage U_e	IEC/EN 60947-4-1, VDE 0660	(V)	690				
	UL, CSA ¹	(V)	600				
Rated Thermal Current I_{th} ($\theta \leq 55^\circ C$)		(A)	18	20	22	22	32
Making capacity - IEC/EN 60947		(A)	70	90	120	160	250
Breaking Capacity IEC/EN 60947	($U_e \leq 400V$)	(A)	50	72	96	128	200
	($U_e = 500V$)	(A)	50	72	96	128	200
	($U_e = 690V$)	(A)	35	54	72	96	150
Short-time Current (No Current Flowing During Recovery Time of 10 min and $\theta \leq 40^\circ C$)	1 sec	(A)	250	250	250	250	-
	5 sec	(A)	125	125	125	125	-
	10 sec	(A)	95	95	95	95	-
	30 sec	(A)	70	70	70	70	-
	1 min	(A)	50	50	50	50	-
	3 min	(A)	40	40	40	40	-
Protection Against Short-Circuits With Fuses (IEC gL/gG) ² or UL Class CC	@ 600V - UL/CSA ¹	(kA)	5				
	Coordination type 1	(A)	35	35	35	35	50
	Coordination type 2	(A)	20	20	25	25	35
Average Impedance Per Pole		(m Ω)	6	6	5	5	6
Average Power Dissipation Per Pole	AC-1	(W)	1.9	2.4	2.4	2.4	6.1
	AC-3	(W)	0.3	0.5	0.7	1.3	3.8
Utilization Category AC-3							
Rated Operational Current I_e ($\theta \leq 55^\circ C$)	($U_e \leq 440V$)	(A)	7	9	12	16	22
	($U_e \leq 500V$)	(A)	6.2	7.5	8.8	13	16
	($U_e \leq 690V$)	(A)	4.5	5.5	6.6	10	13
	($U_e \leq 1000V$)	(A)	Not available				
Rated Operational Power	220/230 V	(kW)	1.5	2.2	3	3.7	5.5
		(hp)	2	3	4	5	7.5
	380V	(kW)	3	3.7	5.5	7.5	11
		(hp)	4	5	7.5	10	15
	400/415 V	(kW)	3	3.7	5.5	7.5	11
		(hp)	4	5	7.5	10	15
	440V	(kW)	3.7	4.5	5.5	7.5	11
		(hp)	5	6	7.5	10	15
	500V	(kW)	3.7	4.5	5.5	7.5	11
		(hp)	5	6	7.5	10	15
	660/690 V	(kW)	3	3.7	5.5	7.5	11
		(hp)	4	5	7.5	10	15
Maximum Electrical Operations per Hour	600 ops/hr	(%)	100	100	100	100	100
	1200 ops/hr	(%)	75	75	75	75	75
	3000 ops/hr	(%)	50	50	50	50	50
Utilization Category AC-4							
Rated Operational Current I_e AC-4 ($U_e \leq 440 V$)		(A)	2.8	3.5	4.5	5	9
Rated Operational Power (200,000 Operations)	220/230 V	(kW)	0.55	0.75	0.75	1.1	2.2
		(hp)	0.7	1	1	1.5	2.9
	380/400 V	(kW)	1.1	1.1	1.8	2.2	4
		(hp)	1.5	1.5	2.4	2.9	5.4
	415V	(kW)	1.1	1.5	2.2	2.2	4.5
		(hp)	1.5	2	2.9	2.9	6
	440V	(kW)	1.1	1.5	2.2	2.2	4.5
		(hp)	1.5	2	2.9	2.9	6
	500V	(kW)	1.1	1.5	2.2	2.2	4.5
		(hp)	1.5	2	2.9	2.9	6
	660/690 V	(kW)	1.1	1.5	2.2	2.2	4.5
		(hp)	1.5	2	2.9	2.9	6

¹Note: Specifications only valid for 50/60 Hz three-phase, 4 poles WEG standard motors.

²Note: Not sold by Automation Direct.



CWC Series Miniature Contactors

Technical Characteristics

Built-In Auxiliary Contacts Technical Characteristics			
Standards	IEC 60947-5-1, IEC 60947-4-1		
Rated Insulation Voltage U_i (Pollution Degree 3)	IEC, VDE 0660	(V)	690
	UL, CSA	(V)	600
Rated Operational Voltage U_e	IEC, VDE 0660	(V)	690
	UL, CSA	(V)	600
Rated Thermal Current I_{th} ($\theta \leq 55^\circ\text{C}$)		(A)	10
Rated Operational Current I_e			
AC-15 (IEC 60947-5-1)	$U_e \leq 240\text{V}$	(A)	10
	380–400 V	(A)	6
	415–440 V	(A)	6
	500V	(A)	4
	660–690 V	(A)	2
UL/CSA			A600
DC-13 (IEC 60947-5-1)	24V	(A)	6
	60V	(A)	2
	110V	(A)	1
	220–240 V	(A)	0.3
UL/CSA			Q600
Making Capacity (rms)	U_e 400 V 50/60 Hz - AC-15	(A)	$10 \times I_e$ (AC-15)
Breaking Capacity (rms)	U_e 400 V 50/60 Hz - AC-15	(A)	$10 \times I_e$ (AC-15)
Maximum IEC Fuse Class gL/gG Without Welding (Short-Circuit Protection) gL/gG		(A)	10
Control Circuit Reliability		(V/mA)	17 / 5
Electrical Endurance	(Millions operations)		1
Mechanical Endurance	(Millions operations)		10



CWC Series Miniature Contactors Electrical Durability

AC-3 ($U_e \leq 440VAC$)

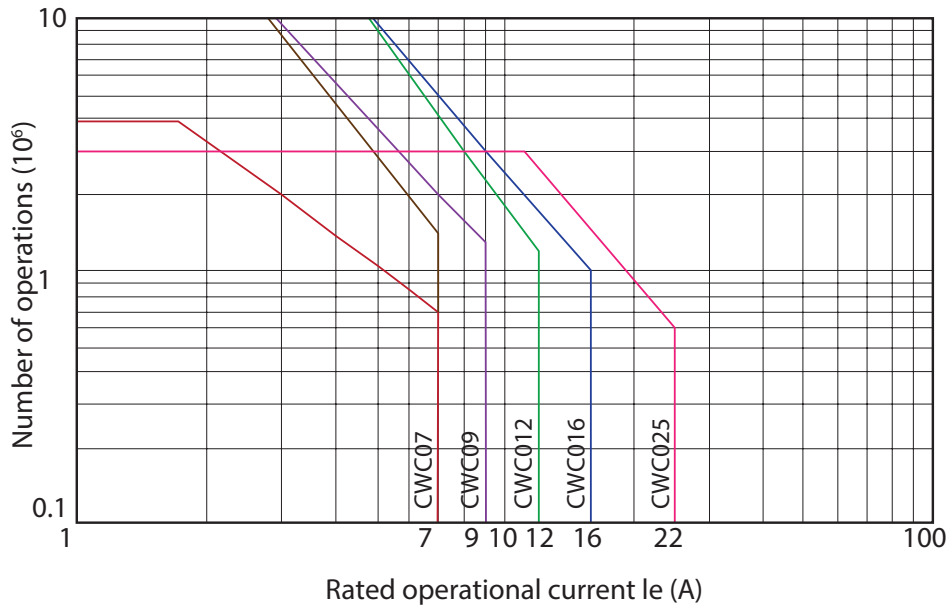

AC-4 ($U_e \leq 440VAC$)

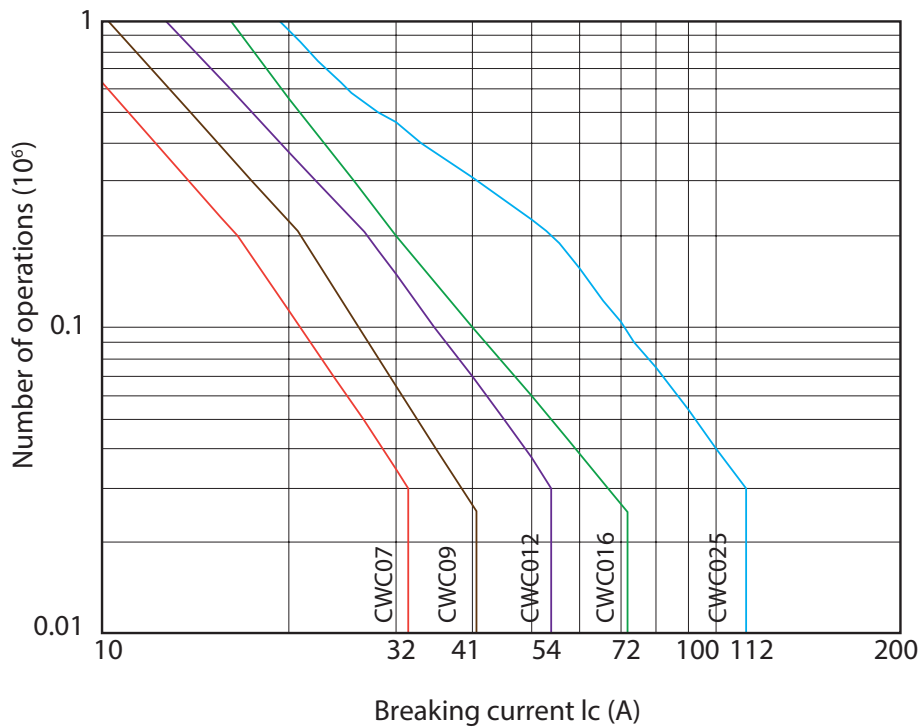

CWC Series Miniature Contactors Dimensions

Dimensions

mm [inches]

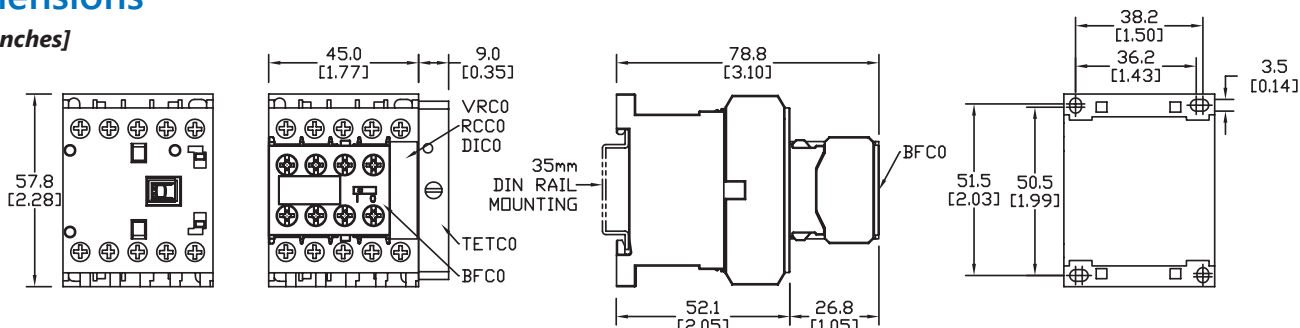

CWC07, CWC09, CWC012, CWC016 + VRC0/RCC0/DIC0

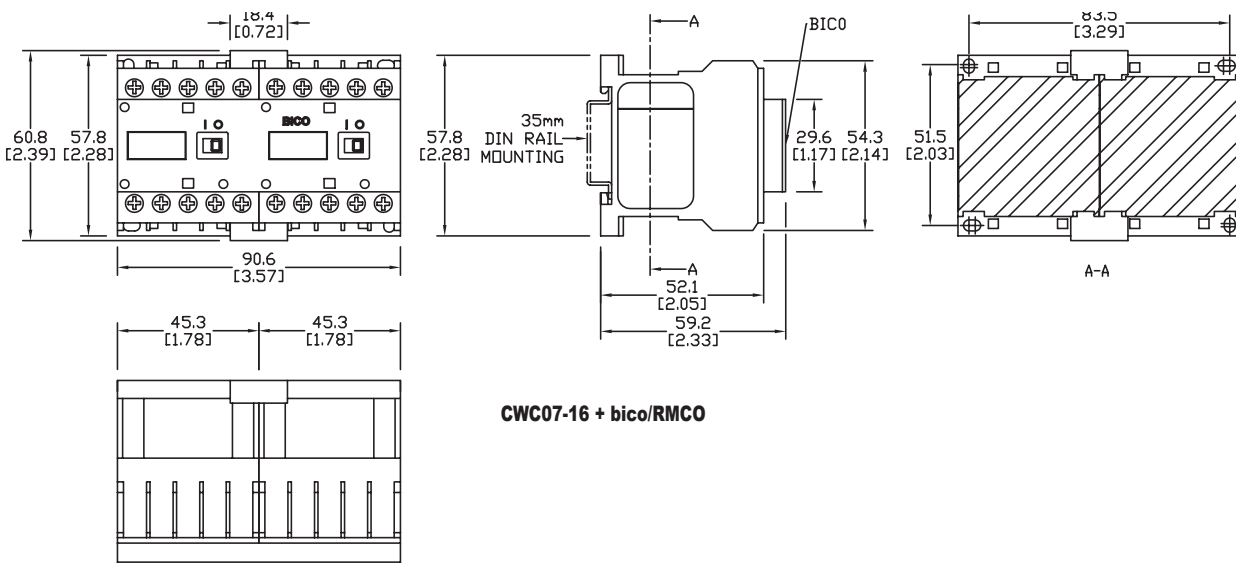

CWC07-16 + bico/RMCO

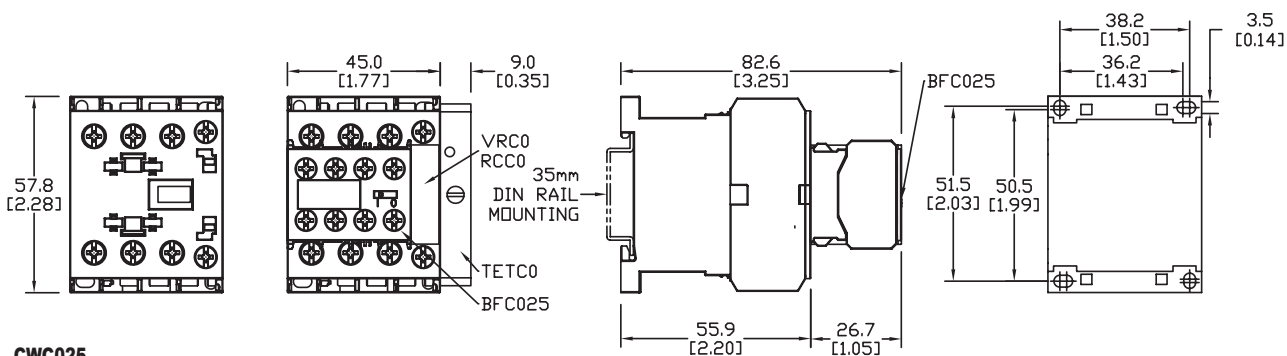

CWC025

Mounting position for CWC miniature contactors

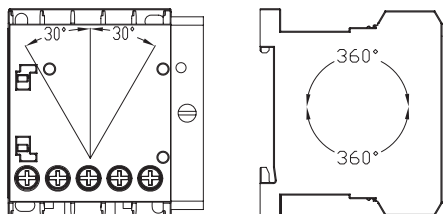



CWC Series Miniature Contactors

Accessories

Front Mounting Auxiliary Contact Blocks

Auxiliary Contact Blocks													
Use With	2 Maximum # of Contacts				Price	Use With	2 Maximum # of Contacts				Price		
	Auxiliary Contacts N.O.	N.C.	Terminal Markings	Part Number			Auxiliary Contacts N.O.	N.C.	Terminal Markings	Part Number			
Three-Pole Contactors (CWC07, CWC09, CWC012, CWC016)	2	0		BFC0-20*	\$5.00	Four-Pole Contactors (CWC07, CWC09, CWC016)	2	0		BFC4-20*	\$5.00		
	1	1		BFC0-11*	\$5.00		1	1		BFC4-11*	\$5.00		
	0	2		BFC0-02*	\$5.00		0	2		BFC4-02*	\$5.00		
	4 Maximum # of Contacts				Price		4 Maximum # of Contacts				Price		
	4	0		BFC0-40			\$8.00	4	0			BFC4-40	\$8.00
	2	2		BFC0-22			\$8.00	2	2			BFC4-22	\$8.00
	0	4		BFC0-04			\$8.25	0	4			BFC4-04	\$8.00
	3	1		BFC0-31			\$8.00	3	1			BFC4-31	\$8.00
	1	3		BFC0-13			\$8.00	1	3			BFC4-13	\$8.00
	Three-Pole Contactors CWC025	2 Maximum # of Contacts					Price	*Note: Low consumption 12VDC and 24VDC contactors can only use 2-pole auxiliary contact blocks					
2		0		BFC025-20	\$5.00	 BFC0-11							
1		1		BFC025-11	\$5.00								
0		2		BFC025-02	\$5.00								

CWC Series Miniature Contactors Accessories

Auxiliary Contact Blocks Technical Specifications

Auxiliary Contacts BFC0/BFC4/BFC025 Technical Specifications			
Standards	IEC 60947-5-1, IEC 60947-4-1		
Rated Insulation Voltage U_i (Pollution Degree 3)	IEC, VDE 0660	(V)	1000
	UL, CSA	(V)	600
Rated Operational Voltage U_e	IEC, VDE 0660	(V)	690
	UL, CSA	(V)	600
Rated Thermal Current I_{th} ($\theta \leq 55^\circ\text{C}$)		(A)	10
Making Capacity (rms)	U_e 400V 50/60 Hz - AC-15	(A)	30
Breaking Capacity (rms)	U_e 400V 50/60 Hz - AC-15	(A)	3
Maximum IEC Fuse Class gL/gG Without Welding (Short-Circuit Protection)		(A)	10
Minimum Switching Capacity		(V/mA)	17 / 5
Electrical Endurance	(Millions operations)		1
Mechanical Endurance	(Millions operations)		10

AC Auxiliary Contact Block Ratings UL/CSA

Contact Rating Code Designation	Thermal Continuous Current (A)	Maximum Current (A)								Maximum Apparent Power (VA)	
		120V		240V		480V		600V		Make	Break
		Make	Break	Make	Break	Make	Break	Make	Break		
A600	10	60	6	30	3	15	1.5	12	1.2	7200	720
C600	2.5	15	1.5	7.5	0.75	3.75	0.375	3	0.3	1800	180

DC Auxiliary Contact Block Ratings UL/CSA

Contact Rating Code Designation	Thermal Continuous Current (A)	Maximum Make or Break Current (A)		Maximum Make or Break Apparent Power (VA)
		125V	250V	
Q600	2.5	0.55	0.27	69
R300	1	0.22	0.11	28

Terminals Capacity and Tightening Torque – Power, Control Circuits, and Auxiliary Contact Blocks

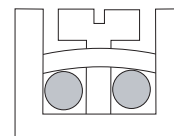

Terminals Capacity and Tightening Torque - Power, Control Circuits and Auxiliary Contact Blocks

Terminal Type		CWC07...16		CWC025		BFC0/BFC4/BFC025
		Main Contacts	Auxiliary Contacts	Main Contacts	Auxiliary Contacts	Auxiliary Contacts
Solid Cable	mm ²	1x 0.5–2.5	2x 0.5–2.5	1x 0.5–2.5	2x 0.5–2.5 1x 4	–
		2x 0.5–2.5		–		
Cable Without Ferrule	mm ²	1x 0.75–2.5	2x 0.5–2.6	2x 1–2.5	1x 0.75–2.5 2x 0.75–2.5	1x 0.75–4
		2x 0.75–2.5		2x 2.5–6		2x 0.75–2.5
Cable With Ferrule	mm ²	1x 2.5	–	2x 1–2.5	1x 0.5–2.5 2x 0.5–2.5	1x 0.5–4
		2x 2.5		2x 2.5–6		2x 0.5–2.5
Wire Gauge	AWG	1 or 2x 18–12	22–14	1 or 2x 18–10	22–14	22–14
Terminal Screws		M3 flat/philips	M3.5 flat/philips	M3 flat/philips	M3.5 flat/philips	M3.5 flat/philips
Tightening Torque	N·m [lb·in]	1–1.5 [8.85–13.28]	1–1.7 [8.85–15.05]	1.4–1.7 [12.39–15.05]	1–1.5 [8.85–13.28]	0.8–1.5 [7.08–13.28]

WEG CWC Series Miniature Contactors Accessories

Surge Suppressors

Surge Suppressors						
Part Number	Price	Circuit Diagram	Voltage	Max. Clamping Voltage @ Current (Ip)	For Use With	
RCC0-1D49	\$4.25		12-24 VAC 50/60 Hz	N/A	RC Resistor/ Capacitor AC Loads (The capacitor is used to absorb the voltage spike)	CWC07 CWC09 CWC012 CWC016 CWC025
RCC0-2D53	\$4.25		24-48 VAC 50/60 Hz			
RCC0-3D55	\$4.25		50-127 VAC 50/60 Hz			
RCC0-4D63	\$4.25		130-250 VAC 50/60 Hz			
RCC0-5D84	\$4.25		275-380 VAC 50/60 Hz			
RCC0-6D73	\$4.25		400-510 VAC 50/60 Hz			
VRC0-1E49	\$4.25		12-48 VAC 50/60 Hz / 12-60 VDC	135V @ 10A	MOV Varistor AC or DC Loads The voltage surge is limited to 3 times the voltage rating of the suppressor (300% of the rated coil voltage). Clamps voltage	CWC07 CWC09 CWC012 CWC016 CWC025
VRC0-2E34	\$4.25		50-127 VAC 50/60 Hz / 60-180 VDC	395V @ 10A		
VRC0-3E50	\$4.25		130-250 VAC 50/60 Hz / 180-300 VDC	710V @ 10A		
VRC0-5D73	Retired		400-510 VAC 50/60 Hz	775V @ 10A		
DIC0-1C33	\$4.25		12-600 VDC (1N4007)	N/A	Diode DC Loads The diode allows the remanent current to flow from a DC coil very smoothly and avoids an increase in voltage through the coil. Flyback suppression	CWC07 CWC09 CWC012 CWC016

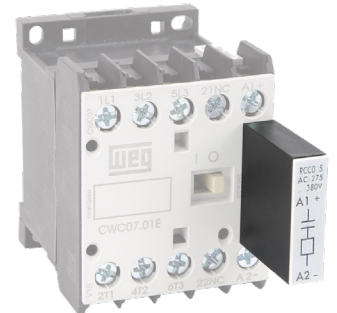

RCC0-5D84

Electronic Timing Relays

(CWC07...CWC025)

Star-Delta (TETCO) with LED Status Indication				
Part Number	Price	Voltage	Timing	Function
TETCO-U030S-D52	\$41.50	24-28 VDC 50/60 Hz	3 to 30 seconds	Star-Delta
TETCO-U030S-D61	\$41.50	110-130 VDC 50/60 Hz		
TETCO-U030S-D66	Retired	220-240 VDC 50/60 Hz		



TETCO-U030S-xxx

Note: Right side mounting

Timing Diagram

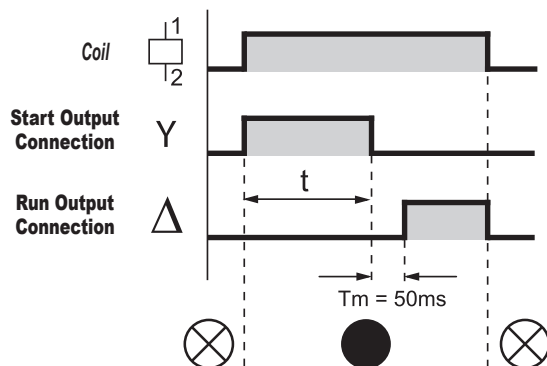

LED Off
 LED On
 Tm = Change over time

IEC Wiring Diagram

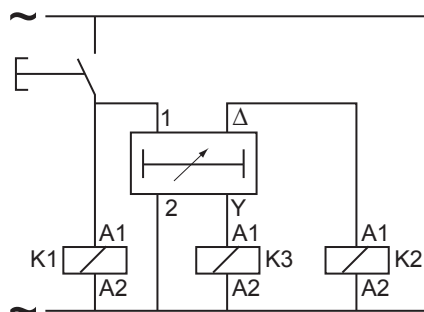

IEC Schematic Symbols	
	Timing Relay Coil
	Contactor/Control Relay Coil
	Push Button N.O. Contacts

WEG CWC Series Miniature Contactors Accessories

Wiring Kits (Jumper Assemblies)

- Quick and easy assembly for wye-delta and reversing starters
- Allows assembly of WEG overload relay RW17D

Reversing Wiring Kit for Mini Contactors CWC07 to CWC016										
PartNumber	Price	Max Rated Operational Power of Three-Phase Motors 50/60 Hz kW [hp]						Rated Operational Current I_e AC-3 ($U_e \leq 440V$)	Mini Contactors	
		220V 230V	380V	400V 415V	440V	500V	660V 690V		K1 = K2	
ECC0-R	\$11.00	1.5 [2]	3 [4]	3 [4]	3.7 [5]	3.7 [5]	3 [4]	7	CWC07	
		2.2 [3]	4 [5.4]	4 [5.4]	4.5 [6]	4.5 [6]	4 [5.4]	9	CWC09	
		3 [4]	5.5 [7.5]	5.5 [7.5]	5.5 [7.5]	5.5 [7.5]	5.5 [7.5]	12	CWC012	
		4 [5.4]	7.5 [10]	7.5 [10]	7.5 [10]	7.5 [10]	7.5 [10]	16	CWC016	
Star-Delta Wiring Kit for Mini Contactors CWC07 to CWC016										
Part Number	Price	Max Rated Operational Power of Three-Phase Motors 50/60 Hz kW [hp]			Rated Operational Current I_e AC-3 ($U_e \leq 440V$)	Mini Contactors				
		220-230 V	400-415 V	660-690 V		K1 = K2	K3			
ECC0-SD	\$12.00	3.7 [5]	5.5 [7.5]	5.5 [7.5]	12	CWC07	CWC07			
		3.7 [5]	7.5 [10]	9.2 [12.5]	18	CWC012				
		5.5 [7.5]	11 [15]	15 [20]	25	CWC016	CWC09			

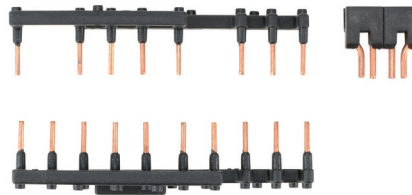
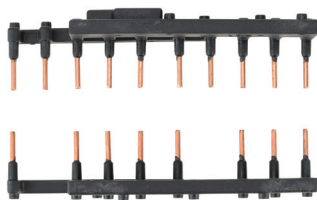

ECC0-R Wiring Diagram

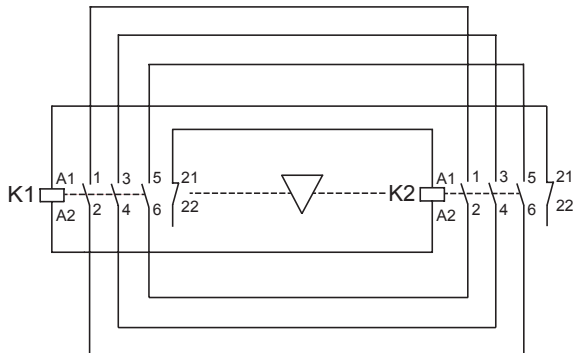

ECC0-SD Wiring Diagram

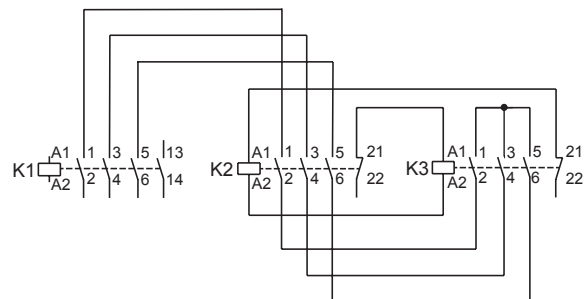



CWC Series Miniature Contactors Accessories

Mechanical Interlock Block and Latch Block

Mechanical Interlock Block and Latch Block			
Part Number	Price	Description	For Use With
BICO	\$3.50	Mechanical interlock, front mounted, use with any CWC07 through CWC016 series miniature contactor. Mechanically connects two CWC series mini contactors and prevents both contactors from being pulled in at the same time. For reversing contactors.	CWC07 CWC09 CWC012 CWC016
RMCO	\$4.00	Latch block, front mounted, use with any CWC07 through CWC016 series miniature contactor. Mechanically connects two CWC series mini contactors and enables one contactor to operate with a pulse input signal. Retention block for contactor.	



Note: Do not use BICO or RMCO accessory with mini contactors with low consumption DC coils.

Operation Description of Latched Block RMCO

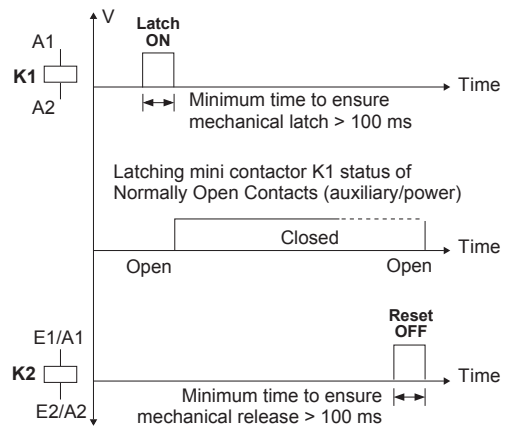
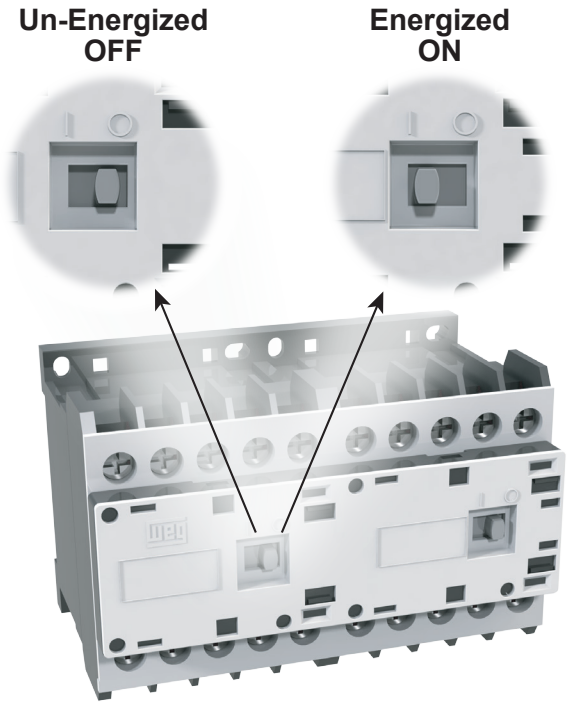
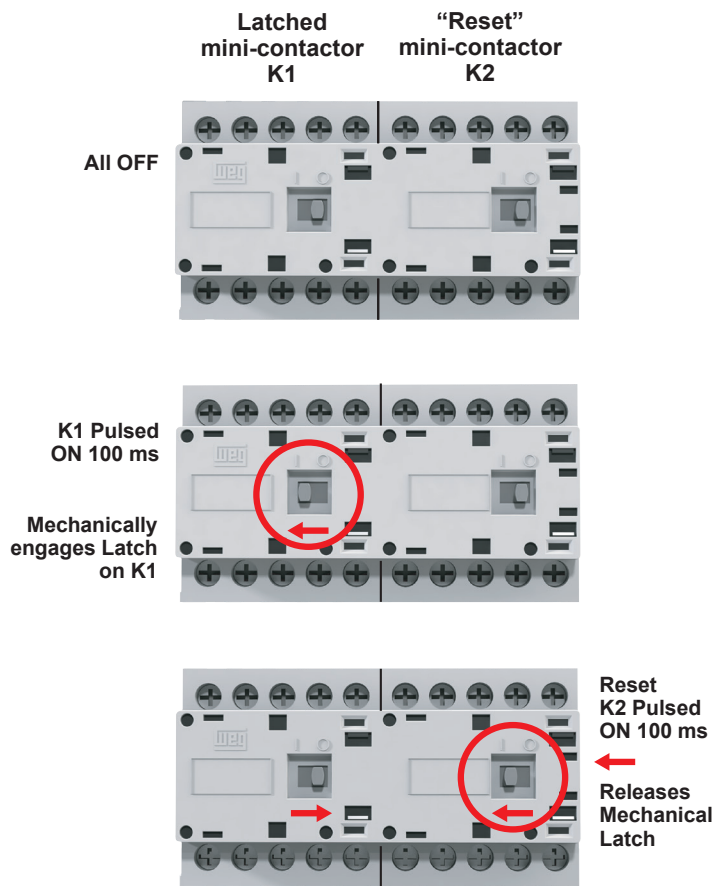

- After a minimum pulse of 100ms on mini contactor's coil (K1), the RMCO will keep K1 contactor switched on;
- The mini contactor K1 will only return to rest position after miniature contactor's coil (K2) has been energized by a releasing pulse of 100ms;
- The mechanical latch only occurs when mini contactor (K1) is energized (ON).

Note: If RESET miniature contactor's coil (K2) remains energized, the latching of mini contactor (K1) is not enabled.



CWC Series Miniature Contactors Accessories - Dimensions

Dimensions

mm [in]

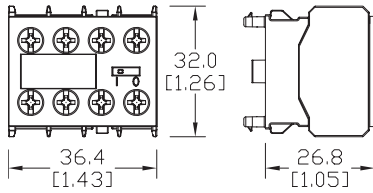

BFC0-xx, BFC4-xx, BFC025-xx

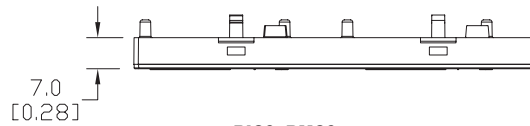
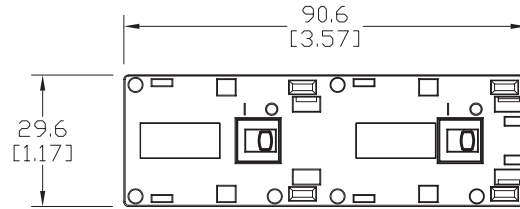

BICO, RMC0

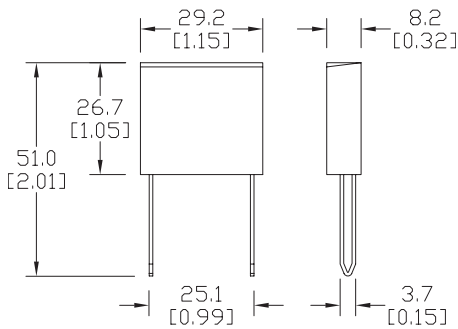

RCC0-xxxx, VRC0-xxxx, DIC0-xxxx

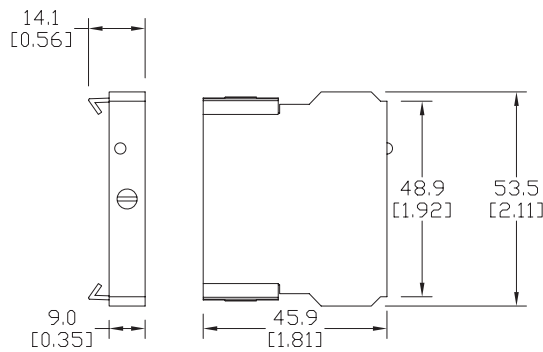

TETC0-U030S-Dxx