

# Safety Limit Switches Selection Guide



Series	HLM Series	HLM-SS Series	LSPS Series
<b>Prices start at</b>	<b>\$78.00</b>	<b>\$166.00</b>	<b>\$26.50</b>
<b>Description</b>	Die-cast metal body safety limit switch	Stainless steel body safety limit switch	Plastic body safety limit switch
<b>Material of Construction</b>	Die-cast zinc aluminum casing	Stainless steel 316 casing	Plastic casing
<b>Degree of Protection (IEC529)</b>	IEC IP67	IEC IP67/IP69	IEC IP67
<b>Maximum Switching Frequency</b>	6,000 operations/day	6,000 operations/day	6,000 operations/day
<b>Mechanical Service Life</b>	2,500,000 cycles	2,500,000 cycles	2,500,000 cycles
<b>Contact Configuration</b>	Each model available with: 2 N.C. / 2 N.O. slow action break before make contacts, or 1 N.O. / 1 N.C. snap action contacts	Each model available with: 2 N.C. / 2 N.O. slow action break before make contacts, or 1 N.O. / 1 N.C. snap action contacts	Each model available with: 2 N.C. / 2 N.O. slow action break before make contacts, or 1 N.O. / 1 N.C. snap action contacts
<b>Conduit Opening</b>	One cable hole	One cable hole	One cable hole
<b>Connection</b>	1/2 inch female NPT conduit	1/2 inch female NPT conduit	1/2 inch female NPT conduit
<b>Agency Approvals</b>	CE, UL (file E258676)	CE, UL (file E258676)	CE, UL (file E258676)



Series	LSMM Series	LSPM Series	AP2 Series
<b>Prices start at</b>	<b>\$48.00</b>	<b>\$36.00</b>	<b>\$15.50</b>
<b>Description</b>	Panel mount die-cast metal body safety limit switch	Panel mount plastic body safety limit switch	30 mm limit switches with pull button reset
<b>Material of Construction</b>	Die-cast zinc aluminum casing	Plastic casing	Plastic casing, double insulated
<b>Degree of Protection (IEC529)</b>	IEC IP67	IEC IP67	IEC IP65
<b>Maximum Switching Frequency</b>	6,000 operations/day	6,000 operations/day	Contact blocks: 1 cycle per second (all)
<b>Mechanical Service Life</b>	2,500,000 cycles	2,500,000 cycles	1,000,000 operations interlock and limit switches
<b>Contact Configuration</b>	Each model available with: 2 N.C. / 1 N.O. slow action break before make contacts, or 1 N.O. / 1 N.C. snap action contacts	Each model available with: 2 N.C. / 1 N.O. slow action break before make contacts, or 1 N.O. / 1 N.C. snap action contacts	X11 - Slow action break before make, positive opening, 1 N.O. + 1 N.C. W02 - Simultaneous, slow action, positive opening, 2 N.C.
<b>Conduit Opening</b>	One cable hole	One cable hole	One cable hole, 1/2" NPT adapter
<b>Connection</b>	Pigtail; 2m / 6.5 ft cable length	Pigtail; 2m / 6.5 ft cable length	2x2.5mm2 (AWG14) to 2x0.5mm2 (AWG 18)
<b>Agency Approvals</b>	CE, UL (file E258676)	CE, UL (file E258676)	CE, UL file E189258, CSA 176294, RoHS

# Comepi Safety Limit Switches

These safety limit switches are developed and manufactured according to IEC and EN European standards. Easy to use, electromechanical limit switches provide:

- Visible operation
- Ability to switch large currents (10 A conventional thermal current)

- Precise operating points (consistency)
- Immunity to electromagnetic disturbances
- Electrically separated contacts (Zb)
- N.C. contacts with positive opening operation  $\rightarrow$
- Conduit threads - 1/2" NPT adapter



AP2R Series Safety Limit Switches Selection Chart											
Part Number	Price	Actuator Type	No. of Conduit Holes	Max. Actuation Speed (m/s)	Min. Actuation Force (N) Torque(Nm)	Min. Positive Opening Force (N) Torque (Nm)	B10d	Head Dimensions	Contact Config. Diagram	Weight (lbs.)	Photo
<a href="#">AP2R11X11</a>	\$15.50	Steel plunger with reset	One	0.5	9N	44N	2,000,000 operations	Figure 1	1	0.2	A
<a href="#">AP2R11W02</a>	\$15.50		One					Figure 1	2	0.2	
<a href="#">AP2R13X11</a>	\$16.50	Steel plunger with nylon roller with reset	One	0.3	12N	44N		Figure 2	1	0.2	B
<a href="#">AP2R13W02</a>	\$16.50		One					Figure 2	2	0.2	
<a href="#">AP2R31X11</a>	\$17.00	Steel plunger with one-way horizontal actuated nylon roller with reset	One	1.0	7N	24N		Figure 3	1	0.2	C
<a href="#">AP2R31W02</a>	\$17.00		One					Figure 3	2	0.2	
<a href="#">AP2R32X11</a>	\$17.50	Steel plunger with one-way vertical actuated nylon roller with reset	One					Figure 4	1	0.2	D
<a href="#">AP2R32W02</a>	\$17.50		One					Figure 4	2	0.2	
<a href="#">AP2R41X11</a>	\$19.00	Lever with nylon roller with reset	One	1.5	0.10Nm	0.32Nm		Figure 5	1	0.2	E
<a href="#">AP2R41W02</a>	\$19.00		One					Figure 5	2	0.2	
<a href="#">AP2R51X11</a>	\$20.00	Adjustable lever with nylon roller with reset	One					Figure 6	1	0.2	F
<a href="#">AP2R51W02</a>	\$20.00		One					Figure 6	2	0.2	

## Dimensions

mm [in]

### AP2R Series Body

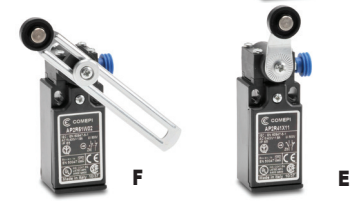
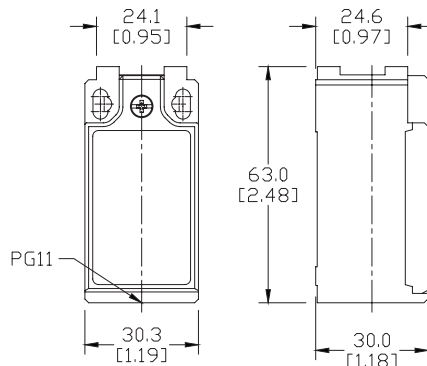

Figure 1

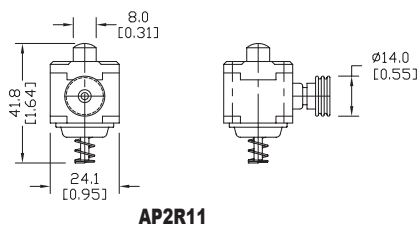

Figure 2

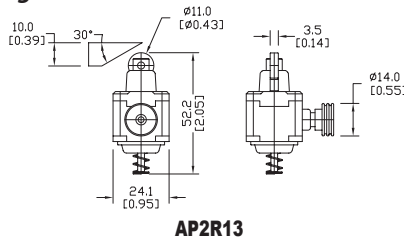

Figure 3

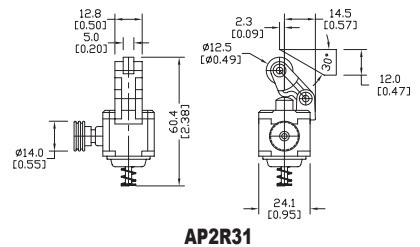

Figure 4

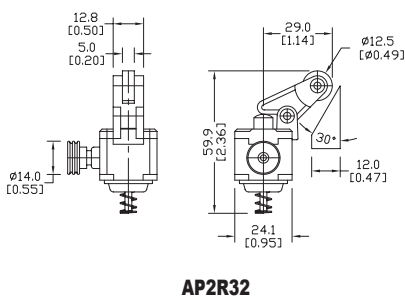

Figure 5

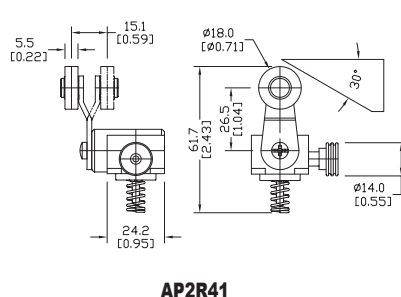
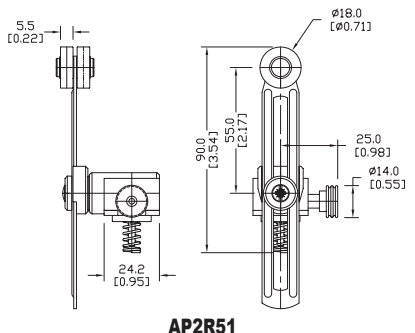

Figure 6



# Comepi Safety Limit Switches

## Contacts Configuration Charts

**Chart 1**

X11 Slow action break before make 1NO+1NC

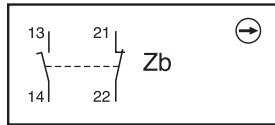

**Chart 2**

W02 Simultaneous slow action 2NC

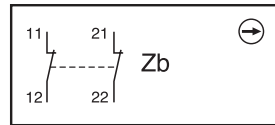

**Chart 3**

X12 Slow action break before make 1NO+2NC

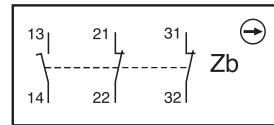

**Chart 4**

W03 Simultaneous slow action 3NC

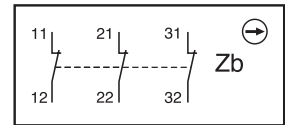

## Bar charts for keys, shaft lever or limit switches

**X11**

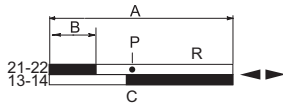

**W02**

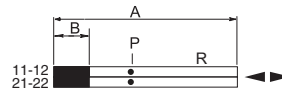

**X12**

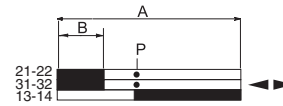

**W03**

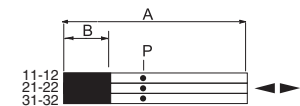

A = Max. travel of the operator in mm or degrees

B = Tripping travel of the N.C. contact

C = Tripping travel of the N.O. contact

P = Point from which positive opening is assured

R = Reset latch activates

□ = Contact open

■ = Contact closed

Part Series	Contact Configuration	Displacement Values mm[in] or degrees				
		A	B	C	P	R
AP2R11	X11	5.6 [0.22]	1.6 [0.06]	2.5 [0.10]	3.2 [0.13]	4.4 [0.17]
	W02	5.6 [0.22]	1.5 [0.06]	–	3.1 [0.12]	4.4 [0.17]
AP2R13	X11	9.6 [0.38]	3.2 [0.13]	4.6 [0.18]	6.0 [0.23]	7.5 [0.30]
	W02	9.6 [0.38]	3.0 [0.12]	–	5.9 [0.23]	7.5 [0.30]
AP2R31, AP2R32	X11	21.0 [0.83]	6.0 [0.24]	8.6 [0.34]	10.5 [0.41]	15.6 [0.61]
	W02	21.0 [0.83]	5.7 [0.22]	–	10.2 [0.40]	15.6 [0.61]
AP2R41, AP2R51	X11	±74°	±21°	±30°	±37°	±60°
	W02	±74°	±19°	–	±37°	±60°

# Comepi Safety Limit Switches

<b>Comepi Safety Limit Switches Specifications</b>	
<b>Safety Characteristic Data</b>	
<b>Performance level</b>	Up to PLe depending on the system architecture
<b>Category</b>	Up to Cat 4 depending on the system architecture
<b>Safety Integrity Level</b>	Up to SIL3 depending on the system architecture
<b>B10d</b>	2 million operations
<b>Safety Data - Annual Usage</b>	8 cycles per hour / 24 hours per day / 365 days
<b>MTTFd</b>	285 years
<b>PFHd (1/h)</b>	$4.01 \times 10^{-7}$
<b>Proof Test Interval T1</b>	Minimum 8,760 hours (depending on site test frequency)
<b>Electrical and General Specifications</b>	
<b>Utilization Category</b>	AC15 - DC13 / A600 - B600
<b>Minimum Switched Current</b>	5mA, 5VDC
<b>Thermal Current</b>	10A
<b>Rated Insulation Voltage</b>	500V
<b>Max. Switching Speed</b>	R11: 0.3m/s - R13: 0.3m/s - R31/R32: 1m/s - R41/R51: 1.5m/s
<b>Max. Switching Frequency</b>	3,600 operations/hour
<b>Case Material</b>	Thermoplastic
<b>Operating Temperature</b>	-25° to +70°C [-13° to +158°F]
<b>Enclosure Protection</b>	IP65
<b>Mechanical Life Expectancy</b>	1 million operations
<b>Vibration</b>	According to EN 60068-2-6
<b>Conductor Size</b>	0.75 to 2.5 mm <sup>2</sup>
<b>Recommended Head Screws Torque</b>	0.5 Nm recommended / 0.8 Nm maximum
<b>Recommended Lid Screws Torque</b>	0.5 Nm recommended / 0.8 Nm maximum
<b>Recommended Mounting Bolt Torque</b>	1 Nm
<b>Recommended Mounting Screws</b>	M4
<b>Agency Approvals</b>	CE - cULus - IMQ - CCC - EAC

# Safety Products



*Warning: Safety products sold by AutomationDirect are Safety components only. The purchaser/installer is solely responsible for the application of these components and ensuring all necessary steps have been taken to assure each application and use meets all performance and applicable safety requirements and/or local, national and/or international safety codes as required by the application. AutomationDirect cannot certify that our products, used solely or in conjunction with other AutomationDirect or other vendors' products, will assure safety for any application. Any person using or applying any products sold by AutomationDirect is responsible for learning the safety requirements for their individual application and applying them, and therefore assumes all risks, and accepts full and complete responsibility, for the selection and suitability of the product for their respective application.*

*AutomationDirect does not provide design or consulting services, and cannot advise whether any specific application or use of our products would ensure compliance with the safety requirements for any application.*