

Safety Limit Switches Selection Guide



| Series | HLM Series | HLM-SS Series | LSPS Series |
|--------------------------------------|--|--|--|
| Prices start at | \$78.00 | \$166.00 | \$26.50 |
| Description | Die-cast metal body safety limit switch | Stainless steel body safety limit switch | Plastic body safety limit switch |
| Material of Construction | Die-cast zinc aluminum casing | Stainless steel 316 casing | Plastic casing |
| Degree of Protection (IEC529) | IEC IP67 | IEC IP67/IP69 | IEC IP67 |
| Maximum Switching Frequency | 6,000 operations/day | 6,000 operations/day | 6,000 operations/day |
| Mechanical Service Life | 2,500,000 cycles | 2,500,000 cycles | 2,500,000 cycles |
| Contact Configuration | Each model available with: 2 N.C. / 2 N.O. slow action break before make contacts, or 1 N.O. / 1 N.C. snap action contacts | Each model available with: 2 N.C. / 2 N.O. slow action break before make contacts, or 1 N.O. / 1 N.C. snap action contacts | Each model available with: 2 N.C. / 2 N.O. slow action break before make contacts, or 1 N.O. / 1 N.C. snap action contacts |
| Conduit Opening | One cable hole | One cable hole | One cable hole |
| Connection | 1/2 inch female NPT conduit | 1/2 inch female NPT conduit | 1/2 inch female NPT conduit |
| Agency Approvals | CE, UL (file E258676) | CE, UL (file E258676) | CE, UL (file E258676) |



| Series | LSMM Series | LSPM Series | AP2 Series |
|--------------------------------------|--|--|---|
| Prices start at | \$48.00 | \$36.00 | \$15.50 |
| Description | Panel mount die-cast metal body safety limit switch | Panel mount plastic body safety limit switch | 30 mm limit switches with pull button reset |
| Material of Construction | Die-cast zinc aluminum casing | Plastic casing | Plastic casing, double insulated |
| Degree of Protection (IEC529) | IEC IP67 | IEC IP67 | IEC IP65 |
| Maximum Switching Frequency | 6,000 operations/day | 6,000 operations/day | Contact blocks: 1 cycle per second (all) |
| Mechanical Service Life | 2,500,000 cycles | 2,500,000 cycles | 1,000,000 operations interlock and limit switches |
| Contact Configuration | Each model available with: 2 N.C. / 1 N.O. slow action break before make contacts, or 1 N.O. / 1 N.C. snap action contacts | Each model available with: 2 N.C. / 1 N.O. slow action break before make contacts, or 1 N.O. / 1 N.C. snap action contacts | X11 - Slow action break before make, positive opening, 1 N.O. + 1 N.C. W02 - Simultaneous, slow action, positive opening, 2 N.C. |
| Conduit Opening | One cable hole | One cable hole | One cable hole, 1/2" NPT adapter |
| Connection | Pigtail; 2m / 6.5 ft cable length | Pigtail; 2m / 6.5 ft cable length | 2x2.5mm2 (AWG14) to 2x0.5mm2 (AWG 18) |
| Agency Approvals | CE, UL (file E258676) | CE, UL (file E258676) | CE, UL file E189258, CSA 176294, RoHS |

Comepi Safety Limit Switches

These safety limit switches are developed and manufactured according to IEC and EN European standards. Easy to use, electromechanical limit switches provide:

- Visible operation
- Ability to switch large currents (10 A conventional thermal current)

- Precise operating points (consistency)
- Immunity to electromagnetic disturbances
- Electrically separated contacts (Zb)
- N.C. contacts with positive opening operation \rightarrow
- Conduit threads - 1/2" NPT adapter



| AP2R Series Safety Limit Switches Selection Chart | | | | | | | | | | | | | | |
|---|---------|--|----------------------|----------------------------|-------------------------------------|---|----------------------|-----------------|-------------------------|---------------|----------|---|-----|---|
| Part Number | Price | Actuator Type | No. of Conduit Holes | Max. Actuation Speed (m/s) | Min. Actuation Force (N) Torque(Nm) | Min. Positive Opening Force (N) Torque (Nm) | B10d | Head Dimensions | Contact Config. Diagram | Weight (lbs.) | Photo | | | |
| AP2R11X11 | \$15.50 | Steel plunger with reset | One | 0.5 | 9N | 44N | 2,000,000 operations | Figure 1 | 1 | 0.2 | A | | | |
| AP2R11W02 | \$15.50 | | One | | | | | Figure 1 | 2 | 0.2 | | | | |
| AP2R13X11 | \$16.50 | Steel plunger with nylon roller with reset | One | 0.3 | 12N | 44N | | Figure 2 | 1 | 0.2 | B | | | |
| AP2R13W02 | \$16.50 | | One | | | | | Figure 2 | 2 | 0.2 | | | | |
| AP2R31X11 | \$17.00 | Steel plunger with one-way horizontal actuated nylon roller with reset | One | 1.0 | 7N | 24N | | Figure 3 | 1 | 0.2 | C | | | |
| AP2R31W02 | \$17.00 | | One | | | | | Figure 3 | 2 | 0.2 | | | | |
| AP2R32X11 | \$17.50 | Steel plunger with one-way vertical actuated nylon roller with reset | One | | | | | Figure 4 | 1 | 0.2 | D | | | |
| AP2R32W02 | \$17.50 | | One | | | | | Figure 4 | 2 | 0.2 | | | | |
| AP2R41X11 | \$19.00 | Lever with nylon roller with reset | One | | | | | 1.5 | 0.10Nm | 0.32Nm | Figure 5 | 1 | 0.2 | E |
| AP2R41W02 | \$19.00 | | One | | | | | | | | Figure 5 | 2 | 0.2 | |
| AP2R51X11 | \$20.00 | Adjustable lever with nylon roller with reset | One | Figure 6 | 1 | 0.2 | | | | | F | | | |
| AP2R51W02 | \$20.00 | | One | Figure 6 | 2 | 0.2 | | | | | | | | |

Dimensions

mm [in]

AP2R Series Body

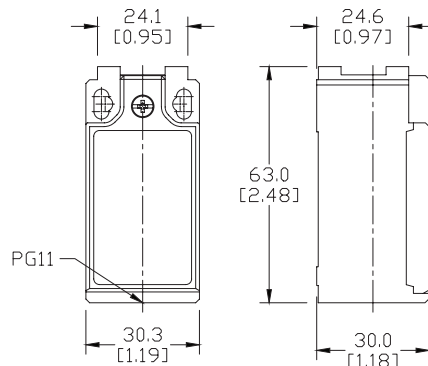

F

Figure 1

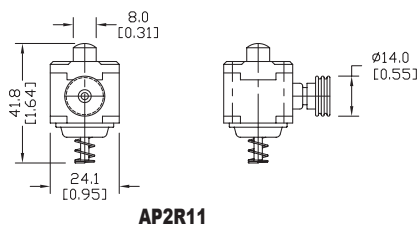

AP2R11

Figure 2

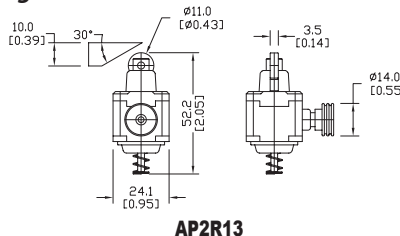

AP2R13

Figure 3

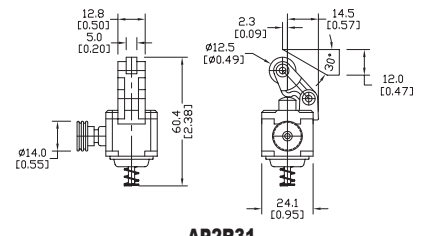

AP2R31

Figure 4

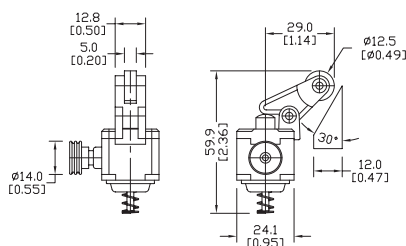

AP2R32

Figure 5

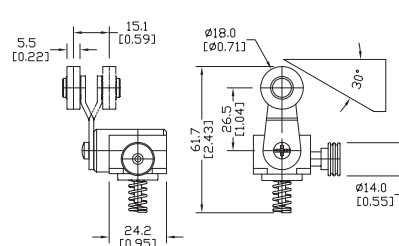

AP2R41

Figure 6

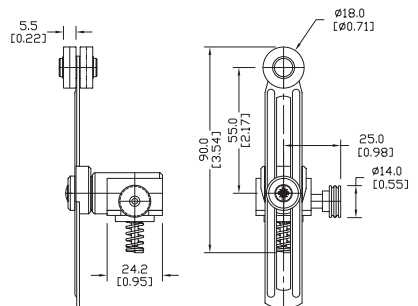

AP2R51

Comepi Safety Limit Switches

Contacts Configuration Charts

Chart 1

X11 Slow action break before make 1NO+1NC

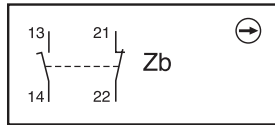

Chart 2

W02 Simultaneous slow action 2NC

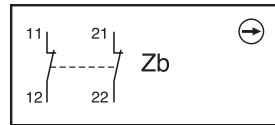

Chart 3

X12 Slow action break before make 1NO+2NC

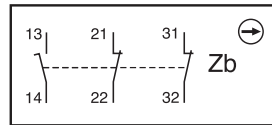
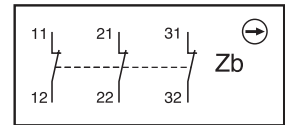

Chart 4

W03 Simultaneous slow action 3NC



Bar charts for keys, shaft lever or limit switches

X11

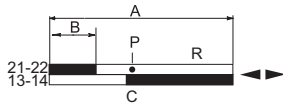

W02

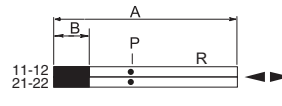

X12

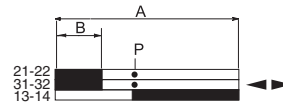

W03

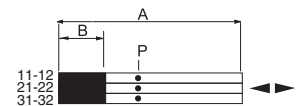

A = Max. travel of the operator in mm or degrees

B = Tripping travel of the N.C. contact

C = Tripping travel of the N.O. contact

P = Point from which positive opening is assured

R = Reset latch activates

□ = Contact open

■ = Contact closed

| Part Series | Contact Configuration | Displacement Values mm[in] or degrees | | | | |
|----------------|-----------------------|---------------------------------------|------------|------------|-------------|-------------|
| | | A | B | C | P | R |
| AP2R11 | X11 | 5.6 [0.22] | 1.6 [0.06] | 2.5 [0.10] | 3.2 [0.13] | 4.4 [0.17] |
| | W02 | 5.6 [0.22] | 1.5 [0.06] | – | 3.1 [0.12] | 4.4 [0.17] |
| AP2R13 | X11 | 9.6 [0.38] | 3.2 [0.13] | 4.6 [0.18] | 6.0 [0.23] | 7.5 [0.30] |
| | W02 | 9.6 [0.38] | 3.0 [0.12] | – | 5.9 [0.23] | 7.5 [0.30] |
| AP2R31, AP2R32 | X11 | 21.0 [0.83] | 6.0 [0.24] | 8.6 [0.34] | 10.5 [0.41] | 15.6 [0.61] |
| | W02 | 21.0 [0.83] | 5.7 [0.22] | – | 10.2 [0.40] | 15.6 [0.61] |
| AP2R41, AP2R51 | X11 | ±74° | ±21° | ±30° | ±37° | ±60° |
| | W02 | ±74° | ±19° | – | ±37° | ±60° |

Comepi Safety Limit Switches

| Comepi Safety Limit Switches Specifications | |
|--|---|
| Safety Characteristic Data | |
| Performance level | Up to PLe depending on the system architecture |
| Category | Up to Cat 4 depending on the system architecture |
| Safety Integrity Level | Up to SIL3 depending on the system architecture |
| B10d | 2 million operations |
| Safety Data - Annual Usage | 8 cycles per hour / 24 hours per day / 365 days |
| MTTFd | 285 years |
| PFHd (1/h) | 4.01×10^{-7} |
| Proof Test Interval T1 | Minimum 8,760 hours (depending on site test frequency) |
| Electrical and General Specifications | |
| Utilization Category | AC15 - DC13 / A600 - B600 |
| Minimum Switched Current | 5mA, 5VDC |
| Thermal Current | 10A |
| Rated Insulation Voltage | 500V |
| Max. Switching Speed | R11: 0.3m/s - R13: 0.3m/s - R31/R32: 1m/s - R41/R51: 1.5m/s |
| Max. Switching Frequency | 3,600 operations/hour |
| Case Material | Thermoplastic |
| Operating Temperature | -25° to +70°C [-13° to +158°F] |
| Enclosure Protection | IP65 |
| Mechanical Life Expectancy | 1 million operations |
| Vibration | According to EN 60068-2-6 |
| Conductor Size | 0.75 to 2.5 mm ² |
| Recommended Head Screws Torque | 0.5 Nm recommended / 0.8 Nm maximum |
| Recommended Lid Screws Torque | 0.5 Nm recommended / 0.8 Nm maximum |
| Recommended Mounting Bolt Torque | 1 Nm |
| Recommended Mounting Screws | M4 |
| Agency Approvals | CE - cULus - IMQ - CCC - EAC |

Safety Products



Warning: Safety products sold by AutomationDirect are Safety components only. The purchaser/installer is solely responsible for the application of these components and ensuring all necessary steps have been taken to assure each application and use meets all performance and applicable safety requirements and/or local, national and/or international safety codes as required by the application. AutomationDirect cannot certify that our products, used solely or in conjunction with other AutomationDirect or other vendors' products, will assure safety for any application. Any person using or applying any products sold by AutomationDirect is responsible for learning the safety requirements for their individual application and applying them, and therefore assumes all risks, and accepts full and complete responsibility, for the selection and suitability of the product for their respective application.

AutomationDirect does not provide design or consulting services, and cannot advise whether any specific application or use of our products would ensure compliance with the safety requirements for any application.