

Safety Limit Switches Selection Guide



Series	HLM Series	HLM-SS Series	LSPS Series
Prices start at	\$78.00	\$166.00	\$26.50
Description	Die-cast metal body safety limit switch	Stainless steel body safety limit switch	Plastic body safety limit switch
Material of Construction	Die-cast zinc aluminum casing	Stainless steel 316 casing	Plastic casing
Degree of Protection (IEC529)	IEC IP67	IEC IP67/IP69	IEC IP67
Maximum Switching Frequency	6,000 operations/day	6,000 operations/day	6,000 operations/day
Mechanical Service Life	2,500,000 cycles	2,500,000 cycles	2,500,000 cycles
Contact Configuration	Each model available with: 2 N.C. / 2 N.O. slow action break before make contacts, or 1 N.O. / 1 N.C. snap action contacts	Each model available with: 2 N.C. / 2 N.O. slow action break before make contacts, or 1 N.O. / 1 N.C. snap action contacts	Each model available with: 2 N.C. / 2 N.O. slow action break before make contacts, or 1 N.O. / 1 N.C. snap action contacts
Conduit Opening	One cable hole	One cable hole	One cable hole
Connection	1/2 inch female NPT conduit	1/2 inch female NPT conduit	1/2 inch female NPT conduit
Agency Approvals	CE, UL (file E258676)	CE, UL (file E258676)	CE, UL (file E258676)



Series	LSMM Series	LSPM Series	AP2 Series
Prices start at	\$48.00	\$36.00	\$15.50
Description	Panel mount die-cast metal body safety limit switch	Panel mount plastic body safety limit switch	30 mm limit switches with pull button reset
Material of Construction	Die-cast zinc aluminum casing	Plastic casing	Plastic casing, double insulated
Degree of Protection (IEC529)	IEC IP67	IEC IP67	IEC IP65
Maximum Switching Frequency	6,000 operations/day	6,000 operations/day	Contact blocks: 1 cycle per second (all)
Mechanical Service Life	2,500,000 cycles	2,500,000 cycles	1,000,000 operations interlock and limit switches
Contact Configuration	Each model available with: 2 N.C. / 1 N.O. slow action break before make contacts, or 1 N.O. / 1 N.C. snap action contacts	Each model available with: 2 N.C. / 1 N.O. slow action break before make contacts, or 1 N.O. / 1 N.C. snap action contacts	X11 - Slow action break before make, positive opening, 1 N.O. + 1 N.C. W02 - Simultaneous, slow action, positive opening, 2 N.C.
Conduit Opening	One cable hole	One cable hole	One cable hole, 1/2" NPT adapter
Connection	Pigtail; 2m / 6.5 ft cable length	Pigtail; 2m / 6.5 ft cable length	2x2.5mm2 (AWG14) to 2x0.5mm2 (AWG 18)
Agency Approvals	CE, UL (file E258676)	CE, UL (file E258676)	CE, UL file E189258, CSA 176294, RoHS

Comepi Safety Limit Switches

These safety limit switches are developed and manufactured according to IEC and EN European standards. Easy to use, electromechanical limit switches provide:

- Visible operation
- Ability to switch large currents (10 A conventional thermal current)

- Precise operating points (consistency)
- Immunity to electromagnetic disturbances
- Electrically separated contacts (Zb)
- N.C. contacts with positive opening operation \rightarrow
- Conduit threads - 1/2" NPT adapter



A



B



C



D



E

AP2R Series Safety Limit Switches Selection Chart											
Part Number	Price	Actuator Type	No. of Conduit Holes	Max. Actuation Speed (m/s)	Min. Actuation Force (N) Torque(Nm)	Min. Positive Opening Force (N) Torque (Nm)	B10d	Head Dimensions	Contact Config. Diagram	Weight (lbs.)	Photo
AP2R11X11	\$15.50	Steel plunger with reset	One	0.5	9N	44N	2,000,000 operations	Figure 1	1	0.2	A
AP2R11W02	\$15.50		One					Figure 1	2	0.2	
AP2R13X11	\$16.50	Steel plunger with nylon roller with reset	One	0.3	12N	44N		Figure 2	1	0.2	B
AP2R13W02	\$16.50		One					Figure 2	2	0.2	
AP2R31X11	\$17.00	Steel plunger with one-way horizontal actuated nylon roller with reset	One	1.0	7N	24N		Figure 3	1	0.2	C
AP2R31W02	\$17.00		One					Figure 3	2	0.2	
AP2R32X11	\$17.50	Steel plunger with one-way vertical actuated nylon roller with reset	One					Figure 4	1	0.2	D
AP2R32W02	\$17.50		One					Figure 4	2	0.2	
AP2R41X11	\$19.00	Lever with nylon roller with reset	One	1.5	0.10Nm	0.32Nm		Figure 5	1	0.2	E
AP2R41W02	\$19.00		One					Figure 5	2	0.2	
AP2R51X11	\$20.00	Adjustable lever with nylon roller with reset	One					Figure 6	1	0.2	F
AP2R51W02	\$20.00		One					Figure 6	2	0.2	

Dimensions

mm [in]

AP2R Series Body

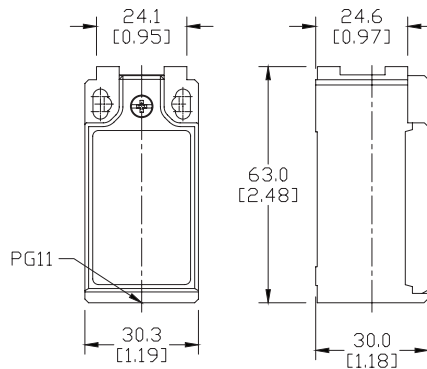

F



G

Figure 1

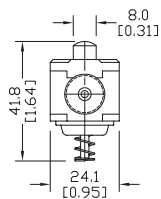

AP2R11

Figure 2

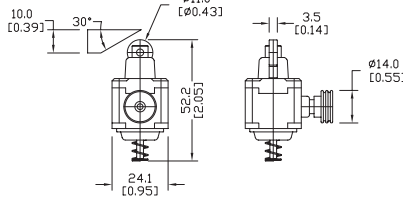

AP2R13

Figure 3

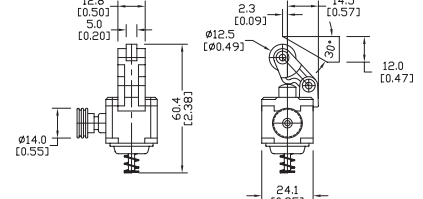

AP2R31

Figure 4

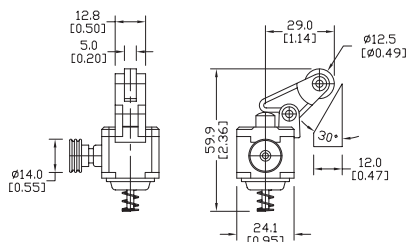

AP2R32

Figure 5

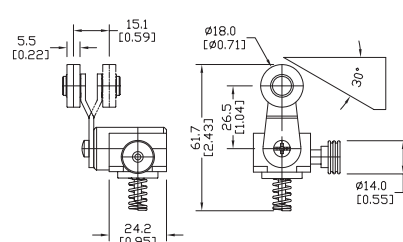

AP2R41

Figure 6

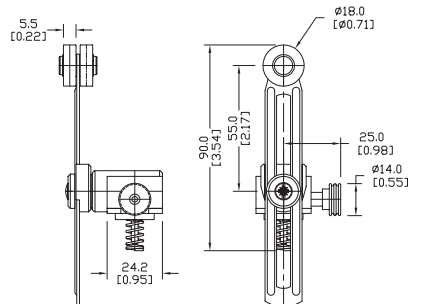

AP2R51

Comepi Safety Limit Switches

Contacts Configuration Charts

Chart 1

X11 Slow action break before make 1NO+1NC

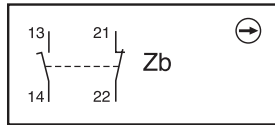

Chart 2

W02 Simultaneous slow action 2NC

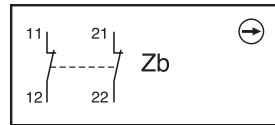

Chart 3

X12 Slow action break before make 1NO+2NC

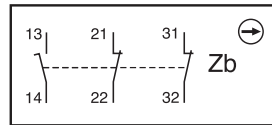
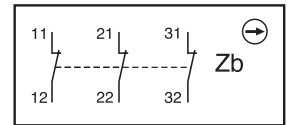

Chart 4

W03 Simultaneous slow action 3NC



Bar charts for keys, shaft lever or limit switches

X11

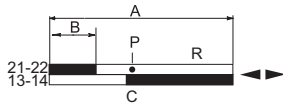

W02

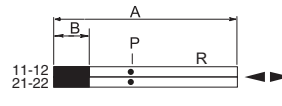

X12

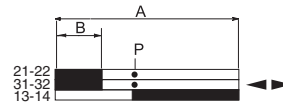

W03

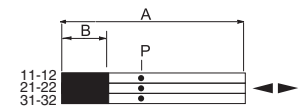

A = Max. travel of the operator in mm or degrees

B = Tripping travel of the N.C. contact

C = Tripping travel of the N.O. contact

P = Point from which positive opening is assured

R = Reset latch activates

□ = Contact open

■ = Contact closed

Part Series	Contact Configuration	Displacement Values mm[in] or degrees				
		A	B	C	P	R
AP2R11	X11	5.6 [0.22]	1.6 [0.06]	2.5 [0.10]	3.2 [0.13]	4.4 [0.17]
	W02	5.6 [0.22]	1.5 [0.06]	–	3.1 [0.12]	4.4 [0.17]
AP2R13	X11	9.6 [0.38]	3.2 [0.13]	4.6 [0.18]	6.0 [0.23]	7.5 [0.30]
	W02	9.6 [0.38]	3.0 [0.12]	–	5.9 [0.23]	7.5 [0.30]
AP2R31, AP2R32	X11	21.0 [0.83]	6.0 [0.24]	8.6 [0.34]	10.5 [0.41]	15.6 [0.61]
	W02	21.0 [0.83]	5.7 [0.22]	–	10.2 [0.40]	15.6 [0.61]
AP2R41, AP2R51	X11	±74°	±21°	±30°	±37°	±60°
	W02	±74°	±19°	–	±37°	±60°

Comepi Safety Limit Switches

Comepi Safety Limit Switches Specifications	
Safety Characteristic Data	
Performance level	Up to PLe depending on the system architecture
Category	Up to Cat 4 depending on the system architecture
Safety Integrity Level	Up to SIL3 depending on the system architecture
B10d	2 million operations
Safety Data - Annual Usage	8 cycles per hour / 24 hours per day / 365 days
MTTFd	285 years
PFHd (1/h)	4.01×10^{-7}
Proof Test Interval T1	Minimum 8,760 hours (depending on site test frequency)
Electrical and General Specifications	
Utilization Category	AC15 - DC13 / A600 - B600
Minimum Switched Current	5mA, 5VDC
Thermal Current	10A
Rated Insulation Voltage	500V
Max. Switching Speed	R11: 0.3m/s - R13: 0.3m/s - R31/R32: 1m/s - R41/R51: 1.5m/s
Max. Switching Frequency	3,600 operations/hour
Case Material	Thermoplastic
Operating Temperature	-25° to +70°C [-13° to +158°F]
Enclosure Protection	IP65
Mechanical Life Expectancy	1 million operations
Vibration	According to EN 60068-2-6
Conductor Size	0.75 to 2.5 mm ²
Recommended Head Screws Torque	0.5 Nm recommended / 0.8 Nm maximum
Recommended Lid Screws Torque	0.5 Nm recommended / 0.8 Nm maximum
Recommended Mounting Bolt Torque	1 Nm
Recommended Mounting Screws	M4
Agency Approvals	CE - cULus - IMQ - CCC - EAC

Safety Products



Warning: Safety products sold by AutomationDirect are Safety components only. The purchaser/installer is solely responsible for the application of these components and ensuring all necessary steps have been taken to assure each application and use meets all performance and applicable safety requirements and/or local, national and/or international safety codes as required by the application. AutomationDirect cannot certify that our products, used solely or in conjunction with other AutomationDirect or other vendors' products, will assure safety for any application. Any person using or applying any products sold by AutomationDirect is responsible for learning the safety requirements for their individual application and applying them, and therefore assumes all risks, and accepts full and complete responsibility, for the selection and suitability of the product for their respective application.

AutomationDirect does not provide design or consulting services, and cannot advise whether any specific application or use of our products would ensure compliance with the safety requirements for any application.