

# C-more CM5 Series Overview

## C-more CM5 Series Touch Panels

- Compatible with EA9 project versions 6.73 or newer
- Analog touch screen
- 16.7-million colors LCD for enhanced graphics
- Screen resolutions up to 1920 X 1080 pixel
- FTP client/server
- E-mail client
- Webserver (Secure HTTPs)
- MQTT client
- User configurable LED on the front of the panel
- Project simulation
- Up to (2) Ethernet ports
- Up to 3 serial ports, RS-232C, RS422/485
- Up to (4) USB-A ports for logging, backups, and HID devices
- Programming via USB or Ethernet
- Thousands of built-in symbols and Windows fonts
- Network time server/client
- JPEG and JPG graphic object support
- Ethernet Remote Access
- Customizable label on the front of the panel
- 2-year warranty from date of purchase



Part Number	Price	Description	Drawing Link
<a href="#"><u>CM5-T4W</u></a>	\$340.00	<b>C-more</b> CM5 series touch screen HMI, 4.3in color TFT LCD, analog resistive, widescreen, 480 x 272 pixel, WQVGA, LED backlight, (1) Ethernet, (2) serial and (2) USB ports and (1) memory card slot.	<a href="#"><u>PDF</u></a>
<a href="#"><u>CM5-T7W</u></a>	\$479.00	<b>C-more</b> CM5 series touch screen HMI, 7in color TFT LCD, analog resistive, widescreen, 800 x 480 pixel, WVGA, LED backlight, (1) Ethernet, (2) serial and (2) USB ports and (1) memory card slot.	<a href="#"><u>PDF</u></a>
<a href="#"><u>CM5-T10W</u></a>	\$769.00	<b>C-more</b> CM5 series touch screen HMI, 10.1in color TFT LCD, analog resistive, widescreen, 1024 x 600 pixel, WSVGA, LED backlight, (2) Ethernet, (3) serial and (4) USB ports and (1) memory card slot.	<a href="#"><u>PDF</u></a>
<a href="#"><u>CM5-T12W</u></a>	\$1,029.00	<b>C-more</b> CM5 series touch screen HMI, 12.1in color TFT LCD, analog resistive, widescreen, 1280 x 800 pixel, WXGA, LED backlight, (2) Ethernet, (3) serial and (4) USB ports and (1) memory card slot.	<a href="#"><u>PDF</u></a>
<a href="#"><u>CM5-T15W</u></a>	\$1,609.00	<b>C-more</b> CM5 series touch screen HMI, 15.6in color TFT LCD, analog resistive, widescreen, 1366 x 768 pixel, HD, LED backlight, (2) Ethernet, (3) serial and (4) USB ports and (1) memory card slot.	<a href="#"><u>PDF</u></a>
<a href="#"><u>CM5-T22W</u></a>	\$1,999.00	<b>C-more</b> CM5 series touch screen HMI, 21.5in color TFT LCD, analog resistive, widescreen, 1920 x 1080 pixel, FHD, LED backlight, (2) Ethernet, (3) serial and (4) USB ports and (1) memory card slot.	<a href="#"><u>PDF</u></a>
<a href="#"><u>CM5-RHMI</u></a>	\$599.00	<b>C-more</b> CM5 series headless HMI, (2) serial, (2) Ethernet and (5) USB ports, (1) HDMI audio/video out and (1) memory card slot.	<a href="#"><u>PDF</u></a>

# C-more 4" TFT Color Touch Panel

## CM5-T4W

**C-more** CM5 series touch screen HMI, 4.3-inch color TFT LCD, 16.7M colors, 480 x 272 pixel WQVGA screen resolution, 800 MHz CPU, 12-24 VDC powered, NEMA 4/4X, IP65 (when mounted correctly; for indoor use only). Includes (1) Ethernet, (2) serial and (2) USB ports and (1) memory card slot. Compatible with [CM5-PGMSW](#) programming software v8.0 or later.

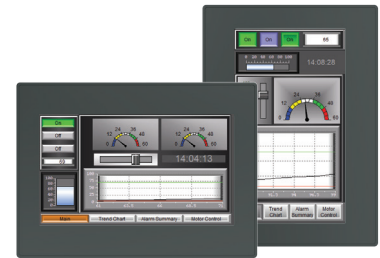

**\$340.00**

## Features

- 4.3" diagonal color TFT (thin film transistor) LCD display with 16.7M colors
- 480 x 272 pixel resolution
- 310 nits display brightness
- 50,000 hour average backlight half-life
- Analog resistive (1024 X 1024) touch screen allowing unlimited touch areas
- (1) USB port B (program/download)
- (1) USB port A (USB device options)
- Ethernet 10/100 Base-T port (program/download & PLC communication)
- Ethernet Remote Access
- Serial PLC interface (RS-232C/422/485)
- Horizontal or portrait mounting
- One built-in SD memory card slot
- 12-24 VDC powered
- 45MB project memory
- Data logging
- 0 to 50°C [32 to 122°F] operating temperature range
- NEMA 4/4X, IP65 compliant when mounted correctly, indoor use only
- Slim design saves enclosure space
- Works with Remote HMI Mobile App



Function	Available
Ethernet	1 Port
USB	2 Ports
SD Card	1 Slot
Audio Out	USB*
RJ12 (RS-232C)	Yes
DB15 (RS-232C, RS-422, RS-485)	Yes
RS-485 3-wire	USB**
*with USB to Audio Adapter	
** with ADC part number - USB-485M	

## Communication Ports

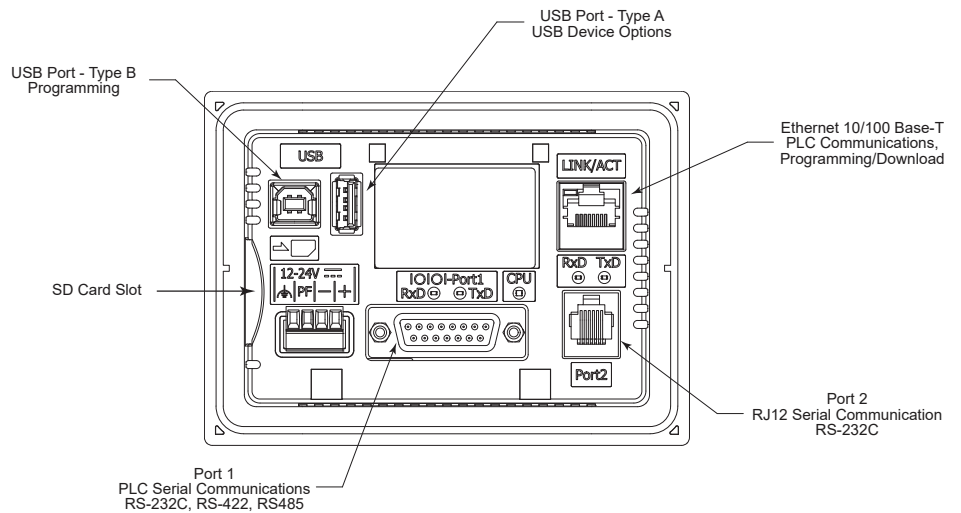

## Cutout Dimensions

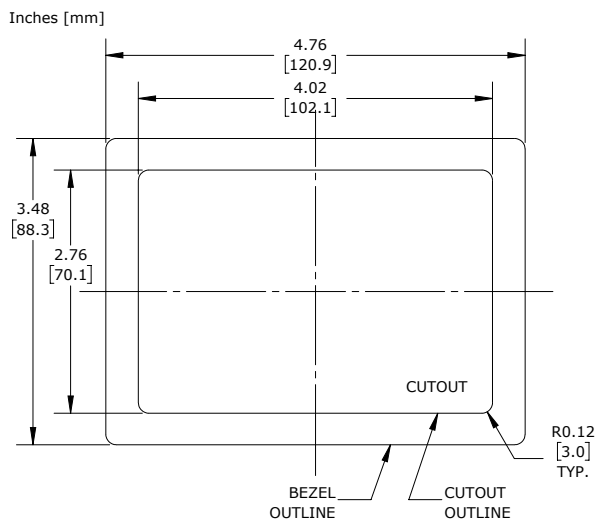

# C-more Selection Guide & Specifications

Specifications		
Model	4" TFT color	7" TFT color
Part Number	CM5-T4W	CM5-T7W
Price	\$340.00	\$479.00
Display Actual Size and Type	4.3" color TFT LCD	7.0" color TFT LCD
Display Viewing Area	95.04 mm x 53.856 mm [3.74" x 2.12"]	154.08 mm x 85.92 mm [6.07" x 3.38"]
Weight	0.46lbs	1.36lbs
Screen Pixel	480 x 272 (WQVGA)	800 x 480 (WVGA)
Display Brightness	310 nits (typ)	
LCD Panel Dot Pitch	0.198 mm x 0.198 mm	0.1926 mm x 0.179 mm
Color Scale	16.7 M colors	
Backlight Average Lifetime*	50,000 hours @ 25°C	
Touch Panel Type**	Four-wire analog resistive, single touch	
Project Memory	45MB	
Number of Screens	Up to 999 screens – limited by project memory	
Realtime Clock	Realtime clock built into panel, backed up for 30 days at 25°C	
Calendar – Month / Day / Year	Yes - monthly deviation 60sec (Reference)	
Serial Port 1	15-pin D-sub female – RS232C, RS-422/485	
Serial Port 2	RJ-12 modular jack – RS-232C	
Serial Port 3	N/A	
USB Port – Type B	USB 2.0 High speed (480 Mbps) Type B – Download/Program – Max. cable length 15-feet	
USB Port – Type A	USB 2.0 High speed (480 Mbps) Type A – for USB device options – Max. cable length 15-feet – Bus Power – Less than 500mA at 5VDC	
Ethernet Port	10/100 Base-T	
Ethernet Port – Expansion Module	N/A	
Audio Line Out	Only with USB to Audio adapter (Not included)	
Mic In (Future)	No	
SD Card Slot	1 slot supports max 2GB (SD), max 32GB (SDHC)	
HDMI Video Out	N/A	
HDMI Supported Resolution	N/A	
Supply Power	10.2-26.4 VDC Class 2 or SELV (Safety Extra-Low Voltage) Circuit / Limited Energy Circuit (LEC). Reverse Polarity Protected	
Power Consumption	8.0 W 0.67 A @ 12VDC 0.33 A @ 24VDC	10.0 W 0.83 A @ 12VDC 0.42 A @ 24VDC
Internal Fuse (non-replaceable)	4.0A	
Altitude	Up to 2000m (6562ft)	
Operating Temperature	0 to 50°C (32 to 122°F) Maximum surrounding air temperature rating: 50°C (122°F) IEC 60068-2-14 (Test Nb, Thermal Shock)	
Storage Temperature	-20 to +60°C (-4 to +140°F) IEC 60068-2-1 (Test Ab, Cold); IEC 60068-2-2 (Test Bb, Dry Heat) IEC 60068-2-14 (Test Na, Thermal Shock)	
Humidity	5-95% RH (non-condensing)	
Environment	For use in Pollution Degree 2 environment, no corrosive gases permitted	
Noise Immunity	(EN61131-2), EN61000-4-2 (ESD), EN61000-4-3 (RFI), EN61000-4-4 (FTB), EN61000-4-5 (Surge), EN61000-4-6 (Conducted); EN61000-4-8 (Power frequency magnetic field immunity); (Local Test) RFI, (145MHz, 440Mhz 10W @ 10cm), Impulse 1000V @ 1µs pulse	
Withstand Voltage	1000VAC, 1min. (FG to Power supply)	
Insulation Resistance	> 10M ohm @ 500VDC (FG to Power supply)	
Vibration	IEC60068-2-6 (Test Fc)	
Shock	IEC60068-2-27 (Test Ea)	
Emission	EN55011 Class A (Radiated RF emission)	
Enclosure	NEMA 250 type 4/4X indoor use only UL50 type 4X indoor use only IP-65 indoor use only (When mounted correctly)	
Agency Approvals	UL61010, CE (EN61131-2), RoHS (2011/65/EU), CUL Canadian C22.2	

NOTES: \*The backlight average lifetime is defined as the average usage time it takes before the brightness becomes 50% of the initial brightness. The lifetime of the backlight depends on the ambient temperature. The lifetime will decrease under low or high temperature usage.

\*\*The touchscreen is designed to respond to a single touch. If it is touched at multiple points at the same time, an unexpected object may be activated.

# C-more Selection Guide & Specifications

Specifications				
Model	10" TFT color	12" TFT color	15" TFT color	22" TFT color
Part Number	CM5-T10W	CM5-T12W	CM5-T15W	CM5-T22W
Price	\$769.00	\$1,029.00	\$1,609.00	\$1,999.00
Display Actual Size and Type	10.1" color TFT LCD	12.1" color TFT LCD	15.6" color TFT LCD	21.5" color TFT LCD
Display Viewing Area	222.72mm x 125.28mm [8.77" x 4.93"]	261.12mm x 163.2mm [10.28" x 6.43"]	344.232mm x 193.536mm [13.55" x 7.62"]	476.064mm x 267.786mm [18.74" x 10.54"]
Weight	2.29lbs	3.44lbs	5.51lbs	12.88lbs
Screen Pixel	1024 x 600 (WSVGA)	1280 x 800 (WXGA)	1366 x 768 (HD)	1920 x 1080 (FHD)
Display Brightness	315 nits (typ)	280 nits (typ)		
LCD Panel Dot Pitch	0.2175 x 0.2088 mm	0.2040mm x 0.2040 mm	0.252mm x 0.252 mm	0.24795mm x 0.24795 mm
Color Scale	16.7 M colors			
Backlight Average Lifetime*	50,000 hours @ 25°C			
Touch Panel Type**	Four-wire analog resistive, single touch			
Project Memory	90MB			
Number of Screens	Up to 999 screens – limited by project memory			
Realtime Clock	Realtime clock built into panel, backed up for 30 days at 25°C			
Calendar – Month / Day / Year	Yes - monthly deviation 60sec (Reference)			
Serial Port 1	15-pin D-sub female – RS232C, RS-422/485			
Serial Port 2	RJ-12 modular jack – RS-232C			
Serial Port 3	3-wire terminal block – RS-485			
USB Port – Type B	USB 2.0 High speed (480 Mbps) Type B – Download/Program – Max. cable length 15-feet			
USB Port – Type A	(3) USB 2.0 High speed (480 Mbps) Type A – for USB device options – Max. cable length 15-feet – Bus Power – Less than 500mA each (less than 1500mA total) at 5VDC			
Ethernet Port	(2) 10/100 Base-T			
Ethernet Port – Expansion Module	N/A			
Audio Line Out	Only with USB to Audio adapter (Not included)			
Mic In (Future)	No			
SD Card Slot	1 slot supports max 2GB (SD), max 32GB (SDHC) max 2TB (SDXC)			
HDMI Video Out	N/A			
HDMI Supported Resolution	N/A			
Supply Power	10.2-26.4 VDC Class 2 or SELV (Safety Extra-Low Voltage) Circuit / Limited Energy Circuit (LIM), Reverse Polarity Protected			
Power Consumption	21.0 W 1.75 A @ 12VDC 0.88 A @ 24VDC	35.0 W 2.92 A @ 12VDC 1.46 A @ 24VDC		40.0 W 3.33 A @ 12VDC 1.67 A @ 24VDC
Internal Fuse (non-replaceable)	12A			
Altitude	Up to 2000m (6562ft)			
Operating Temperature	0 to 50°C (32 to 122°F) Maximum surrounding air temperature rating: 50°C (122°F) IEC 60068-2-14 (Test Nb, Thermal Shock)			
Storage Temperature	-20 to +60°C (-4 to +140°F) IEC 60068-2-1 (Test Ab, Cold) IEC 60068-2-2 (Test Bb, Dry Heat) IEC 60068-2-14 (Test Na, Thermal Shock)			
Humidity	5-95% RH (non-condensing)			
Environment	For use in Pollution Degree 2 environment, no corrosive gases permitted			
Noise Immunity	(EN61131-2), EN61000-4-2 (ESD), EN61000-4-3 (RFI), EN61000-4-4 (FTB), EN61000-4-5 (Surge), EN61000-4-6 (Conducted) EN61000-4-8 (Power frequency magnetic field immunity) (Local Test) RFI, (145MHz, 440Mhz 10W @ 10cm), Impulse 1000V @ 1µs pulse			
Withstand Voltage	1000VAC, 1min. (FG to Power supply)			
Insulation Resistance	> 10M ohm @ 500VDC (FG to Power supply)			
Vibration	IEC60068-2-6 (Test Fc)			
Shock	IEC60068-2-27 (Test Ea)			
Emission	EN55011 Class A (Radiated RF emission)			
Enclosure	NEMA 250 type 4/4X indoor use only UL50 type 4X indoor use only; IP-65 indoor use only (When mounted correctly)			
Agency Approvals	UL61010, CE (EN61131-2), RoHS (2011/65/EU), CUL Canadian C22.2			

NOTES: \*The backlight average lifetime is defined as the average usage time it takes before the brightness becomes 50% of the initial brightness. The lifetime of the backlight depends on the ambient temperature. The lifetime will decrease under low or high temperature usage.

\*\*The touchscreen is designed to respond to a single touch. If it is touched at multiple points at the same time, an unexpected object may be activated.

# C-more Selection Guide & Specifications













Specifications	
<b>Model</b>	<b>Headless</b>
<b>Part Number</b>	CM5-RHMI
<b>Price</b>	\$599.00
<b>Display</b>	None
<b>Weight</b>	480g(1.06lb)
<b>Project Memory</b>	90MB
<b>Number of Screens</b>	Up to 999 screens – limited by project memory
<b>Realtime Clock</b>	Realtime clock built into panel, backed up for 30 days at 25°C
<b>Calendar – Month / Day / Year</b>	Yes - monthly deviation 60sec (Reference)
<b>Serial Port 1</b>	15-pin D-sub female – RS232C, RS-422/485
<b>Serial Port 2</b>	3-wire terminal block – RS-485
<b>USB Port – Type B</b>	USB 2.0 High speed (480 Mbps) Type B – Download/Program – Max. cable length 15-feet
<b>USB Port – Type A</b>	(4) USB 2.0 High speed (480 Mbps) Type A – for USB device options – Max. cable length 15-feet – Bus Power – Less than 500mA each (less than 2000mA total) at 5VDC
<b>Ethernet Port</b>	(2) 10/100 Base-T
<b>Audio Line Out</b>	Only with USB to Audio adapter (Not included)
<b>Mic In (Future)</b>	No
<b>SD Card Slot</b>	1 slot supports max 2GB (SD), max 32GB (SDHC) max 2TB (SDXC)
<b>HDMI Video Out</b>	HDMI Type A Port
<b>HDMI Supported Resolution</b>	640 x 480 (VGA) 60Hz 720 x 480 (SD) 60Hz 1024 x 768 (XGA) 60Hz 1280 x 720 (HD) 60Hz 1920 x 1080 (FHD) 60Hz With automatic negotiation function for HDMI displays
<b>Supply Power</b>	10.2-26.4 VDC Class 2 or SELV (Safety Extra-Low Voltage) Circuit / Limited Energy Circuit (LIM), Reverse Polarity Protected
<b>Power Consumption</b>	18.0 W 1.50 A @ 12VDC 0.875 A @ 24VDC
<b>Internal Fuse (non-replaceable)</b>	12A
<b>Altitude</b>	Up to 2000m (6562ft)
<b>Operating Temperature</b>	0 to 50°C (32 to 122°F) Maximum surrounding air temperature rating: 50°C (122°F) IEC 60068-2-14 (Test Nb, Thermal Shock)
<b>Storage Temperature</b>	-20 to +60°C (-4 to +140°F) IEC 60068-2-1 (Test Ab, Cold) IEC 60068-2-2 (Test Bb, Dry Heat) IEC 60068-2-14 (Test Na, Thermal Shock)
<b>Humidity</b>	5-95% RH (non-condensing)
<b>Environment</b>	For use in Pollution Degree 2 environment, no corrosive gases permitted
<b>Noise Immunity</b>	(EN61131-2) EN61000-4-2 (ESD) EN61000-4-3 (RFI) EN61000-4-4 (FTB) EN61000-4-5 (Surge) EN61000-4-6 (Conducted) EN61000-4-8 (Power frequency magnetic field immunity) (Local Test) RFI, (145MHz, 440Mhz 10W @ 10cm) Impulse 1000V @ 1µs pulse
<b>Withstand Voltage</b>	1000VAC, 1min. (FG to Power supply)
<b>Insulation Resistance</b>	> 10M ohm @ 500VDC (FG to Power supply)
<b>Vibration</b>	IEC60068-2-6 (Test Fc)
<b>Shock</b>	IEC60068-2-27 (Test Ea)
<b>Emission</b>	EN55011 Class A (Radiated RF emission)
<b>Agency Approvals</b>	UL61010, CE (EN61131-2), RoHS (2011/65/EU) and amendment(EU)2015/863, CUL Canadian C22.2

# C-more Communication Protocols

Compatibility Table			
PLC Family	Model		Protocols
<b>Allen-Bradley</b>	MicroLogix 1000, 1100, 1200, 1400 and 1500		DF1 Half Duplex; DF1 Full Duplex
	SLC 5-03/04/05		
	ControlLogix™, CompactLogix™, FlexLogix™		DF1 Full Duplex
	PLC-5		
	ControlLogix, CompactLogix, FlexLogix - Tag Based		DF1 Half Duplex; DF1 Full Duplex
	ControlLogix, CompactLogix, FlexLogix - Generic I/O Messaging		
	ControlLogix, CompactLogix, FlexLogix - Tag Based		EtherNet/IP Server
	Micrologix 1100, 1400 & SLC5/05, all via native Ethernet port		
	MicroLogix 1000, 1100, 1200, 1400, 1500 & SLC 5-03/04/05, all via ENI Adapter		EtherNet/IP Client
	Micro 800 series		
<b>Modbus RTU</b>	Modbus RTU devices		Modbus RTU
	Modbus TCP/IP devices		Modbus TCP/IP
<b>Modbus TCP/IP</b>	Modbus RTU devices		Modbus RTU
	Modbus TCP/IP devices		Modbus TCP/IP
<b>GE</b>	90/30, 90/70, Micro 90, VersaMax Micro		SNPX
	90/30, Rx3i		S RTP Ethernet
<b>Mitsubishi</b>	FX Series		FX Direct
	Q02, Q02H, Q06H, Q12H, Q25H		Q CPU
	Q, QnA Serial		QnA Serial
	Q, QnA Ethernet		QnA Ethernet
<b>Omron</b>	C200 Adapter, C500		Host Link
	CJ1/CS1 Serial, CJ1/CS1 Ethernet		FINS
<b>Modicon</b>	984 CPU, Quantum 113 CPU, AEG Modicon Micro Series 110 CPU: 311-xx, 411-xx, 512-xx, 612-xx		Modbus RTU
<b>Siemens</b>	S7-200 CPU, RS-485 Serial		PPI
	S7-200 CPU, S7-300 CPU, S7-400, S7-1200 CPU, S7-1500; Ethernet		Ethernet ISO over TCP
<b>Productivity Series</b>	all		Productivity Serial
<b>Do-more</b>	all		Productivity Ethernet
<b>CLICK</b>	all		Do-more Serial
	all		Do-more Ethernet
<b>Direct LOGIC</b>	DL05/DL06	all	Modbus (CLICK addressing)
		H0-ECOM/H0-ECOM100	Modbus TCP (CLICK addressing)
	DL105	all	K-Sequence
		H0-ECOM/H0-ECOM100	DirectNET
	DL205	D2-230	Modbus (Koyo addressing)
		D2-240	Direct LOGIC Ethernet
		D2-250/D2-250-1/D2-260/D2-262	K-Sequence
		D2-240/D2-250-1/D2-260 using D2-DCM	K-Sequence
		H2-ECOM/H2-ECOM100	DirectNET
			Modbus (Koyo addressing)
			DirectNET
	DL305	D3-330/330P (Requires the use of a Data Communications Unit)	Modbus (Koyo addressing)
		D3-340	Direct LOGIC Ethernet
		D3-350	DirectNET
		D3-350 using D3-DCM	K-Sequence
			DirectNET
	DL405	D4-430	Modbus (Koyo addressing)
		D4-440	DirectNET
		D4-450/D4-454	K-Sequence
		All with D4-DCM	DirectNET
		H4-ECOM/H4-ECOM100	Modbus (Koyo addressing)
			DirectNET
			Modbus (Koyo addressing)
	H2-WinPLC (Think & Do) Live V5.2 or later and Studio any version		Direct LOGIC Ethernet
	H2-WinPLC (Think & Do) Live V5.5.1 or later and Studio V7.2.1 or later		Think & Do Modbus RTU (serial port)
			Think & Do Modbus TCP/IP (Ethernet port)



# C-more Communication Cables

Cable Part Number	Product Photo	Cable Description	Price
<a href="#"><u>EA-2CBL</u></a>		AutomationDirect communication cable, 15-pin male D-sub to 6-pin RJ12, shielded, 9.8ft/3m cable length. For use with <b>C-more</b> or <b>C-more</b> Micro panel and AutomationDirect PLCs with RJ12 ports.	\$31.00
<a href="#"><u>EA-2CBL-1</u></a>		AutomationDirect communication cable, 15-pin male D-sub to 15-pin D-sub HD15 male, shielded, 3m/9.8ft cable length. For use with <b>C-more</b> or <b>C-more</b> Micro panel and a DL06, D2-250(-1), D2-260 or D2-262 (bottom port) CPU.	\$31.50
<a href="#"><u>EA-3CBL</u></a>		AutomationDirect communication cable, 15-pin male D-sub to 4-pin RJ11, shielded, 3m/9.8ft cable length. For use with <b>C-more</b> or <b>C-more</b> Micro panel and a D3-340 CPU top or bottom port.	\$31.00
<a href="#"><u>EA-4CBL-1</u></a>		AutomationDirect communication cable, 15-pin male D-sub to 15-pin male D-sub, shielded, 3m/9.8ft cable length. For use with <b>C-more</b> or <b>C-more</b> Micro panel and a DL405 (top port) CPU.	\$31.00
<a href="#"><u>EA-4CBL-2</u></a>		AutomationDirect communication cable, 15-pin male D-sub to 25-pin male D-sub, shielded, 3m/9.8ft cable length. For use with <b>C-more</b> or <b>C-more</b> Micro panel and a D2-DCM, D3-232-DCU, D3-350 (bottom port) or DL405 (bottom port) CPU.	\$32.00
<a href="#"><u>EA-MLOGIX-CBL</u></a>		AutomationDirect communication cable, 15-pin male D-sub to 8-pin male mini DIN, shielded, 3m/9.8ft cable length. For use with <b>C-more</b> or <b>C-more</b> Micro panel and an Allen-Bradley Micrologix CPU.	\$47.50
<a href="#"><u>EA-SLC-232-CBL</u></a>		AutomationDirect communication cable, 15-pin male D-sub to 9-pin female D-sub, shielded, 3m/9.8ft cable length. For use with <b>C-more</b> or <b>C-more</b> Micro panel and an Allen-Bradley SLC 5/03, 5/04 or 5/05 CPU with DF-1 port.	\$31.00
<a href="#"><u>EA-PLC5-232-CBL</u></a>		AutomationDirect communication cable, 15-pin male D-sub to 25-pin male D-sub, 3m/9.8ft cable length. For use with <b>C-more</b> or <b>C-more</b> Micro panel and an Allen-Bradley PLC-5 CPU with a DF1 port.	\$31.00
<a href="#"><u>EA-90-30-CBL</u></a>		AutomationDirect communication cable, 15-pin male D-sub to 15-pin male D-sub, shielded, 3m/9.8ft cable length. For use with <b>C-more</b> or <b>C-more</b> Micro and GE Fanuc Series 90/30 or 90/70 serial port.	\$31.00
<a href="#"><u>EA-MITSU-CBL</u></a>		AutomationDirect communication cable, 15-pin male D-sub to 25-pin male D-sub, 3m/9.8ft cable length. For use with <b>C-more</b> or <b>C-more</b> Micro panel and a Mitsubishi FX Series CPU.	\$31.00
<a href="#"><u>EA-MITSU-CBL-1</u></a>		AutomationDirect communication cable, 15-pin male D-sub to 8-pin male mini DIN, shielded, 3m/9.8ft cable length. For use with <b>C-more</b> or <b>C-more</b> Micro panel and a Mitsubishi FX Series CPU.	\$31.00
<a href="#"><u>EA-OMRON-CBL</u></a>		AutomationDirect communication cable, 15-pin male D-sub to 25-pin male D-sub, shielded, 3m/9.8ft cable length. For use with <b>C-more</b> or <b>C-more</b> Micro panel and an Omron C200 or C500 CPU.	\$31.00

Note - Refer to the appropriate User Manual for specific cable pinouts, communication protocols and connection instructions.

# C-more Accessories

## Accessories

C-more touch panels can be enhanced with the accessories below:

Part Number	Price	Description
<a href="#"><u>HMI-4W-COV</u></a>	\$44.50	C-more screen protector, non-glare, 4.3in. Package of 3. For use with C-more 4in widescreen HMIs.
<a href="#"><u>HMI-7W-COV</u></a>	\$51.00	C-more screen protector, non-glare, 7in. Package of 3. For use with C-more 7in widescreen HMIs.
<a href="#"><u>HMI-10W-COV</u></a>	\$59.00	C-more screen protector, non-glare, 10.1in. Package of 3. For use with C-more 10in widescreen HMIs.
<a href="#"><u>HMI-12W-COV</u></a>	\$43.00	C-more screen protector, non-glare, 12.1in. Package of 3. For use with C-more CM5-T12W widescreen HMIs.
<a href="#"><u>HMI-15W-COV</u></a>	\$49.00	C-more screen protector, non-glare, 15.6in. Package of 3. For use with C-more CM5-T15W widescreen HMIs.
<a href="#"><u>HMI-22W-COV</u></a>	\$73.00	C-more screen protector, non-glare, 21.5in. Package of 3. For use with C-more CM5-T22W widescreen HMIs.
<a href="#"><u>EA-SD-CARD</u></a>	\$130.00	C-more industrial memory card, 2GB SD. For use with all products with SD memory card slot.
<a href="#"><u>MSD-SLC16G</u></a>	\$100.00	CLICK industrial memory card, 16GB microSD. For use with all products with microSD memory card slot.
<a href="#"><u>USB-FLASH</u></a>	\$25.50	SanDisk USB Flash drive, 32GB.
<a href="#"><u>EA-COMCON-3</u></a>	\$55.00	C-more DSUB port adapter, 15-pin male to 6-pole RS-422/485 terminal block, right angle cable entry. For use with C-more Micro EA1 series 4in and 6in HMIs, C-more Micro EA3 series 3in, 4in, and 6in HMIs, C-more EA9 6in and 7in HMIs and C-more CM5 series 4in HMI.
<a href="#"><u>EA-COMCON-3A</u></a>	\$30.50	C-more Micro DSUB port adapter, 15-pin male to 6-pole RS-422/485 terminal block, straight cable entry. For use with C-more Micro EA1 3in with EA1-MG-SP1, EA3 8in and 10in HMIs, C-more EA9 8in, 10in, 12in and 15in and CM5 7in, 10in, 12in, 15in and 22in HMIs.

## Accessory Locations

### CM5-T4W

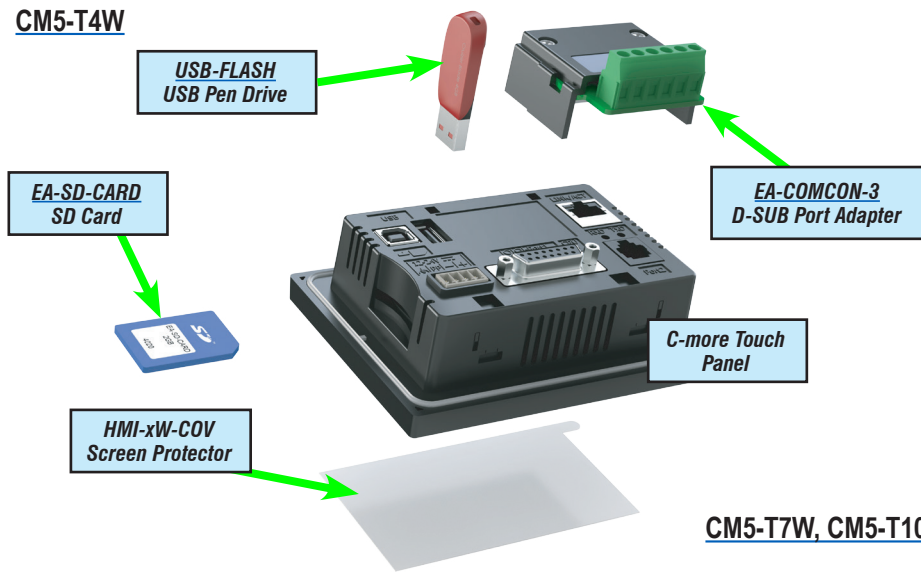

### CM5-T7W, CM5-T10W, CM5-T12W, CM5-T15W, CM5-T22W

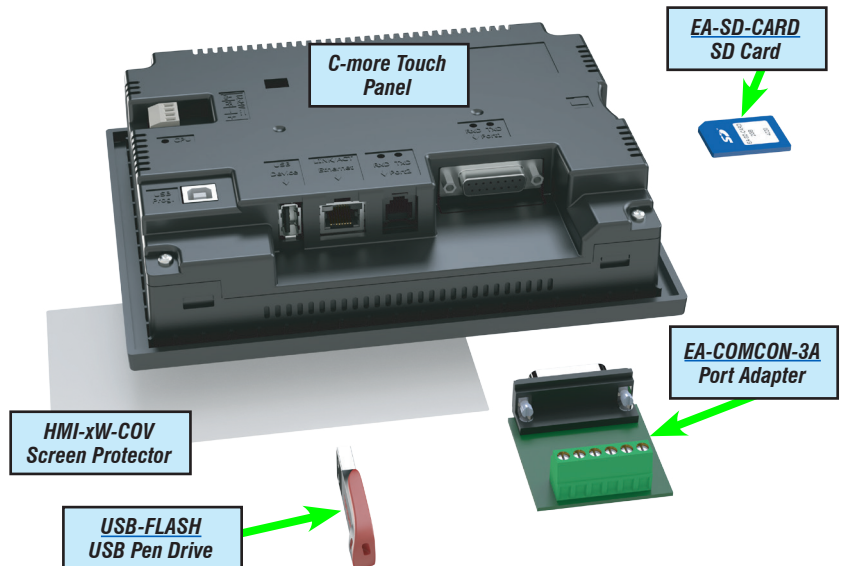



# C-more Accessories

## SD Cards

### EA-SD-CARD



**\$130.00**

### MSD-SLC16G

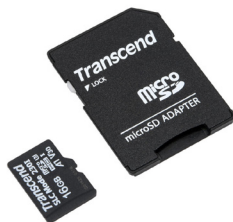

**\$100.00**

SD memory cards for non-volatile storage, 2GB or 16GB industrial grade. High operating temperature make [EA-SD-CARD](#) and [MSD-SLC16G](#) suitable for data logging in industrial applications. These cards are recommended for **C-more** CM5 series.

[EA-SD-CARD](#) and [MSD-SLC16G](#) utilize SLC technology so they are the fastest and most reliable option for writing and storing data. If logged data is saved to external memory, AutomationDirect recommends using [EA-SD-CARD](#) and [MSD-SLC16G](#). SLC Flash has the longest lifespan of flash types and can operate in a broader temperature range than other types.

[EA-SD-CARD](#) and [MSD-SLC16G](#) with SLC Flash memory is recommended for industrial workloads that require heavy read / write cycles.

SD Card Specifications		
Part Number	<a href="#">EA-SD-CARD</a>	<a href="#">MSD-SLC16G</a>
Operating Temperature	0 to 70°C (32 to 158°F)	-40 to 85°C (-40 to 185°F)
Humidity	20 to 85% (non-condensing)	0 to 95% (non-condensing)
Capacity	2GB	16GB
Flash Type	SLC	3D NAND Flash (SLC Mode)
Speed Modes	High-Speed Normal-Speed	UHS-I
Interface	SD Memory Card Specification Ver. 3.0	SD Memory Card Specification Ver. 5.1
Speed Class	Class 6	Class 10

## USB Flash Drive

### USB-FLASH



**\$25.50**

[USB-FLASH](#) sold by AutomationDirect has been tested with **C-more** HMIs and is Hi-Speed USB 2.0 certified. The [MSD-SLC16G](#) is the best option for logging data, but the [USB-FLASH](#) is a high-quality flash drive perfect for transferring log files, capturing screens, backing up and restoring projects and storing images for the Image Viewer object.

# C-more Accessories

## D-SUB 15-pin to Terminal Block Adapter - Right Angle

The EA-COMCON-3 adapter plugs into the 15-pin serial port on the rear of a panel to allow wire terminal connections for an RS-422/RS-485 communication cable. For use with **C-more** Micro EA1 series 4in and 6in HMIs, **C-more** Micro EA3 series 3in, 4in, and 6in HMIs, **C-more** EA9 series 6in and 7in HMIs, **C-more** CM5 series 4in HMI.

**Part No.**  
**EA-COMCON-3**



**\$55.00**

### Dimensions

Units: inches [mm]

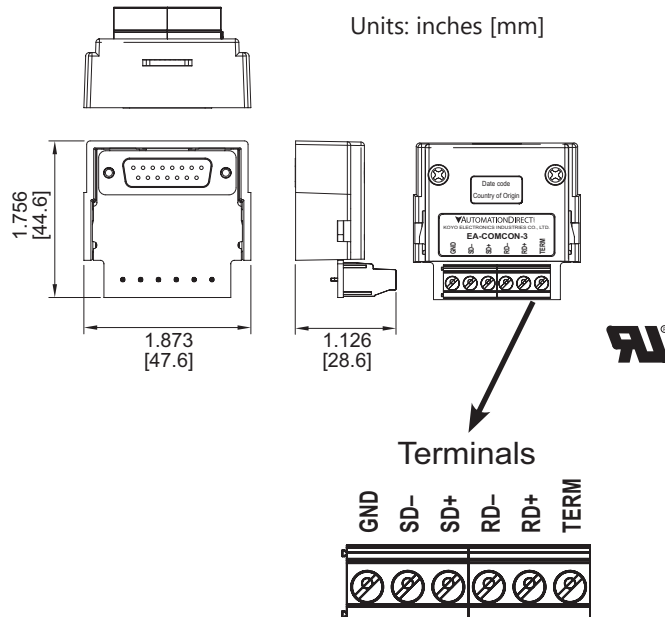

## D-SUB 15-pin to Terminal Block Adapter - Straight Through

The EA-COMCON-3A adapter plugs into the 15-pin serial port on the rear of a panel to allow wire terminal connections for an RS-422/RS-485 communication cable. For use with **C-more** Micro EA1 series 3in with EA1-MG-SP1, **C-more** Micro EA3 series 8in and 10in HMIs, **C-more** EA9 series 8in, 10in, 12in and 15in HMIs, **C-more** CM5 series Headless, 7in, 10in, 12in, 15in, and 22in HMIs. The EA-COMCON-3A is not UL recognized or listed.

**Part No.**  
**EA-COMCON-3A**



**\$30.50**

### Dimensions

Units: inches [mm]

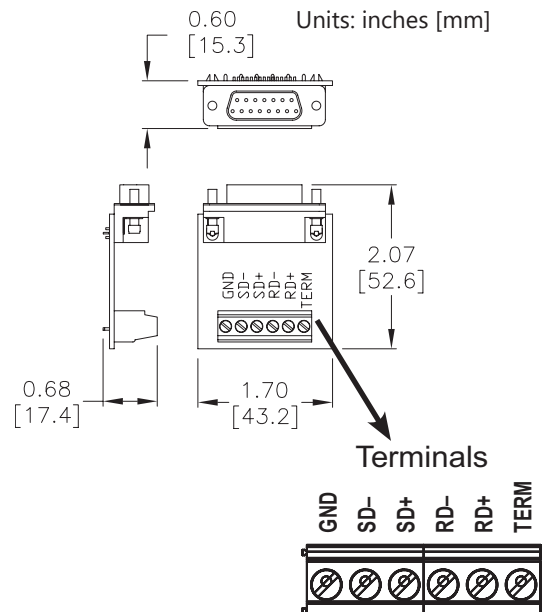

EA-COMCON-3(A) Wiring Specs	
Wire Size	Screw Torque
14-24 AWG	4.4 lb-in [0.5 Nm]

# C-more Accessories

## Non-glare Screen Covers (in packages of 3)

The non-glare screen covers are protective overlays used to protect the touch screen while helping to reduce the glare from external light sources.

**Part Numbers:** HMI-4W-COV, HMI-7W-COV, HMI-10W-COV, HMI-12W-COV, HMI-15W-COV, HMI-22W-COV

### Dimensions

Units: inches [mm]

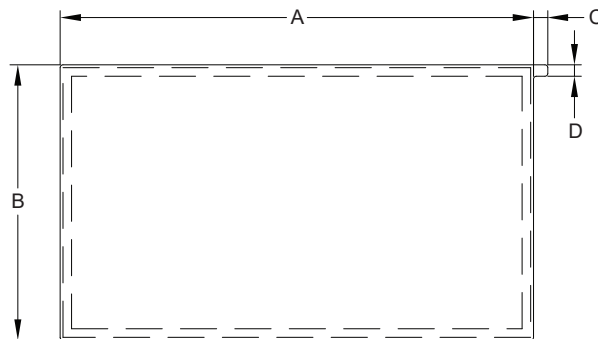
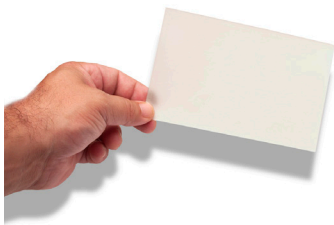

<u>HMI-4W-COV</u>	\$44.50
<u>HMI-7W-COV</u>	\$51.00
<u>HMI-10W-COV</u>	\$59.00
<u>HMI-12W-COV</u>	\$43.00
<u>HMI-15W-COV</u>	\$49.00
<u>HMI-22W-COV</u>	\$73.00

Non-glare Screen Covers Dimensions (inches [mm])				
Part Number	A	B	C	D
<u>HMI-4W-COV</u>	4.15 [105.5]	2.52 [64.0]	0.20 [5.0]	0.16 [4.0]
<u>HMI-7W-COV</u>	6.40 [162.6]	4.00 [101.5]		
<u>HMI-10W-COV</u>	9.23 [234.5]	5.38 [136.7]		
<u>HMI-12W-COV</u>	10.70 [271.9]	6.85 [173.9]		
<u>HMI-15W-COV</u>	14.13 [358.9]	8.19 [208.2]		
<u>HMI-22W-COV</u>	19.33 [491.0]	11.13 [282.6]		

## Installation

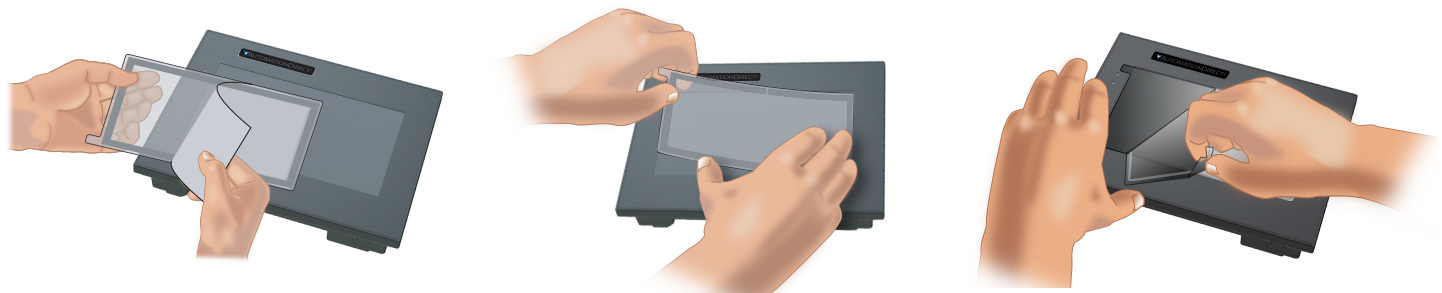





**NOTE:** The Protective Cover ships with a thin protective sheet on the face of the cover that needs to be carefully removed. If your panel is not clear, the protective sheet may not have been removed.

# C-more Replacement Parts

These replacement parts can be used to replace damaged, worn or lost **C-more** components.

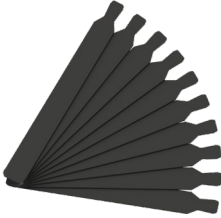
## Replacement parts at a glance:

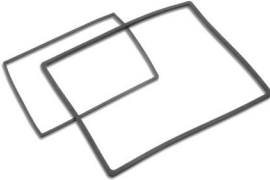
Part Number	Price		Description
<a href="#"><u>HMI-BRK-1</u></a>	\$23.00		<b>C-more</b> panel mounting brackets, replacement. Package of 2. For use with <b>C-more</b> CM5-T4W 4in HMI.
<a href="#"><u>HMI-BRK-2</u></a>	\$35.00		<b>C-more</b> panel mounting brackets, replacement. Package of 8. For use with <b>C-more</b> CM5 series 7in, 10in, 12in, 15in and 22in HMIs.
<a href="#"><u>HMI-LOGO-LBL</u></a>	\$31.00		<b>C-more</b> blank label insert, replacement. Package of 10. For use with <b>C-more</b> CM5 series HMI front bezel.
<a href="#"><u>HMI-3TB</u></a>	\$12.50		<b>C-more</b> pluggable terminal block, replacement, 3-pole. Package of 2. For use with 3-wire RS-485 communications port on <b>C-more</b> CM5 series HMIs.
<a href="#"><u>C0-4TB</u></a>	\$10.00		CLICK terminal blocks, replacement, 4-pole. Package of 2. For use with CLICK PLCs and <b>C-more</b> CM5 series HMIs.
<a href="#"><u>HMI-4W-GSK</u></a>	\$11.50		<b>C-more</b> panel mounting gasket, replacement. For use with <b>C-more</b> CM5-T4W 4in HMI.
<a href="#"><u>HMI-7W-GSK</u></a>	\$27.00		<b>C-more</b> panel mounting gasket, replacement. For use with <b>C-more</b> CM5-T7W 7in HMI.
<a href="#"><u>HMI-10W-GSK</u></a>	\$28.00		<b>C-more</b> panel mounting gasket, replacement. For use with <b>C-more</b> CM5-T10W 10in HMI.
<a href="#"><u>HMI-12W-GSK</u></a>	\$29.00		<b>C-more</b> panel mounting gasket, replacement. For use with <b>C-more</b> CM5-T12W 12in HMI.
<a href="#"><u>HMI-15W-GSK</u></a>	\$30.00		<b>C-more</b> panel mounting gasket, replacement. For use with <b>C-more</b> CM5-T15W 15in HMI.
<a href="#"><u>HMI-22W-GSK</u></a>	\$36.00		<b>C-more</b> panel mounting gasket, replacement. For use with <b>C-more</b> CM5-T22W 22in HMI.

# C-more Programming Software

## CM5-PGMSW - FREE Download!

**C-more** Programming Software can be downloaded at no charge or a USB version may be purchased by ordering CM5-PGMSW. The software requires a USB port or Ethernet connection\* on your PC to connect to the **C-more** panel. Software Help Files are included in the download. This software programs all the **C-more** panels.

## CM5-PGMSW USB Flash Drive



\$12.50

## Software Features

- Over 50 objects including 16 pen trends, switches, PID trend faceplate, PID bar graph
- Event Manager allows for logging and notifications
- Language support for objects in German, French, Italian, Spanish, Chinese and Japanese Characters
- Project simulator
- Bitmap animation
- E-mail messaging
- Built-in FTP server / Webservice (Secure HTTPs)
- Popup windows
- Data logging to USB/SD flash drive
- USB 2.0 Type B port for programming
- Historical alarms with time and date stamp along with alarm frequency reporting
- Supports simultaneous communication to multiple brands of PLC/PACs
- Mouse and keyboard support within the project
- Remote HMI feature with smart phone / tablet / PC
- 2 year warranty

## Computer System Requirements

CM5-PGMSW will run on PCs that meet the following requirements:

- Windows OS: 8: 32 & 64 bit, 8.1: 32 & 64 bit, 10, 11
- 2GB of available memory
- 1GB hard drive space
- Available Ethernet or USB port