

# EATON Starters and Contactors Overview

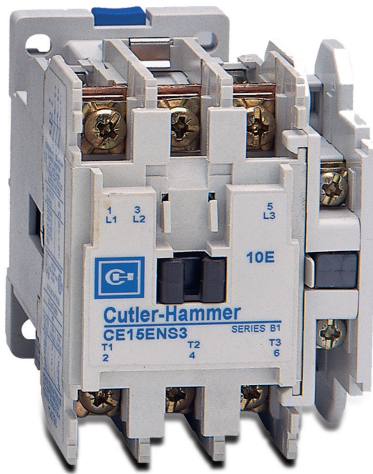

Cutler-Hammer's Freedom series of IEC contactors feature a compact space-saving design.

Components that meet IEC 60947 are more reliable, of higher quality, and are better matched to their intended application.

## Contactors overview

The Cutler-Hammer CE15 Freedom Series IEC contactors offer big contactor ratings in a compact frame. The 45 mm frame contactors can handle up to 20 hp at 460V. They are easily DIN-rail mountable in either the vertical or horizontal upright position. Note: There is not enough space to assemble two contactors into a reversing contactor.

## Starter overview

The Cutler-Hammer AE16 Series IEC starters are full voltage magnetic starters used for starting polyphase induction motors. These starters also provide protection to the motor against running or stalled overcurrents.

The 45 mm frame starters can handle up to 20 hp at 460V. They are easily DIN-rail mountable in either the vertical or horizontal upright position.

Starter are comprised of a contactor, overload relay and heater packs (sold separately). The overload relays have FLA adjustable dials.

## Starter/contactors features and specifications

- EN60947-4-1 IEC 947-4-1 compliance (international standard for low voltage switchgear and control devices)
- UL-listed and CSA-certified
- 45mm frame rated maximum 20 hp at 460V; highest horsepower rating in a compact, space-saving design
- Long-life twin break, silver cadmium oxide contacts for excellent conductivity and superior resistance to welding and arc erosion
- 45mm open contactors, sizes A-F, with DIN-rail or universal base mounting
- DIN rail release mechanism: conveniently located on line side of contactor
- Designed to 2,000,000 electrical and 20,000,000 mechanical operations at maximum hp ratings through 20 hp at 460V. Adequate for most general duty control applications.
- Contactor and terminal markings conform to CENELEC EN50011.
- Holding circuit contact(s) supplied standard
- Lugs supplied standard on sizes A-F
- Tape wound coil
- Straight-through wiring

# Eaton Thermal Overload Relays Overview

Overload relays are provided to protect motors, motor control apparatus and motor-branch circuit conductors against excessive heating due to motor overloads and failure to start.

The C306 overload relay is designed for use with the Cutler-Hammer series non-reversing contactors.

## Time-current characteristics

The time-current characteristics of an overload relay define its operating time at various multiples of its current setting. Underwriters Laboratory (UL) performs tests in accordance with NEMA Standards and the NEC as follows:

- When tested at 100 percent of its current rating, the overload relay shall trip ultimately.
- When tested at 200 percent of its current rating, the overload relay shall trip in not more than eight minutes.
- When tested at 600 percent of its current rating, the overload relay shall trip in not more than 10 or 20 seconds, depending on the class of the relay.

### Definitions

**Current rating:** the minimum current at which the relay will trip. Per NEC, an overload must ultimately trip at 125% of FLA current (heater) setting for a 1.15 service factor motor, and 115% FLA for a 1.0 service factor motor. Current setting: the FLA (Full Load Amperage) of the motor and thus the overload heater pack setting.

**Example:** 600% of current rating is defined as 750% (600 X 1.25) of FLA current (heater) setting for a 1.15 service factor motor. A 10A heater setting must trip in 20 seconds or less at 75A motor current for a Class 20 relay.

## Thermal overload relays feature:

- Selectable manual or automatic reset operations
- Interchangeable Class 20 heater packs  $\pm 24\%$  to match motor FLA and calibrated for 1.0 and 1.15 service factors (ordered separately)
- Integral load lugs which allow field wiring prior to heater pack installation
- Single-phase protection
- Bimetallic, ambient compensated operation
- Trip-free mechanism
- Electrically-isolated N.O. or N.C. contacts
- Overload trip indication
- Fingerproof terminals to reduce possibility of shock
- UL-listed, CSA-certified, NEMA-compliant

## Overload relay setting

### FLA dial adjustment

For motors having a 1.15 service factor, rotate the FLA adjustment dial to correspond to the motor's FLA rating. Estimate the dial position when the motor FLA falls between two letter values, as shown in the example.

For motors having a 1.0 service factor, or to meet IEC 947 requirements, rotate the FLA dial one-half of a position counterclockwise (CCW).

### Manual/automatic reset

The overload relay is factory set at M for manual reset operation. For automatic reset operation, turn the reset adjustment dial to the A position, as shown in the illustration. Automatic reset is not intended for two-wire control devices.

### Test for trip indication

To test overload relay for trip indication when in manual reset, pull out the blue RESET button. An orange flag will appear indicating that the device has tripped. Push RESET button in to reset.

| Thermal Overload Relays |           |              |           |
|-------------------------|-----------|--------------|-----------|
| IEC                     | Max. Amps | No. of Poles | Open Type |
| A-F                     | 32        | 3            | C306DN3B  |

Price: \$262.00

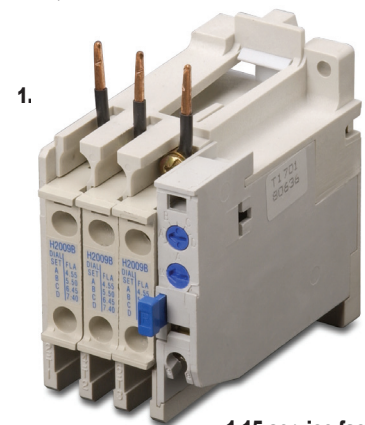

1.

1.15 service factor

Heater packs sold separately

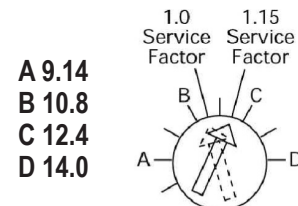

Example of 12.0 FLA setting for heater pack number H2011B showing position for 1.0 or 1.15 service factor motors.

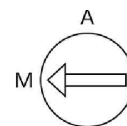

Example of setting of manual reset.

## Class 20 overload relay 25°C open rating

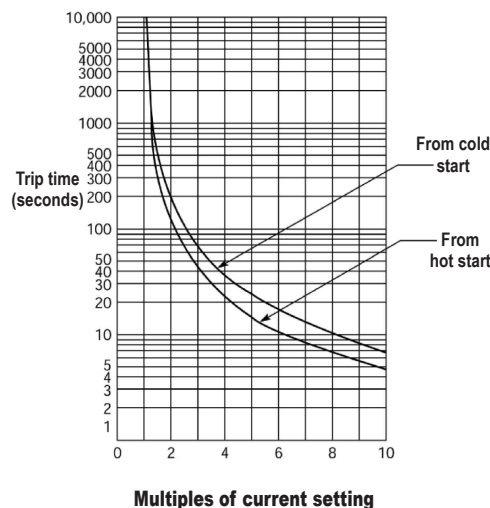

## Overload terminals 95/96 and 98/97

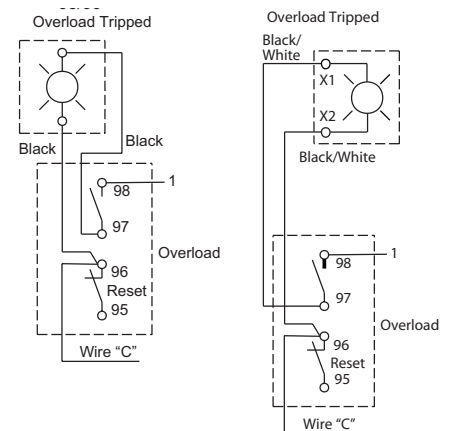

**Warning:** To provide continued protection against fire or shock hazard, the complete relay must be replaced if burnout of the heater element occurs.



# Motor Control Accessories

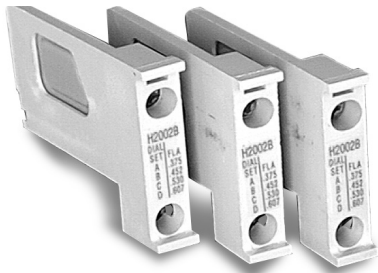

## Heater packs

Heater packs are used with the C306DN3B overload relay. The load lugs are built into the overload base to allow load wiring prior to heater pack installation. Heater packs come in packs of three.

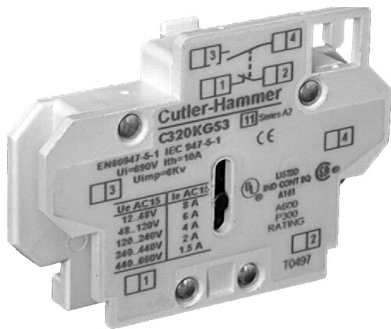

## Auxiliary contacts

Auxiliary contacts are designed for installation on the Cutler-Hammer Freedom series contactors and starters. The snap-on design makes them quick and easy to install.

The bifurcated (i.e. contact is split into two fingers for redundant contact) design of the contact blocks features silver cadmium alloy contacts.

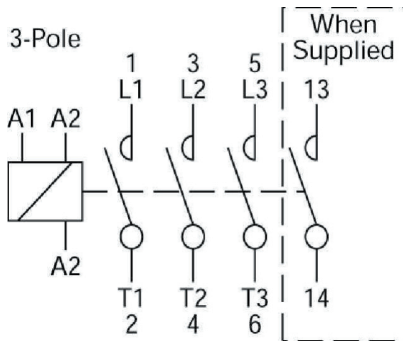

Auxiliary Contacts

| Standard Trip-Class 20 Heater Packs |          |           |   |      |      |      |
|-------------------------------------|----------|-----------|---|------|------|------|
| Part Number<br>(Three heater packs) | Price    | Max. Amps | Motor Full Load Ampere Rating Dial Position |      |      |      |
|                                     |          |           | A   | B    | C    | D    |
| <a href="#">H2001B-3</a>            | \$140.00 | 32        | .254  | .306 | .359 | .411 |
| <a href="#">H2002B-3</a>            | \$140.00 | 32        | .375  | .452 | .530 | .607 |
| <a href="#">H2003B-3</a>            | \$140.00 | 32        | .560  | .676 | .791 | .907 |
| <a href="#">H2004B-3</a>            | \$140.00 | 32        | .814  | .983 | 1.15 | 1.32 |
| <a href="#">H2005B-3</a>            | \$140.00 | 32        | 1.20  | 1.45 | 1.71 | 1.96 |
| <a href="#">H2006B-3</a>            | \$140.00 | 32        | 1.79  | 2.16 | 2.53 | 2.90 |
| <a href="#">H2007B-3</a>            | \$140.00 | 32        | 2.15  | 2.60 | 3.04 | 3.49 |
| <a href="#">H2008B-3</a>            | \$140.00 | 32        | 3.23  | 3.90 | 4.56 | 5.23 |
| <a href="#">H2009B-3</a>            | \$140.00 | 32        | 4.55  | 5.50 | 6.45 | 7.40 |
| <a href="#">H2010B-3</a>            | \$140.00 | 32        | 6.75  | 8.17 | 9.58 | 11.0 |
| <a href="#">H2011B-3</a>            | \$140.00 | 32        | 9.14  | 10.8 | 12.4 | 14.0 |
| <a href="#">H2012B-3</a>            | \$140.00 | 32        | 14.0  | 16.9 | 19.9 | 22.8 |
| <a href="#">H2013B-3</a>            | \$140.00 | 32        | 18.7  | 22.7 | 26.7 | 30.7 |
| <a href="#">H2014B-3</a>            | \$140.00 | 32        | 23.5  | 28.5 | 33.5 | 38.5 |

## Contactors terminal markings

Contactors terminals are identified by a two-digit number in accordance with international standards approved by CENELEC (European Committee for Electrotechnical Standardization). This distinctive number is marked on the top nameplate and designates the type and quantity of built-in auxiliary contacts. The first digit indicates the quantity of N.O. contacts and the second digit indicates the quantity of N.C. contacts. Example: 10E indicates a contactor with one N.O. and no N.C. auxiliary contacts (factory supplied). In addition, all terminals conform to both CENELEC and NEMA requirements. Auxiliary contact terminals use the first digit to indicate location and the second digit to indicate status (1-2 means N.C. and 3-4 means N.O.) Example: 13-14 indicates the first auxiliary contact and it is a N.O. See the diagram to the left for the contact label.

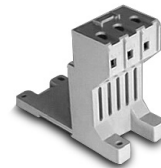

## Mounting adapters

DIN-rail and panel mounting adapters are required when overload relays need to be separately mounted due to space requirements. The terminal base adapter includes line terminals and connects with the overload relays.

| Mounting Adapters       |         |   |
|-------------------------|---------|---|
| Part Number             | Price   | Description                             |
| <a href="#">C306TB1</a> | \$44.50 | Mounting Adapter for 32A Overload Relay |

| Auxiliary Contacts       |          |                   |
|--------------------------|----------|-------------------|
| Part Number              | Price    | Description       |
| <a href="#">C320KGS3</a> | \$100.00 | 1 N.O. and 1 N.C. |
| <a href="#">C320KGS1</a> | \$72.00  | 1 N.O.            |