

CLICK PLUS Option Slot Module Specifications

C2-08D2-6C

\$90.00

**4 DC Input / 4 Sourcing DC Output
4 Analog Current Input
2 Analog Current Output
Option Slot I/O Module**



NOTE: Use this module and a CLICK PLUS CPU as a comparable replacement for the existing [C0-12DD2E-1-D](#) PLC.

Wiring Diagram

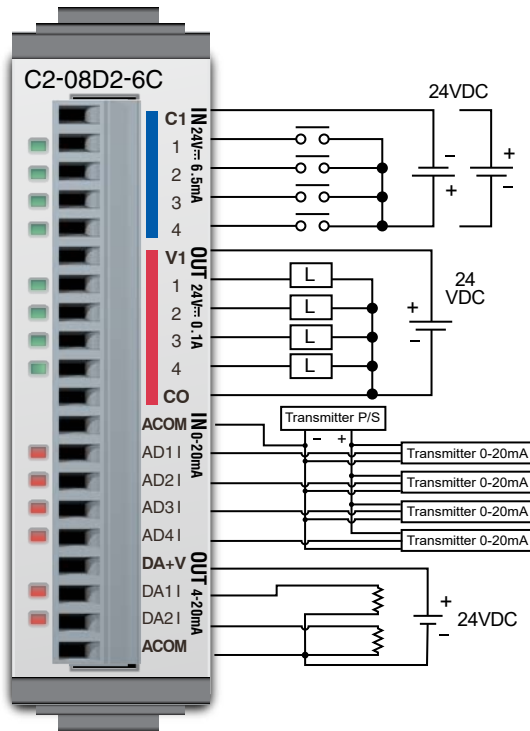

← **See Discrete I/O Specifications
Inputs (X1 – X4) High-Speed**

← **See Discrete I/O Specifications
Outputs (Y1 – Y4)
Y1 and Y3 Outputs High-Speed**

← **See Analog I/O Specifications
Current Inputs (AD1I – AD4I)**

← **See Analog I/O Specifications
Current Outputs (DA1I – DA2I)**



NOTE: There are no **ZIPLink** pre-wired PLC connection cables and modules for the Analog Option Slot Modules (cannot mix discrete I/O and analog I/O signals in a **ZIPLink** cable).

General Specifications	
Current Consumption at 24VDC	80mA max (All Points On)
Terminal Block Replacement Part No.	C0-16TB
Drawing Link	PDF
Weight	48g

CLICK PLUS Option Slot Module Specifications

C2-08D2-6C (cont'd)

X1 - X4 (High-Speed)

Discrete I/O Specifications - Inputs	
Inputs per Module	4 (Sink/Source)
Operating Voltage Range	24VDC
Input Voltage Range	21.6–26.4 VDC
Input Current	Typ 6.5 mA @ 24VDC
Maximum Input Current	7mA @ 26.4 VDC
Input Impedance	3.9 kΩ @ 24VDC
Input Frequency (Max)	X1-X4: 100kHz (3m cable)
ON Voltage Level	> 19VDC
OFF Voltage Level	< 2VDC
Minimum ON Current	4.5 mA
Maximum OFF Current	0.5 mA
OFF to ON Response	Typ 3μs, Max 5μs
ON to OFF Response	Typ 1μs, Max 3μs
Status Indicators	Logic Side (4 points, green LED)
Commons	1 (4 points/common)

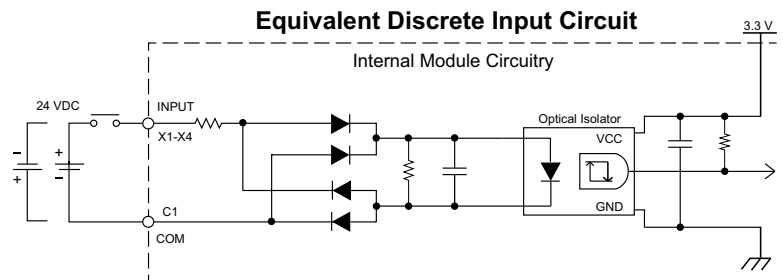

Maximum Number of High Speed Counters	
Up	4
Down	4
Up/Down	2
Pulse/Direction	2
Quadrature A-B	2
Quadrature A-B+Z	1

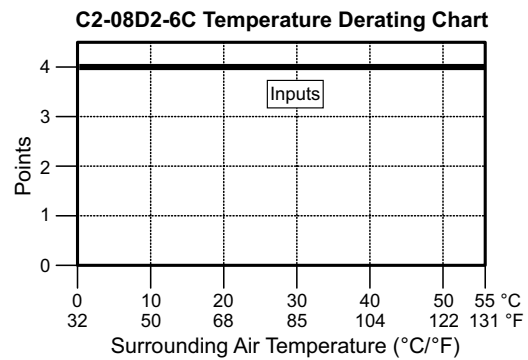

Y1 - Y4

Discrete I/O Specifications - Outputs	
Outputs per Module	4 (Source)
Output Voltage Range	19.2–30 VDC
Maximum Output Current	0.1 A/point, 0.4 A/common CO
Minimum Output Current	0.2 mA
Maximum Leakage Current	0.1 mA @ 30VDC
On Voltage Drop	0.5 VDC @ 0.1 A
Maximum Inrush Current	150mA for 10ms
Output Frequency (Max)	Y1, Y3: 100kHz (3m cable)
OFF to ON Response	< 5μs
ON to OFF Response	< 5μs
Status Indicators	Logic Side (4 points, red LED)
Commons	1 (4 points/common)
External DC Power Required	20–28 VDC Maximum @ 60mA (All points on)

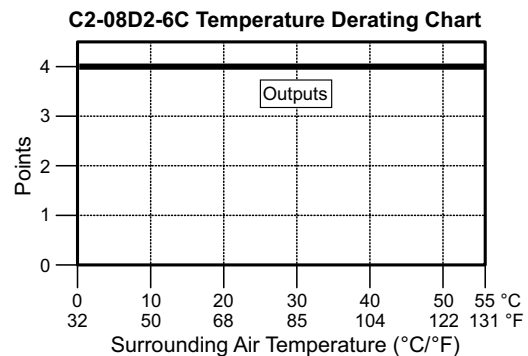
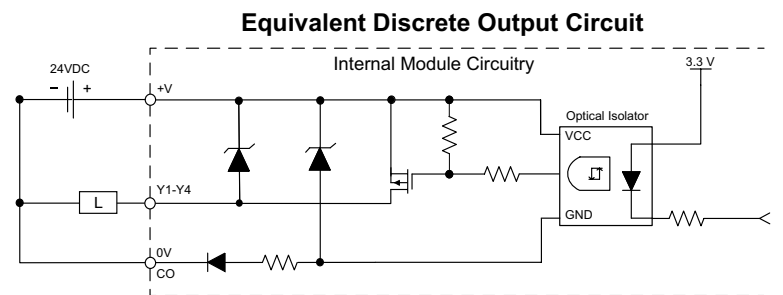

Maximum Number of High Speed Outputs	
Pulse Train	2
Pulse Width Modulation	2

CLICK PLUS Option Slot Module Specifications

C2-08D2-6C (cont'd)

AD1I - AD4I

Analog Specifications - Current Input	
Inputs per Module	4 (current)
Input Range	0–20 mA (sink)
Resolution	12-bit
Conversion Time	50ms
Input Impedance	125Ω
Input Stability	±2 LSB maximum
Full-Scale Calibration Error	±2% maximum
Offset Calibration Error	±0.1 mA maximum
Accuracy vs. Temperature Error	±100ppm/°C maximum

Analog Current Input Circuit

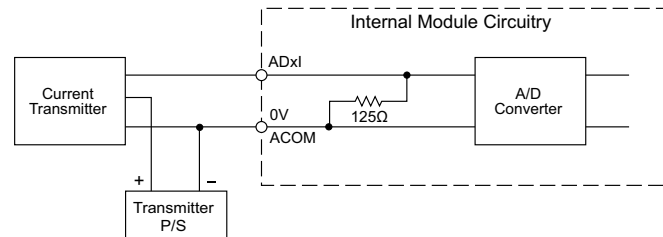

DA1I - DA2I

Analog Specifications - Current Output	
Outputs per Module	2 (current)
Output Range	4–20 mA (source)
Resolution	12-bit
Conversion Time	2.5 ms
Load Impedance	250Ω TYP (200–800 Ω)
Loop Supply Voltage	DC 24V TYP (21.6–26.4 VDC)
Full-Scale Calibration Error	±2% maximum
Offset Calibration Error	±25mA maximum
Accuracy vs. Temperature Error	±100ppm/°C maximum
External DC Power Required	21.6–26.4 VDC

Analog Current Output Circuit

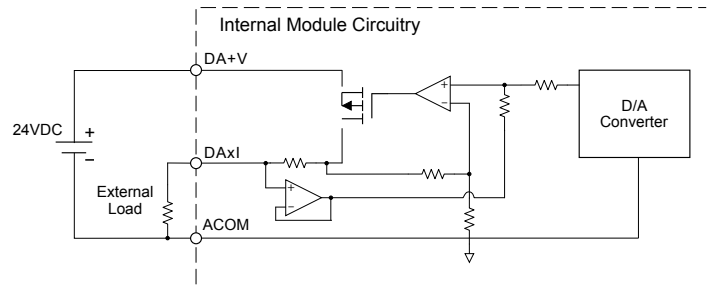

CLICK PLUS Option Slot Module Specifications

General Specifications For All CLICK PLUS Option Slot Modules

These general specifications apply to all CLICK PLUS Option Slot Modules. Please refer to the appropriate I/O temperature derating charts under the Option Slot module and Stackable I/O module specifications to determine the best operating conditions based on the ambient temperature of your particular application.

Option Slot Module General Specifications	
Operating Temperature	32°F to 131°F [0°C to 55°C]
Storage Temperature	-4°F to 158°F [-20°C to 70°C] IEC 60068-2-1 (Test Ab, Cold) IEC 60068-2-2 (Test Bb, Dry Heat) IEC 60068-2-14 (Test Na, Thermal Shock)
Ambient Humidity	30% to 95% relative humidity (non-condensing)
Environmental Air	No corrosive gases. Environmental pollution level is 2 (UL840)
Environment	For Indoor Use Only
Vibration	IEC60068-2-6 (Test Fc) 5-9Hz:3.5mm amplitude, 9-150Hz 1.0G 10 sweep cycles per axis on each of 3 mutually perpendicular axes.
Shock	IEC60068-2-27 (Test Ea) 15G peak, 11ms duration, 3 shocks in each direction per axis, on 3 mutually perpendicular axes.
Noise Immunity	<EN61131-2> EN61000-4-2 (ESD) EN61000-4-3 (RFI) EN61000-4-4 (FTB) EN61000-4-6 (Conducted) EN61000-4-8 (Power frequency magnetic field immunity) <Local Test> Impulse Immunity : 1000V @ 1uS pulse
Emissions	EN55011 Class A (Radiated RF emission)
Agency Approvals	UL61010 (File No. E157382, E316037); CE (EN61131-2); CUL Canadian C22.2
Other	RoHS 2011/65/EU Amendment (EU)2015/863

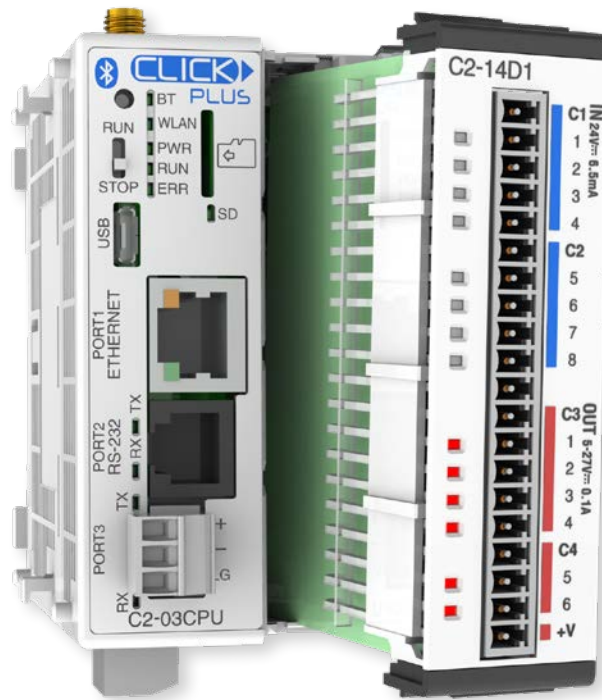

CLICK PLUS PLC Specifications

CLICK PLUS PLC Hardware/Software Compatibility

The table below shows the minimum software and hardware versions required for the CLICK PLUS PLCs and Option Slot Modules. The CLICK PLUS PLC can also utilize the CLICK Stackable I/O Modules, as any software and hardware version compatible with CLICK PLUS is also compatible with the CLICK Stackable I/O Modules.

CLICK PLUS PLC Features Software Compatibility						
Device Type	Part Number	Minimum CLICK Software Version				
		Hardware	High-Speed Inputs*	High-Speed Outputs*	EtherNet/IP	PID, DHCP, DNS, SNTP, MQTT
CLICK PLUS CPU	C2-01CPU	v3.00	v3.00	v3.30	v3.00	v3.00
	C2-02CPU				N/A	
	C2-03CPU				v3.00	
	C2-01CPU-2	v3.20	v3.20	v3.20	v3.20	v3.20
	C2-02CPU-2				N/A	
	C2-03CPU-2				v3.20	
Option Slot I/O Modules	C2-14D1	v3.00	v3.00	v3.30	N/A	N/A
	C2-14D2			N/A		
	C2-14DR					
	C2-14AR					
	C2-08D1-4VC	v3.00	v3.00	v3.30	N/A	N/A
	C2-08D2-4VC			N/A		
	C2-08DR-4VC					
	C2-08AR-4VC					
	C2-08D1-6C	v3.00	v3.00	v3.30	N/A	N/A
	C2-08D2-6C			N/A		
	C2-08DR-6C					
	C2-08AR-6C					
	C2-08D1-6V	v3.00	v3.00	v3.30	N/A	N/A
	C2-08D2-6V			N/A		
	C2-08DR-6V					
	C2-08AR-6V					
Option Slot Intelligent Modules	C2-DCM	v3.20	N/A	N/A	N/A	N/A

* High-speed Inputs and Outputs are only available when the Option Slot I/O Module is installed in Slot 0.

Accessories

C2-USER-M **\$0.00** **CLICK PLUS PLC Hardware User Manual**

Manual covers all CLICK PLUS PLC and I/O module installation and wiring, specifications, error codes and troubleshooting guide. The CLICK PLUS PLC Hardware User Manual can be downloaded free at the AutomationDirect Web site; www.AutomationDirect.com



C0-USER-M **\$0.00** **CLICK PLC Hardware User Manual**

Manual covers all CLICK PLC and I/O module installation and wiring, specifications, error codes and troubleshooting guide. The CLICK PLC Hardware User Manual can be downloaded free at the AutomationDirect Web site; www.AutomationDirect.com



C0-PGMSW **\$12.00** **Programming Software USB**

The programming software can be downloaded free at the AutomationDirect Web site, or the USB can be purchased from the AutomationDirect online Web store. www.AutomationDirect.com



EA-MG-PGM-CBL **\$52.00** **PC to Panel Programming Cable Assembly for C-more Micro-Graphic Panels and CLICK/CLICK PLUS PLCs**

The 6-ft cable assembly connects a personal computer to any **C-more** Micro-Graphic panel, CLICK PLC, or select CLICK PLUS PLC for setup and programming.

Note: This cable assembly uses the PC's USB port and converts the signals to serial transmissions. The USB port supplies 5VDC to the Micro-Graphic panel for configuration operations.

Assembly includes standard USB A-type connector to B-type connector cable, custom converter, and an RS232C cable with an RJ12 modular connector on each end.



USB-CBL-AMICB6 **\$5.25** **USB A to USB microB Programming Cable Assembly (CLICK PLUS Only)**

Programming cable, USB A to USB microB, 6ft (1.83 m) length. For use with CLICK PLUS PLCs and most USB devices. The USB port supplies 5VDC to the CLICK PLUS CPU for programming.



D2-DSCBL **\$35.00** **Programming Cable for CLICK/CLICK PLUS and DirectLOGIC PLCs**

12ft. (3.66 m) RS232 shielded PC programming cable for CLICK, select CLICK PLUS PLCs, DL05, DL06, DL105, DL205, D3-350, D4-450, D4-454, and Do-more H2 and T1H series CPUs. 9-pin D-shell female connector to an RJ12 6P6C connector.



Note: If your PC has a USB port but does not have a serial port, you must use programming cable EA-MG-PGM-CBL to connect to CLICK PLCs. For CLICK PLUS PLCs, you may also use USB-CBL-AMICB6

C0-3TB **\$10.00** **Spare 3-Pole Terminal Block**

Replacement 3-pole terminal block for the 3-wire RS-485 Port 3 on CLICK Standard and Analog PLCs as well as the CLICK PLUS [C2-03CPU](#). Sold in packs of 2.



C0-4TB **\$10.00** **Spare 24VDC Power Terminal Block**

Replacement terminal block for the 24VDC supply power to the PLC. Sold in packs of 2.

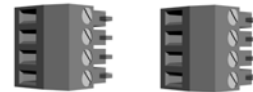

C0-8TB **\$16.50** **Spare 8-Point I/O Terminal Block**

Replacement terminal block for the 8-point I/O modules. Sold in packs of 2.

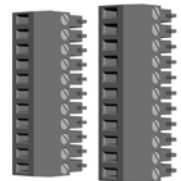

C0-8TB-1 **\$19.50** **Spare 13-Point I/O Terminal Block**

Replacement terminal block for the 8-point I/O relay modules. Sold in packs of 2.



C0-16TB **\$23.00** **Spare 16-Point I/O Terminal Block**

Replacement terminal block for the 16-point I/O modules and PLC built-in I/O. Sold in packs of 2.

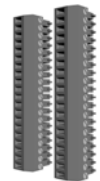

C2-6TB **\$16.50** **Spare 6-pt Terminal Block**

Replacement terminal block for the C2-DCM serial ports. Sold in packs of 2.

