

# Ethernet Analog PLC

**C0-12DD1E-D**     **\$253.00**

**4 DC Input (Sink/Source)/4 Sinking DC Output;  
2 Analog Voltage/Current Input  
2 Analog Voltage/Current Output Micro PLC**

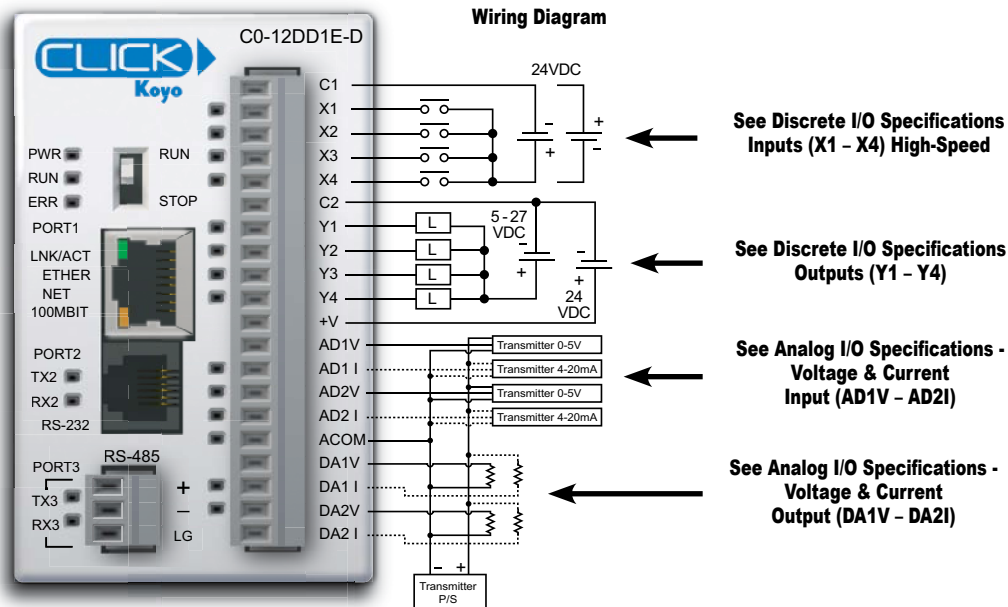

**NOTE:** There are no **ZIP**Link pre-wired PLC connection cables and modules for the Analog PLCs (cannot mix discrete I/O and analog I/O signals in a **ZIP**Link cable).  
**NOTE:** When using Ethernet Analog PLCs, you must use CLICK programming software version V2.20 or later.



**IMPORTANT:** USE ONLY ONE TERMINAL (VOLTAGE OR CURRENT) PER CHANNEL. YOU MUST ALSO SELECT THE ANALOG TYPE (VOLTAGE OR CURRENT) IN THE CPU BUILT-IN I/O SETUP IN THE CLICK PROGRAMMING SOFTWARE (PULL-DOWN MENU SETUP > CPU BUILT-IN I/O SETUP).

General Specifications	
Current Consumption at 24VDC	140mA
Terminal Block Replacement Part No.	C0-16TB
Drawing Link	PDF
Weight	5.1 oz [145g]

# Ethernet Analog PLC

## C0-12DD1E-D (cont'd)

### X1 - X4 (High-Speed)

Discrete I/O Specifications - Inputs	
<b>Inputs per Module</b>	4 (Sink/Source)
<b>Operating Voltage Range</b>	24VDC
<b>Input Voltage Range</b>	21.6–26.4 VDC
<b>Input Current</b>	Typ 6.5 mA @ 24VDC
<b>Maximum Input Current</b>	7.0 mA @ 26.4 VDC
<b>Input Impedance</b>	3.9 kΩ @ 24VDC
<b>Input Frequency (Max)</b>	X1-X4: 100kHz
<b>ON Voltage Level</b>	> 19VDC
<b>OFF Voltage Level</b>	< 2VDC
<b>Minimum ON Current</b>	4.5 mA
<b>Maximum OFF Current</b>	0.5 mA
<b>OFF to ON Response</b>	Typ 3μs Max 5μs
<b>ON to OFF Response</b>	Typ 1μs Max 3μs
<b>Status Indicators</b>	Logic Side (4 points, green LED)
<b>Commons</b>	1 (4 points/common)

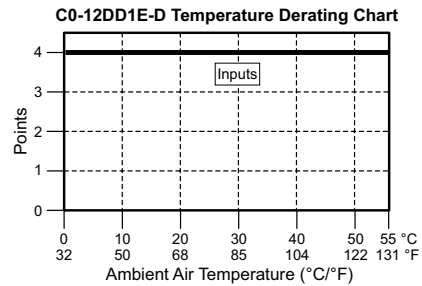
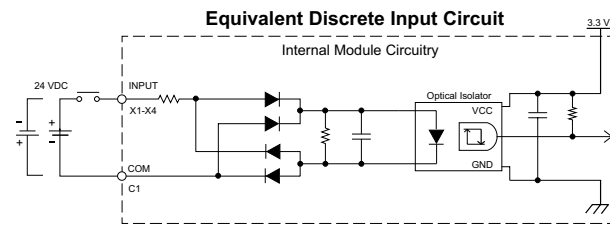

### Y1 - Y4

Discrete I/O Specifications - Outputs	
<b>Outputs per Module</b>	4 (Sink)
<b>Operating Voltage Range</b>	5–27 VDC
<b>Maximum Output Current</b>	0.1 A/point; 0.4 A/common
<b>Minimum Output Current</b>	0.2 mA
<b>Maximum Leakage Current</b>	0.1 mA @ 30.0 VDC
<b>On Voltage Drop</b>	0.5 VDC @ 0.1 A
<b>Maximum Inrush Current</b>	150mA for 10ms
<b>OFF to ON Response</b>	< 5μs
<b>ON to OFF Response</b>	< 5μs
<b>Status Indicators</b>	Logic Side (4 points, red LED)
<b>Commons</b>	1 (4 points/common)
<b>External DC Power Required</b>	20–28 VDC Maximum @ 60mA (all points on)

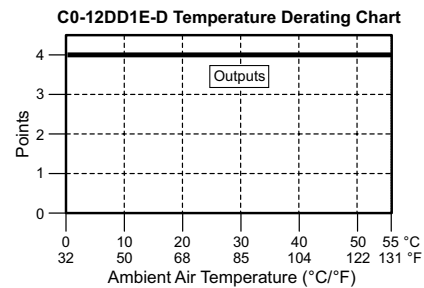
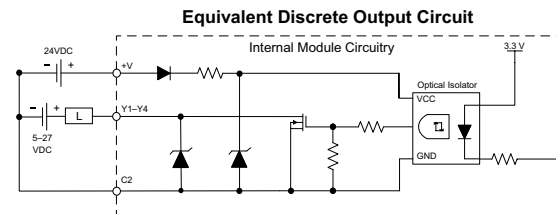

# Ethernet Analog PLC

## C0-12DD1E-D (cont'd)

### AD1V - AD2V

Analog Specifications - Voltage Input	
<b>Inputs per Module</b>	2 (voltage/current selectable)
<b>Input Range</b>	0-5 VDC (6VDC Max.)
<b>Resolution</b>	12-bit
<b>Conversion Time</b>	50ms
<b>Input Impedance</b>	20kΩ
<b>Input Stability</b>	±2 LSB maximum
<b>Full-Scale Calibration Error</b>	±2% maximum
<b>Offset Calibration Error</b>	±25mV maximum
<b>Accuracy vs. Temperature Error</b>	±100ppm / °C maximum

Analog Voltage Input Circuit

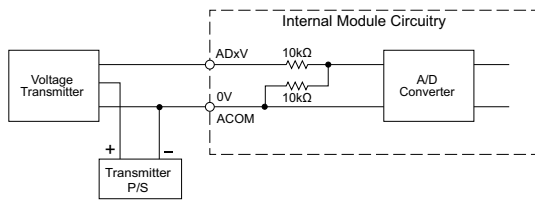

### AD1I - AD2I

Analog Specifications - Current Input	
<b>Inputs per Module</b>	2 (voltage/current selectable)
<b>Input Range</b>	4-20 mA (sink)
<b>Resolution</b>	12-bit
<b>Conversion Time</b>	50ms
<b>Input Impedance</b>	125Ω
<b>Input Stability</b>	±2 LSB
<b>Full-Scale Calibration Error</b>	±2% maximum
<b>Offset Calibration Error</b>	±0.1 mA maximum
<b>Accuracy vs. Temperature Error</b>	±100ppm / °C maximum

Analog Current Input Circuit

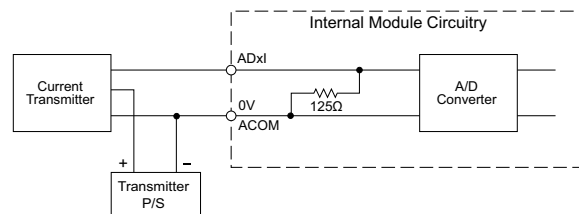

### DA1V - DA2V

Analog Specifications - Voltage Output	
<b>Outputs per Module</b>	2 (voltage/current selectable)
<b>Output Range</b>	0-5 VDC
<b>Resolution</b>	12-bit
<b>Conversion Time</b>	1ms
<b>Load Impedance</b>	2kΩ minimum (output current 2.5 mA maximum)
<b>Full-Scale Calibration Error</b>	±2% maximum
<b>Offset Calibration Error</b>	±25mV maximum
<b>Accuracy vs Temperature Error</b>	±100ppm / °C maximum

Analog Voltage Output Circuit

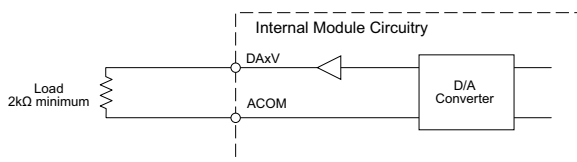

### DA1I - DA2I

Analog Specifications - Current Output	
<b>Outputs per Module</b>	2 (voltage/current selectable)
<b>Output Range</b>	4-20 mA (sink)
<b>Resolution</b>	12-bit
<b>Conversion Time</b>	1ms
<b>Loop Supply Voltage</b>	DC 18-30 V
<b>Load Impedance</b>	250 ohms Load Power Supply: DC 18V: 600Ω maximum DC 24V: 900Ω maximum DC 30V: 1200Ω maximum
<b>Full-Scale Calibration Error</b>	±2% maximum
<b>Offset Calibration Error</b>	±25mA maximum
<b>Accuracy vs Temperature Error</b>	±100ppm / °C maximum

Analog Current Output Circuit

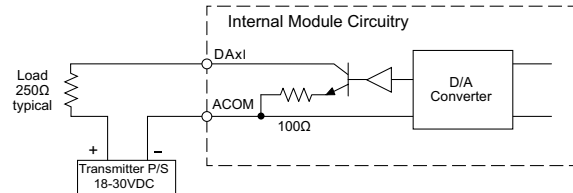

# CLICK PLC Specifications

## General Specifications For All CLICK PLC Products

These general specifications apply to all CLICK PLCs and optional power supply products. Please refer to the appropriate I/O temperature derating charts under both the PLC and I/O module specifications to determine best operating conditions based on the ambient temperature of your particular application.

General Specifications	
<b>Operating Temperature</b>	Analog, analog combo I/O modules only: 32°F to 140°F [0°C to 60°C]; All other modules: 32°F to 131°F [0°C to 55°C], IEC 60068-2-14 (Test Nb, Thermal Shock)
<b>Storage Temperature</b>	-4°F to 158°F [-20°C to 70°C] IEC 60068-2-1 (Test Ab, Cold) IEC 60068-2-2 (Test Bb, Dry Heat) IEC 60068-2-14 (Test Na, Thermal Shock)
<b>Ambient Humidity</b>	30% to 95% relative humidity (non-condensing)
<b>Environmental Air</b>	No corrosive gases. Environmental pollution level is 2 (UL840)
<b>Vibration</b>	MIL STD 810C, Method 514.2, EC60068-2-27, Category [f], Procedure[VIII] JIS C60068-2-27 (Sine wave vibration test)
<b>Shock</b>	MIL STD 810C, Method 516.2, IEC60068-2-27, JIS C60068-2-27, Category [f], Procedure[VIII]
<b>Noise Immunity</b>	<EN61131-2> EN61000-4-2 (ESD) EN61000-4-3 (RFI) EN61000-4-4 (FTB) EN61000-4-5 (Surge) EN61000-4-6 (Conducted) EN61000-4-8 (Power frequency magnetic field immunity)  <Local Test> Impulse noise 1µs, 1000V RFI: No interference measured at 150 and 450 MHz (5w/15cm)
<b>Emissions</b>	EN55011:1998 Class A; EN61000-6-4:2007+A1:2011
<b>Agency Approvals</b>	UL508, UL61010-2-201 (File No. E157382, E316037); CE (EN61131-2); CUL Canadian C22.2
<b>Other</b>	RoHS 2011/65/EU Amendment (EU)2015/863

# CLICK PLC Specifications

## PLC Unit Specifications

Ethernet Basic, Standard and Analog PLC Unit Specifications			
	<i>Ethernet Basic PLC</i>	<i>Ethernet Standard PLC</i>	<i>Ethernet Analog PLC</i>
<b>Control Method</b>	Stored Program/Cyclic execution method	Stored Program/Cyclic execution method	Stored Program/Cyclic execution method
<b>I/O Numbering System</b>	Fixed in Decimal	Fixed in Decimal	Fixed in Decimal
<b>Ladder Memory (steps)</b>	8000	8000	8000
<b>Total Data Memory (words)</b>	8000	8000	8000
<b>Contact Execution (Boolean)</b>	< 0.2 $\mu$ s	< 0.2 $\mu$ s	< 0.2 $\mu$ s
<b>Typical Scan (1K Boolean)</b>	< 1ms	< 1ms	< 1ms
<b>RLL Ladder Style Programming</b>	Yes	Yes	Yes
<b>Run Time Edits</b>	Yes	Yes	Yes
<b>Scan</b>	Variable / fixed	Variable / fixed	Variable / fixed
<b>CLICK Programming Software for Windows</b>	Yes	Yes	Yes
<b>Built-in Communication Ports</b>	Yes (one Ethernet port and one RS-232 port)	Yes (one Ethernet port, one RS-232 port and one RS-485 port)	Yes (one Ethernet port, one RS-232 port and one RS-485 port)
<b>Protocols</b>	Modbus RTU (master/slave) and ASCII (in/out), Modbus TCP (client/server), EtherNet/IP Implicit and Explicit (adapter server)		
<b>FLASH Memory</b>	Standard on PLC	Standard on PLC	Standard on PLC
<b>Built-in Discrete I/O points</b>	8 inputs, 6 outputs	8 inputs, 6 outputs	4 inputs, 4 outputs
<b>Built-in Analog I/O Channels</b>	No	No	2 or 4 inputs; 2 outputs
<b>Number of High-Speed Input Points</b>	4	8	4
<b>Number of High-Speed Counters</b>	4	6	4
<b>PID Control Loops</b>	8	8	8
<b>Number of Instructions Available</b>	21	21	21
<b>Control Relays</b>	2000	2000	2000
<b>System Control Relays</b>	1000	1000	1000
<b>Timers</b>	500	500	500
<b>Counters</b>	250	250	250
<b>Interrupts</b>	Yes (external: 8 / timed: 4)	Yes (external: 8 / timed: 4)	Yes (external: 4 / timed: 4)
<b>Subroutines</b>	Yes	Yes	Yes
<b>For/Next Loops</b>	Yes	Yes	Yes
<b>Math (Integer and Hex)</b>	Yes	Yes	Yes
<b>Drum Sequencer Instruction</b>	Yes	Yes	Yes
<b>Internal Diagnostics</b>	Yes	Yes	Yes
<b>Password Security</b>	Yes	Yes	Yes
<b>System Error Log</b>	Yes	Yes	Yes
<b>User Error Log</b>	No	No	No
<b>Memory Backup</b>	Super Capacitor + Battery	Super Capacitor + Battery	Super Capacitor + Battery
<b>Battery Backup</b>	Yes (battery part # <a href="#">D2-BAT-1</a> )	Yes (battery part # <a href="#">D2-BAT-1</a> )	Yes (battery part # <a href="#">D2-BAT-1</a> )
<b>Calendar/Clock</b>	Yes	Yes	Yes
<b>I/O Terminal Block Replacement</b>	AutomationDirect p/n <a href="#">C0-16TB</a>	AutomationDirect p/n <a href="#">C0-16TB</a>	AutomationDirect p/n <a href="#">C0-16TB</a>
<b>Communication Port &amp; Terminal Block Replacement</b>	N/A	AutomationDirect p/n <a href="#">C0-3TB</a>	AutomationDirect p/n <a href="#">C0-3TB</a>
<b>24VDC Power Terminal Block Replacement</b>	AutomationDirect p/n <a href="#">C0-4TB</a>	AutomationDirect p/n <a href="#">C0-4TB</a>	AutomationDirect p/n <a href="#">C0-4TB</a>

# CLICK Specifications

## CLICK PLC Hardware/Software Compatibility

CLICK PLCs require a minimum software version of v2.50 for the PID function. The table below shows the most recent software and hardware versions required for the High-Speed input operation capability to be accessible.

CLICK PLC Features Software Compatibility							
CPU Type	Part Number	Minimum CLICK Software Version					
		Hardware	High-Speed Inputs	EtherNet/IP	PID	DHCP	
<b>Basic</b>	<a href="#">C0-00DD1-D</a>	v1.00	N/A	N/A	N/A	N/A	
	<a href="#">C0-00DD2-D</a>						
	<a href="#">C0-00DR-D</a>						
	<a href="#">C0-00AR-D</a>						
<b>Standard</b>	<a href="#">C0-01DD1-D</a>	v1.20	N/A	N/A	N/A	N/A	
	<a href="#">C0-01DD2-D</a>						
	<a href="#">C0-01DR-D</a>						
	<a href="#">C0-01AR-D</a>						
<b>Analog</b>	<a href="#">C0-02DD1-D</a> (before SN 171208001)	v1.12	N/A	N/A	N/A	N/A	
	<a href="#">C0-02DD1-D</a> (after SN 171208001)	v2.10					
	<a href="#">C0-02DD2-D</a> (before SN 174018001)	v1.12					
	<a href="#">C0-02DD2-D</a> (after SN 174018001)	v2.10					
	<a href="#">C0-02DR-D</a> (before SN 173158001)	v1.12					
	<a href="#">C0-02DR-D</a> (after SN 173158001)	v2.10					
<b>Ethernet CPUs</b>	Ethernet CPUs require v2.40 for EtherNet/IP communications						
<b>Ethernet Basic</b>	<a href="#">C0-10DD1E-D</a>	v2.00	v2.30	v2.40	v2.50	v3.00	
	<a href="#">C0-10DD2E-D</a>						
	<a href="#">C0-10DRE-D</a>		N/A				
	<a href="#">C0-10ARE-D</a>						
<b>Ethernet Standard</b>	<a href="#">C0-11DD1E-D</a>	v2.00	v2.30	v2.40	v2.50	v3.00	
	<a href="#">C0-11DD2E-D</a>						
	<a href="#">C0-11DRE-D</a>		N/A				
	<a href="#">C0-11ARE-D</a>						
<b>Ethernet Analog</b>	<a href="#">C0-12DD1E-D</a>	v2.20	v2.30	v2.40	v2.50	v3.00	
	<a href="#">C0-12DD2E-D</a>						
	<a href="#">C0-12DRE-D</a>		N/A				
	<a href="#">C0-12ARE-D</a>						
	<a href="#">C0-12DD1E-1-D</a>		v2.30				
	<a href="#">C0-12DD2E-1-D</a>						
	<a href="#">C0-12DRE-1-D</a>		N/A				
	<a href="#">C0-12ARE-1-D</a>						
	<a href="#">C0-12DD1E-2-D</a>		v2.30				
	<a href="#">C0-12DD2E-2-D</a>						
	<a href="#">C0-12DRE-2-D</a>		N/A				
	<a href="#">C0-12ARE-2-D</a>						
<b>I/O Modules</b>	<a href="#">C0-08NE3</a>	v1.20	N/A	N/A	N/A	N/A	
	<a href="#">C0-16NE3</a>						
	<a href="#">C0-04AD-1</a>	v1.40					
	<a href="#">C0-04AD-2</a>						
	<a href="#">C0-04DA-1</a>						
	<a href="#">C0-04DA-2</a>						
	<a href="#">C0-4AD2DA-1</a>						
	<a href="#">C0-4AD2DA-2</a>						
	<a href="#">C0-04RTD</a>						
	<a href="#">C0-04THM</a>						
	<a href="#">C0-08CDR</a>						
	<a href="#">C0-16CDD1</a>						
	<a href="#">C0-16CDD2</a>						
	Other modules						v1.00

# CLICK PLC Family Overview

## What you'll need

Of course, what you'll need for your system depends on your particular application, but this overview shows you what you'll need for a simple system.

### 1. Select your **CLICK** or **CLICK PLUS** PLC unit.



### 2. If using a **CLICK PLUS** PLC, select an **Option Slot Module** if desired.

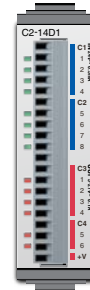

### 3. If you need additional I/O, select from 24 different types of **Stackable I/O modules**.



### 4. Select a 24VDC power supply.



or



### 5. Download the **FREE CLICK** programming software. [support.automationdirect.com/products/clickplcs.html](http://support.automationdirect.com/products/clickplcs.html)



### 6. Download the **FREE CLICK** mobile app. The **CLICK** mobile app is available for **iOS** and **Android**. It can connect to your **C2-02CPU** or **C2-03CPU** over **Bluetooth** to provision the PLC onto a **Wi-Fi** network. (PLC requires an external antenna)



# CLICK PLC Family Overview

## What you'll need (continued)

### 7. Select your PC-to-PLC programming cable.

If your PC has a USB port, use cable [EA-MG-PGM-CBL](#) to connect to the PLC port. If your PC has a 9-pin serial communications port, use programming cable [D2-DSCBL](#). If your PC has an Ethernet port, use [C5E-STPYL-C3](#) (crossover) or [C5E-STPYL-S3](#) (straight through) Ethernet cable. If your PC is on a network with a wireless access point, you can connect using one of our Wi-Fi antennas.

**[USB-CBL-AMICB6](#)**



**USB A to USB microB  
Programming Cable Assembly  
(CLICK PLUS Only)**

**[C5E-STPYL-C3](#) (crossover)  
[C5E-STPYL-S3](#) (straight through)**



**For Ethernet PLC Unit**

**OR**

**[SE-ANT250](#)  
Wi-Fi/Bluetooth Dome Antenna  
([C2-02CPU](#) & [C2-03CPU](#) only)**



**OR**

**[SE-ANT210](#)  
Wi-Fi/Bluetooth Whip Antenna  
([C2-02CPU](#) & [C2-03CPU](#) only)  
(nonmetal enclosure only)**



**[D2-DSCBL](#)**



**(PC requires RS-232 port  
to use this cable)**

**OR**

**[EA-MG-PGM-CBL](#)**



**Connects to PC USB Port**

### 8. Select tools, wire, and provide power.

**Screwdriver  
[TW-SD-MSL-2](#)**



**Wire Strippers  
[DN-WS](#)**



**Hookup Wire**





# Power Supplies

## Power Supplies

The CLICK PLC family offers two 24VDC power supplies. They are identical except for the output current.

It is not mandatory to use one of these CLICK power supplies for the CLICK/CLICK PLUS PLC system. You can use any other 24VDC power supply that AutomationDirect.com offers, including the PSP24-DC12-1 12 to 24 VDC converter shown below.

### CO-00AC Power Supply

Limited auxiliary AC power supply allows you to power the 24VDC CLICK C0 and C2 series PLCs with 100–240 VAC supply power. The 0.5 A DC power supply is capable of controlling the PLC plus a limited configuration based on the power budget of each I/O module. The CO-00AC is a low-cost solution for applications requiring only minimal I/O and power consumption. This power supply will not support a fully-populated CLICK PLC system with all possible I/O module combinations.

### CO-01AC Power Supply

Expanded auxiliary AC power supply allows you to power the 24VDC CLICK C0 and C2 series PLCs with 100–240 VAC supply power. The 1.3 A DC power supply is capable of supporting a fully-populated CLICK PLC system with all possible I/O module combinations, with no concerns for exceeding the power budget.

### PSP24-DC12-1 DC-DC Converter

With this DC-DC converter you can operate the CLICK/CLICK PLUS PLC with 12VDC input power.

CO-00AC



CO-01AC

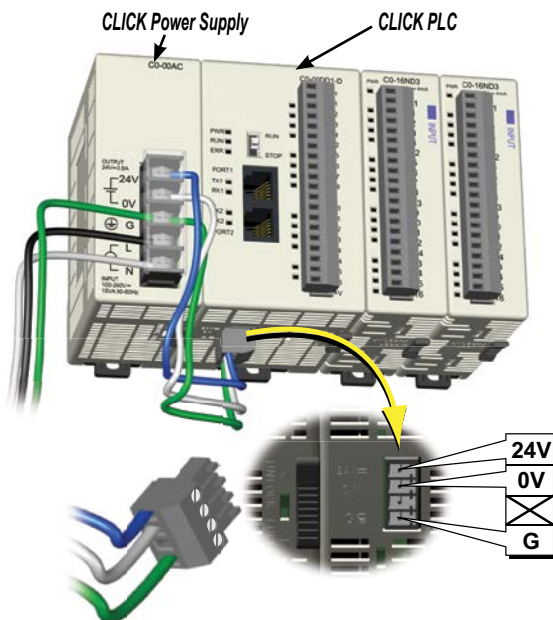

24VDC power is supplied to the PLC unit through wiring connected from the power supply output to the 4-pin 24VDC input connector located on the bottom of the PLC unit.

## CLICK 24VDC Power Supply Ratings

Part Number	Output Current	Price
CO-00AC	0.5 A	\$51.00
CO-01AC	1.3 A	\$63.00

## Power Supply Input Specifications

Part Number	CO-00AC	CO-01AC
Input Voltage Range	85–264 VAC	
Input Frequency	47–63 Hz	
Input Current (typical)	0.3 A @ 100VAC, 0.2 A @ 200VAC	0.9 A @ 100VAC, 0.6 A @ 200VAC
Inrush Current	30A	
Efficiency	80% typical	

## Power Supply Output Specs

Part Number	CO-00AC	CO-01AC
Output Voltage Range	23–25 VDC	
Output Current	0.5 A	1.3 A
Ripple	200mV p-p max (0–55°C)	
Ripple Noise	300mV p-p max (0–55°C)	
Over Current Protection	@ 0.65 A (automatic recovery)	@ 1.6 A (automatic recovery)
Over Voltage Protection	@ 27.6 V (clamped by Zener diode)	
Start-up Time	1000ms max at rated input and load	
Hold-up Time	10ms minimum at 85VAC, I=max	

## Power Supply General Specs

Part Number	CO-00AC	CO-01AC
Ambient Operating Temperature	32–131°F [0–55°C]	
Storage Temperature	–4–158°F [–20–70°C]	
Humidity	30–95%, non-condensing	
Vibration Resistance	JIS C60068-2-6, sine wave vibration	
Shock Resistance	JIS C60068-2-27	
Voltage Withstand	1500VAC, 5mA cutoff current	
Input-Output	1500VAC, 5mA cutoff current	
Input-Ground	500VAC, 5mA cutoff current	
Output-Ground	500VAC, 5mA cutoff current	
Insulation Resistance	10MΩ minimum, 500VDC	
Input-Output	10MΩ minimum, 500VDC	
Input-Ground	5MΩ minimum, 500VDC	
Output-Ground	5MΩ minimum, 500VDC	
Noise Immunity	FCC Class A, EN55022:1998 Class A	
Input/Output Interface	5P terminal block, Fujicon UF2362AX series or equivalent	
Agency Approvals	UL508, UL1604, EN61010-1 (IEC 1010-1), CAN/CSA E60079-15:02, JIS C0025	
Drawing Link	<a href="#">PDF</a>	<a href="#">PDF</a>
Weight	5.3 oz [150g]	6.0 oz [170g]



PSP24-DC12-1

## PSP24-DC12-1 DC-DC Converter Specs

Input Voltage Range	9.5–18 VDC
Input Power (no load)	1.0 W max.
Startup Voltage	8.4 VDC
Undervoltage Shutdown	7.6 VDC
Output Voltage Range	24–28 VDC (adjustable)
Output Current	1.0 A
Short Circuit Protection	Current limited at 110% typical
Drawing Link	<a href="#">PDF</a>
Weight	7.5 oz [213g]

# Accessories

## **C2-USER-M**     **\$0.00** **CLICK PLUS PLC Hardware User Manual**

Manual covers all CLICK PLUS PLC and I/O module installation and wiring, specifications, error codes and troubleshooting guide. The CLICK PLUS PLC Hardware User Manual can be downloaded free at the AutomationDirect Web site; [www.AutomationDirect.com](http://www.AutomationDirect.com)



## **C0-USER-M**     **\$0.00** **CLICK PLC Hardware User Manual**

Manual covers all CLICK PLC and I/O module installation and wiring, specifications, error codes and troubleshooting guide. The CLICK PLC Hardware User Manual can be downloaded free at the AutomationDirect Web site; [www.AutomationDirect.com](http://www.AutomationDirect.com)



## **C0-PGMSW**     **\$12.00** **Programming Software USB**

The programming software can be downloaded free at the AutomationDirect Web site, or the USB can be purchased from the AutomationDirect online Web store. [www.AutomationDirect.com](http://www.AutomationDirect.com)



## **EA-MG-PGM-CBL**     **\$52.00** **PC to Panel Programming Cable Assembly for C-more Micro-Graphic Panels and CLICK/CLICK PLUS PLCs**

The 6-ft cable assembly connects a personal computer to any **C-more** Micro-Graphic panel, CLICK PLC, or select CLICK PLUS PLC for setup and programming.

*Note: This cable assembly uses the PC's USB port and converts the signals to serial transmissions. The USB port supplies 5VDC to the Micro-Graphic panel for configuration operations.*

Assembly includes standard USB A-type connector to B-type connector cable, custom converter, and an RS232C cable with an RJ12 modular connector on each end.



## **USB-CBL-AMICB6**     **\$5.25** **USB A to USB microB Programming Cable Assembly (CLICK PLUS Only)**

Programming cable, USB A to USB microB, 6ft (1.83 m) length. For use with CLICK PLUS PLCs and most USB devices. The USB port supplies 5VDC to the CLICK PLUS CPU for programming.



## **D2-DSCBL**     **\$35.00** **Programming Cable for CLICK/CLICK PLUS and DirectLOGIC PLCs**

12ft. (3.66 m) RS232 shielded PC programming cable for CLICK, select CLICK PLUS PLCs, DL05, DL06, DL105, DL205, D3-350, D4-450, D4-454, and Do-more H2 and T1H series CPUs. 9-pin D-shell female connector to an RJ12 6P6C connector.



*Note: If your PC has a USB port but does not have a serial port, you must use programming cable EA-MG-PGM-CBL to connect to CLICK PLCs. For CLICK PLUS PLCs, you may also use USB-CBL-AMICB6*

## **C0-3TB**     **\$10.00** **Spare 3-Pole Terminal Block**

Replacement 3-pole terminal block for the 3-wire RS-485 Port 3 on CLICK Standard and Analog PLCs as well as the CLICK PLUS C2-03CPU. Sold in packs of 2.



## **C0-4TB**     **\$10.00** **Spare 24VDC Power Terminal Block**

Replacement terminal block for the 24VDC supply power to the PLC. Sold in packs of 2.

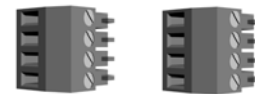

## **C0-8TB**     **\$16.50** **Spare 8-Point I/O Terminal Block**

Replacement terminal block for the 8-point I/O modules. Sold in packs of 2.

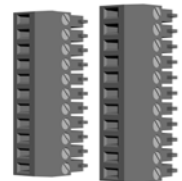

## **C0-8TB-1**     **\$19.50** **Spare 13-Point I/O Terminal Block**

Replacement terminal block for the 8-point I/O relay modules. Sold in packs of 2.



## **C0-16TB**     **\$23.00** **Spare 16-Point I/O Terminal Block**

Replacement terminal block for the 16-point I/O modules and PLC built-in I/O. Sold in packs of 2.

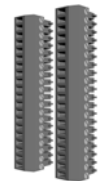

## **C2-6TB**     **\$16.50** **Spare 6-pt Terminal Block**

Replacement terminal block for the C2-DCM serial ports. Sold in packs of 2.



# Accessories

**SE-ANT250     \$37.00**  
***Wi-Fi/Bluetooth Dome Antenna***

2.4 GHz antenna, IP67, panel mount, 9.8 ft (3m) cable length, for external mounting when CLICK PLUS PLC is installed in a metallic enclosure.



**C2-FILL     \$8.50**  
***CPU Option Slot Cover***

Snap-on cover for CLICK PLUS CPU Option Slot in applications without an Option Slot module present.

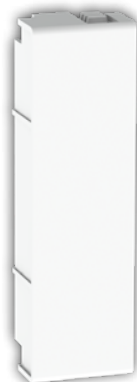

**MSD-SLC16G     \$100.00**  
 16GB microSD card, industrial grade, 3D NAND Flash (with SLC Mode), 85°C [185°F] max operating temp.



**SE-ANT210     \$10.50**  
***Wi-Fi/Bluetooth Whip Antenna***

Whip/straight 2.4 GHz antenna, IP65, connector mount. Not recommended for installation in a metallic enclosure.



**D2-BAT-1     \$6.50**  
 Replacement CR2354 battery for Standard, Analog, Ethernet Standard and Ethernet Analog PLC units.



**TW-SD-MSL-2     \$4.00**  
***Insulated Slotted Screwdriver***  
 0.4 x 2.5 x 80 mm slotted screwdriver for terminal blocks.



**DN-EB35MN     \$31.50**  
***DINector End Bracket***



**D0-MC-BAT     \$3.00**  
 Replacement CR2032 battery for CLICK PLUS PLC units.



**DN-WS     \$72.00**  
***Wire Stripper***



***C-more and C-more Micro Graphic Operator Interfaces***



***ZIPLink Wiring Systems***

