

CLICK Stackable I/O Module Specifications

C0-08TR-3

\$61.00

8-Point Relay Output Module

8-point 6-27 VDC/6-240 VAC relay output module, 8 Form A (SPST) relays, 4 commons, isolated, 3 A/point, removable terminal block included (replacement AutomationDirect p/n C0-8TB-1).

Wiring Diagram

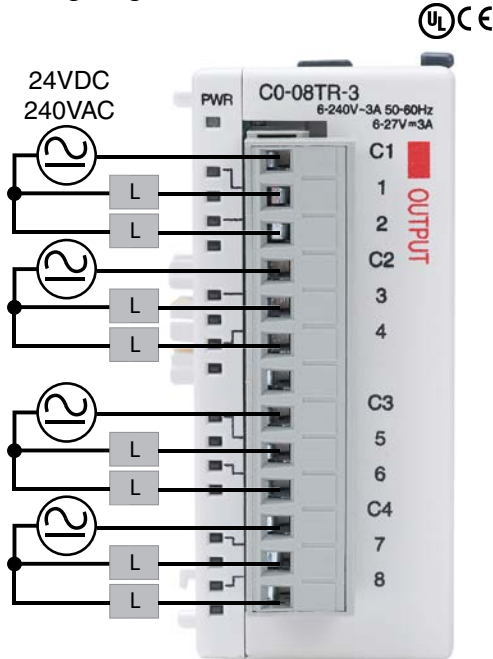

Output Specifications

Outputs per Module	8
Operating Voltage Range	6-27 VDC / 6-240 VAC
Peak Voltage	30 VDC / 264 VAC
Output type	Relay, form A (SPST)
AC Frequency	47-63 Hz
Maximum Current (resistive)	3A/point, 6A/common
Minimum Load Current	5mA @ 5VDC
Maximum Inrush Current	5A for 10ms
OFF to ON Response	< 15ms
ON to OFF Response	< 15ms
Status Indicators	Logic Side (8 points, red LED) Power Indicator (green LED)
Commons	4 (2 points/common)
Bus Power Required (24VDC)	Max. 90mA (All Outputs On)
Protection Circuit	Not built into the module - Install protection elements such as external fuse
Terminal Block Replacement	AutomationDirect p/n C0-8TB-1
Drawing Link	PDF
Weight	4.1 oz [117g]

Typical Relay Life (Operations) at Room Temperature

Voltage & Load Type	Relay Life
24VDC, 3A Resistive	100,000 cycles
24VDC, 3A Inductive	50,000 cycles
110VAC, 3A Resistive	100,000 cycles
110VAC, 3A Inductive	25,000 cycles
220VAC, 3A Resistive	100,000 cycles
220VAC, 3A Inductive	25,000 cycles

ON to OFF = 1 cycle

Output Temperature Derating Chart

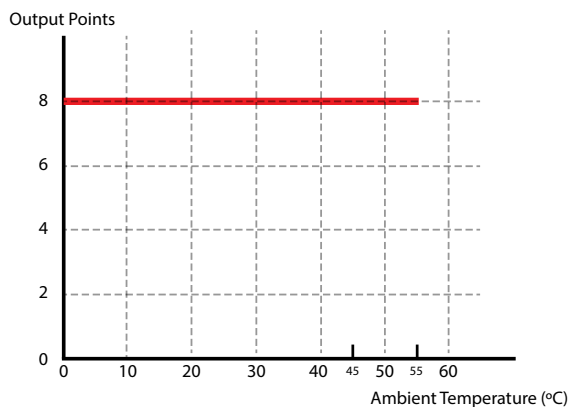

Equivalent Output Circuit

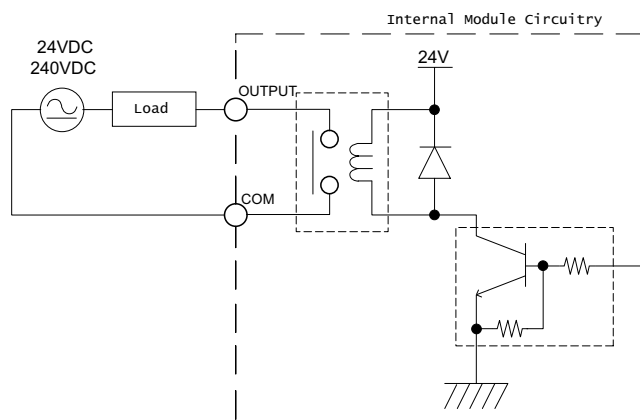

CLICK Stackable I/O Module Specifications

General Specifications For All CLICK Stackable I/O Modules

These general specifications apply to all CLICK Stackable I/O Modules. Please refer to the appropriate I/O temperature derating charts under the PLC (CLICK PLC with built-in I/O), Option Slot module (CLICK PLUS only), and Stackable I/O module specification to determine best operating conditions based on the ambient temperature of your particular application.



NOTE: These modules are available to use with CLICK or CLICK PLUS systems.

General Specifications	
Operating Temperature	Analog, analog combo I/O modules only: 32°F to 140°F [0°C to 60°C]; All other modules: 32°F to 131°F [0°C to 55°C], IEC 60068-2-14 (Test Nb, Thermal Shock)
Storage Temperature	-4°F to 158°F [-20°C to 70°C] IEC 60068-2-1 (Test Ab, Cold) IEC 60068-2-2 (Test Bb, Dry Heat) IEC 60068-2-14 (Test Na, Thermal Shock)
Ambient Humidity	30% to 95% relative humidity (non-condensing)
Environmental Air	No corrosive gases. Environmental pollution level is 2 (UL840)
Vibration	MIL STD 810C, Method 514.2, EC60068-2-27, Category [f], Procedure[VIII] JIS C60068-2-27 (Sine wave vibration test)
Shock	MIL STD 810C, Method 516.2, IEC60068-2-27, JIS C60068-2-27, Category [f], Procedure[VIII]
Noise Immunity	<EN61131-2> EN61000-4-2 (ESD) EN61000-4-3 (RFI) EN61000-4-4 (FTB) EN61000-4-5 (Surge) EN61000-4-6 (Conducted) EN61000-4-8 (Power frequency magnetic field immunity) <Local Test> Impulse noise 1μs, 1000V RFI: No interference measured at 150 and 450 MHz (5w/15cm)
Emissions	EN55011:1998 Class A; EN61000-6-4:2007+A1:2011
Agency Approvals	UL508, UL61010-2-201 (File No. E157382, E316037); CE (EN61131-2); CUL Canadian C22.2
Other	RoHS 2011/65/EU Amendment (EU)2015/863

Power Budgeting

Power Consumption for CLICK Stackable I/O Modules

I/O Module Current Consumption (mA)		
Part Number	Power Budget 24VDC (logic side)	External 24VDC (field side)
Discrete Input Modules		
C0-08SIM	50	0
C0-08ND3	30	0
C0-08ND3-1	30	0
C0-16ND3	40	0
C0-08NE3	30	0
C0-16NE3	40	0
C0-08NA	30	0
Discrete Output Modules		
C0-08TD1	50	15
C0-08TD2	50	0
C0-16TD1	80	100
C0-16TD2	80	0
C0-08TA	80	0
C0-04TRS	100	0
C0-04TRS-10	120	0
C0-08TR	100	0
C0-08TR-3	90	0

I/O Module Current Consumption (continued) (mA)		
Part Number	Power Budget 24VDC (logic side)	External 24VDC (field side)
Discrete Combo I/O Modules		
C0-16CDD1	80	50
C0-16CDD2	80	0
C0-08CDR	80	0
Analog Input Modules		
C0-04AD-1	20	65
C0-04AD-2	23	65
C0-04RTD	25	0
C0-04THM	25	0
Analog Output Modules		
C0-04DA-1	20	145
C0-04DA-2	20	85
Analog Combo I/O Modules		
C0-4AD2DA-1	25	75
C0-4AD2DA-2	20	65
C-more Micro-Graphic Panel		
Monochrome only	90	0

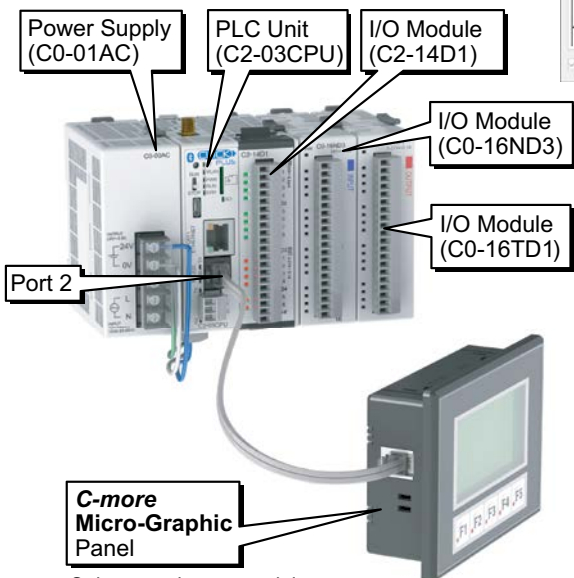
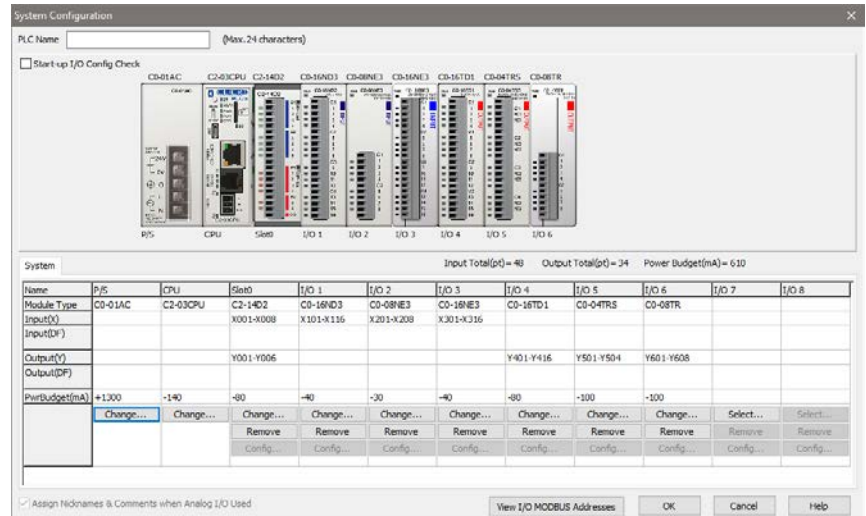

Only monochrome models can be powered from port 2.

Power Budgeting Example

Current Consumption (mA) Example		
Part Number	Power Budget 24VDC (logic side)	External 24VDC (field side)
C2-03CPU	130	0
C2-14D1	50	60
C0-16ND3	40	0
C0-16TD1	80	100
C-more Micro	90	0
Total:	390	160 *

* Add in calculated load of connected I/O devices.

Accessories

C2-USER-M **\$0.00** **CLICK PLUS PLC Hardware User Manual**

Manual covers all CLICK PLUS PLC and I/O module installation and wiring, specifications, error codes and troubleshooting guide. The CLICK PLUS PLC Hardware User Manual can be downloaded free at the AutomationDirect Web site; www.AutomationDirect.com



C0-USER-M **\$0.00** **CLICK PLC Hardware User Manual**

Manual covers all CLICK PLC and I/O module installation and wiring, specifications, error codes and troubleshooting guide. The CLICK PLC Hardware User Manual can be downloaded free at the AutomationDirect Web site; www.AutomationDirect.com



C0-PGMSW **\$12.00** **Programming Software USB**

The programming software can be downloaded free at the AutomationDirect Web site, or the USB can be purchased from the AutomationDirect online Web store. www.AutomationDirect.com



EA-MG-PGM-CBL **\$52.00** **PC to Panel Programming Cable Assembly for C-more Micro-Graphic Panels and CLICK/CLICK PLUS PLCs**

The 6-ft cable assembly connects a personal computer to any **C-more** Micro-Graphic panel, CLICK PLC, or select CLICK PLUS PLC for setup and programming.

Note: This cable assembly uses the PC's USB port and converts the signals to serial transmissions. The USB port supplies 5VDC to the Micro-Graphic panel for configuration operations.

Assembly includes standard USB A-type connector to B-type connector cable, custom converter, and an RS232C cable with an RJ12 modular connector on each end.



USB-CBL-AMICB6 **\$5.25** **USB A to USB microB Programming Cable Assembly (CLICK PLUS Only)**

Programming cable, USB A to USB microB, 6ft (1.83 m) length. For use with CLICK PLUS PLCs and most USB devices. The USB port supplies 5VDC to the CLICK PLUS CPU for programming.



D2-DSCBL **\$35.00** **Programming Cable for CLICK/CLICK PLUS and DirectLOGIC PLCs**

12ft. (3.66 m) RS232 shielded PC programming cable for CLICK, select CLICK PLUS PLCs, DL05, DL06, DL105, DL205, D3-350, D4-450, D4-454, and Do-more H2 and T1H series CPUs. 9-pin D-shell female connector to an RJ12 6P6C connector.



Note: If your PC has a USB port but does not have a serial port, you must use programming cable EA-MG-PGM-CBL to connect to CLICK PLCs. For CLICK PLUS PLCs, you may also use USB-CBL-AMICB6

C0-3TB **\$10.00** **Spare 3-Pole Terminal Block**

Replacement 3-pole terminal block for the 3-wire RS-485 Port 3 on CLICK Standard and Analog PLCs as well as the CLICK PLUS C2-03CPU. Sold in packs of 2.



C0-4TB **\$10.00** **Spare 24VDC Power Terminal Block**

Replacement terminal block for the 24VDC supply power to the PLC. Sold in packs of 2.

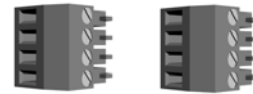

C0-8TB **\$16.50** **Spare 8-Point I/O Terminal Block**

Replacement terminal block for the 8-point I/O modules. Sold in packs of 2.

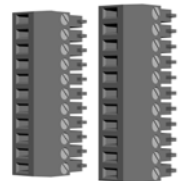

C0-8TB-1 **\$19.50** **Spare 13-Point I/O Terminal Block**

Replacement terminal block for the 8-point I/O relay modules. Sold in packs of 2.



C0-16TB **\$23.00** **Spare 16-Point I/O Terminal Block**

Replacement terminal block for the 16-point I/O modules and PLC built-in I/O. Sold in packs of 2.

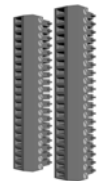

C2-6TB **\$16.50** **Spare 6-pt Terminal Block**

Replacement terminal block for the C2-DCM serial ports. Sold in packs of 2.

