

# BX-xxNA 120–240 VAC Input Modules

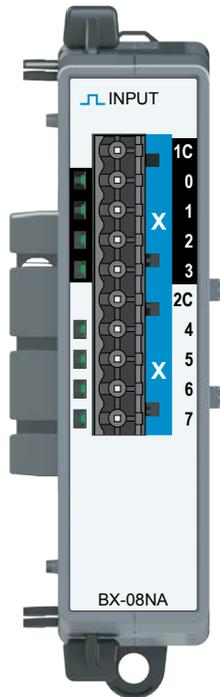

**BX-08NA \$53.00**

Input Module  
8-pt, 120–240 VAC

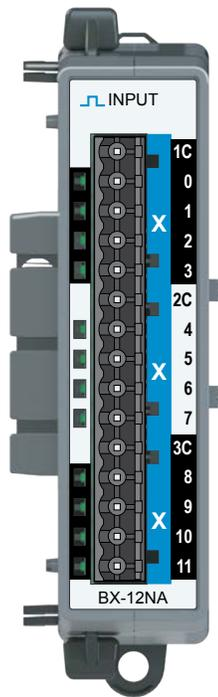

**BX-12NA \$69.00**

Input Module  
12-pt, 120–240 VAC

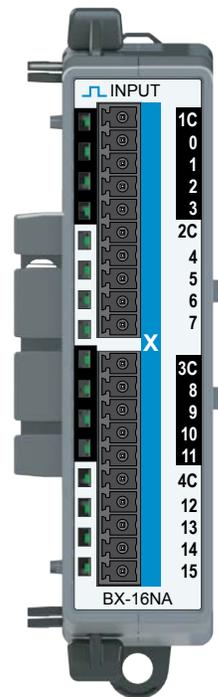

**BX-16NA \$77.00**

Input Module  
16-pt, 120–240 VAC

**Terminal Blocks  
Sold Separately**

We recommend using prewired ZIPLink cables and connection modules. If you wish to hand-wire your module, a removable terminal block is available. See Wiring Solutions section for all options.



Discrete Input Specifications		
<b>Input Type</b>		AC
<b>Inputs per Module</b>	<b>BX-08NA</b>	8
	<b>BX-12NA</b>	12
	<b>BX-16NA</b>	16
<b>Commons</b>	<b>BX-08NA</b>	2 (4pts / common) Isolated
	<b>BX-12NA</b>	3 (4pts / common) Isolated
	<b>BX-16NA</b>	4 (4pts / common) Isolated
<b>Nominal Voltage Rating</b>		120–240 VAC
<b>Input Voltage Range</b>		85–264 VAC
<b>Maximum Voltage</b>		264VAC RMS
<b>AC Frequency</b>		47–63 Hz
<b>Input Impedance</b>		15kΩ
<b>Input Current (typical)</b>		9mA @ 120VAC, 13mA @ 220VAC
<b>Maximum Input Current</b>		14mA @ 120VAC, 20mA @ 220VAC
<b>ON Voltage Level</b>		> 85VAC
<b>OFF Voltage Level</b>		< 40VAC
<b>Maximum OFF Current</b>		2.5 mA
<b>OFF-ON Response</b>		10ms
<b>ON-OFF Response</b>		10ms
<b>Status Indicators</b>		Logic Side, Green

**IMPORTANT!**



**Hot-Swapping Information**

Note: This device cannot be Hot Swapped.

**Discrete Input Wiring**

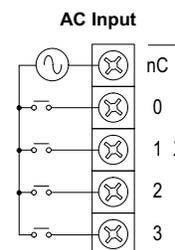

# BRX Discrete Expansion Modules

## Overview

One of the unique features of the BRX platform is its ability to expand its capability to fit your application solution. One of the ways the BRX platform can do this is by using expansion modules that conveniently “snap-on” to the side of any BRX MPU. Once the expansion module has been snapped in place and is added to the project, it instantly adds I/O to the MPU with little to no additional setup required.

The expansion modules give you the ability to add discrete I/O as needed and are identified as an input module, output module or combination input/output module. On the front panel of the discrete I/O

expansion modules, a color scheme and a symbol are used to denote the module type.

Most modules are available in 5, 8, 12 or 16 point variations consisting of sink/source DC inputs/outputs, AC inputs/outputs, relay outputs and combination modules. Some are available with 32 points.

The modules ship without wiring terminals. This allows you to select the termination style that best fits your application. Several wiring options are available, including screw terminal connectors, spring clamp terminal connectors and pre-wired **ZIPLink** cable solutions.

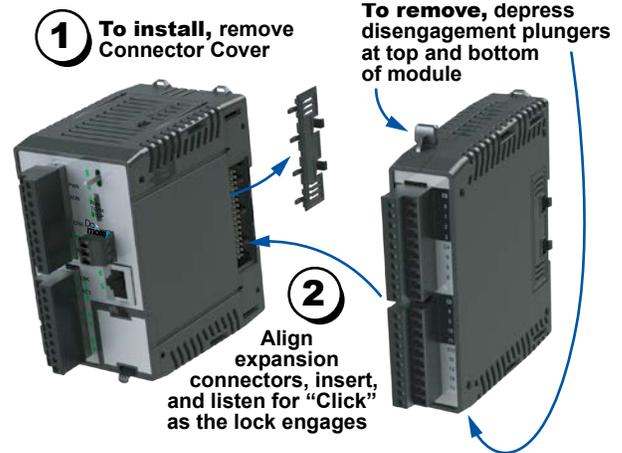

**Hot-Swapping Information**  
 Note: This device cannot be Hot Swapped.

## General Specifications

All BRX discrete expansion modules have the same general specifications listed in the table below.

General Specifications	
<b>Operating Temperature</b>	0° to 60°C (32° to 140°F)
<b>Storage Temperature</b>	-20° to 85°C (-4° to 185°F)
<b>Humidity</b>	5 to 95% (non-condensing)
<b>Environmental Air</b>	No corrosive gases permitted
<b>Vibration</b>	IEC60068-2-6 (Test Fc)
<b>Shock</b>	IEC60068-2-27 (Test Ea)
<b>Enclosure Type</b>	Open Equipment
<b>Noise Immunity</b>	NEMA ICS3-304
<b>EU Directive</b>	See the "EU Directive" topic in the Help File
<b>Agency Approvals</b>	UL 61010-2 - UL File # E185989 Canada and USA CE Compliant EN61131-2

## Dimensions, inches[mm]

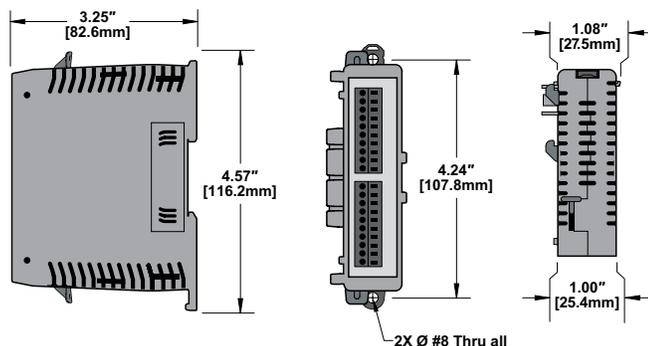

**NOTE:** When removing an expansion module make sure there is room for the module to slide away from the system. Failure to do so will result in difficulty in removing the module.

# BRX Discrete Expansion Modules

## Discrete Input Modules

Thirteen (13) discrete input modules are available in various DC and AC voltage ranges. Input module faceplates have a blue terminal bar and symbol  for easy distinction from other module types.

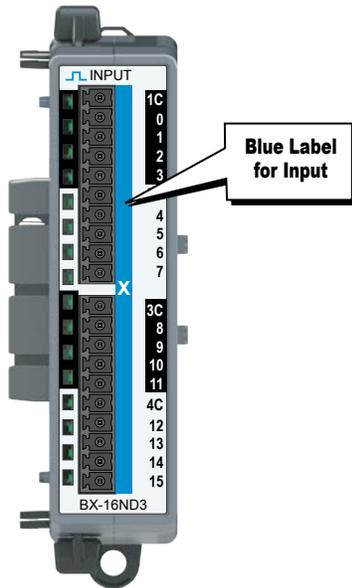

Discrete Input Modules			
Part Number	Points	Input Type	Price
<a href="#">BX-08NF3</a>	8	3 – 5 VDC Sink / Source	\$47.50
<a href="#">BX-08ND3</a>		12 – 24 VDC Sink / Source	\$54.00
<a href="#">BX-08NB</a>		24VAC	\$49.00
<a href="#">BX-08NA</a>		120VAC	\$53.00
<a href="#">BX-08SIM</a>		Simulator	\$64.00
<a href="#">BX-12ND3</a>	12	12 – 24 VDC Sink / Source	\$65.00
<a href="#">BX-12NB</a>		24VAC	\$51.00
<a href="#">BX-12NA</a>		120VAC	\$69.00
<a href="#">BX-16NF3</a>	16	3–5 VDC Sink/Source	\$69.00
<a href="#">BX-16ND3</a>		12 – 24 VDC Sink / Source	\$71.00
<a href="#">BX-16NB</a>		24VAC	\$61.00
<a href="#">BX-16NA</a>		120VAC	\$77.00
<a href="#">BX-32ND3</a>	32	12 – 24 VDC Sink / Source	\$139.00

## Discrete Output Modules

Eighteen (18) discrete output modules are available in DC sinking, DC sourcing, AC voltage and Relay type outputs. Output module faceplates have a red terminal bar and symbol  for easy distinction from other module types.

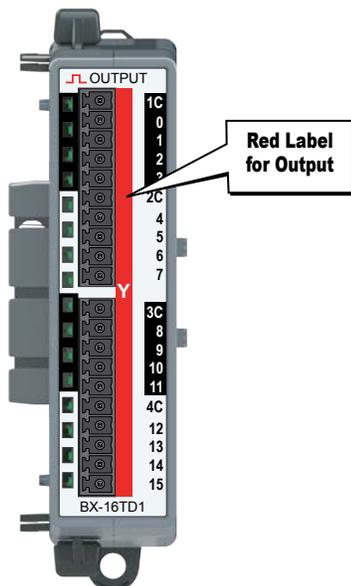

Discrete Output Modules			
Part Number	Points	Output Type	Price
<a href="#">BX-05TRS</a>	5	Relay Form C (SPDT)	\$69.00
<a href="#">BX-05TRS-1</a>		Relay Form C (SPDT)	\$85.00
<a href="#">BX-08TD1</a>	8	12 – 24 VDC Sinking	\$63.00
<a href="#">BX-08TD2</a>		12 – 24 VDC Sourcing	\$63.00
<a href="#">BX-08TR</a>		Relay Form A (SPST)	\$69.00
<a href="#">BX-08TA</a>		120 – 240 VAC Triac	\$111.00
<a href="#">BX-08TRZ</a>		Relay Form A (SPST), no surge suppression	\$78.00
<a href="#">BX-12TD1</a>	12	12 – 24 VDC Sinking	\$93.00
<a href="#">BX-12TD2</a>		12 – 24 VDC Sourcing	\$85.00
<a href="#">BX-12TR</a>		Relay Form A (SPST)	\$93.00
<a href="#">BX-12TA</a>		120 – 240 VAC Triac	\$129.00
<a href="#">BX-16TD1</a>	16	12 – 24 VDC Sinking	\$99.00
<a href="#">BX-16TD2</a>		12 – 24 VDC Sourcing	\$99.00
<a href="#">BX-16TF2</a>		3–5 VDC Sourcing	\$93.00
<a href="#">BX-16TR</a>		Relay Form A (SPST)	\$105.00
<a href="#">BX-16TRZ</a>	16	Relay Form A (SPST), no surge suppression	\$112.00
<a href="#">BX-32TD1</a>		32	12 – 24 VDC Sinking
<a href="#">BX-32TD2</a>	12 – 24 VDC Sourcing		\$140.00

# BRX Discrete Expansion Modules

## Discrete Combo Input / Output Modules

Six discrete input/output combo modules are available with DC sink/source inputs and sink/source/relay outputs. The Input/Output faceplate terminal bar is in blue and red, making it easy to distinguish between inputs and outputs and from other module types.

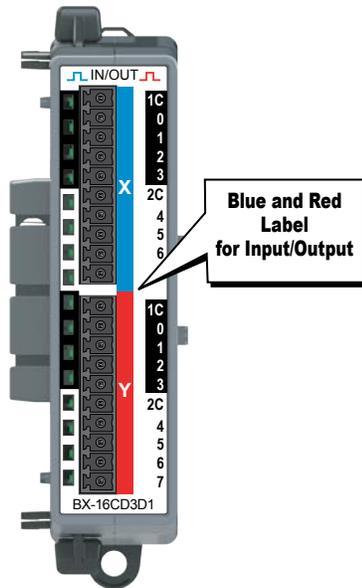

Discrete Combo Input / Output Modules					
Part Number	Points		Input Type	Output Type	Price
	Input	Output			
<a href="#"><u>BX-08CD3R</u></a>	4	4	12-24 VDC Sink / Source	Relay Form A (SPST)	\$69.00
<a href="#"><u>BX-12CD3D1</u></a>	8	4		12-24 VDC Sinking	\$69.00
<a href="#"><u>BX-12CD3D2</u></a>				12-24 VDC Sourcing	\$69.00
<a href="#"><u>BX-16CD3D1</u></a>	8	8		12-24 VDC Sinking	\$85.00
<a href="#"><u>BX-16CD3D2</u></a>				12-24 VDC Sourcing	\$92.00
<a href="#"><u>BX-16CF3F2</u></a>				3-5 VDC Sink/Source	3-5 VDC Sourcing

Expansion Module Support by Controller	
Controller Type	# Expansion Modules
<a href="#"><u>BX-DM1E-M</u></a>	8
<a href="#"><u>BX-DM1-10</u></a>	2
<a href="#"><u>BX-DM1E-10</u></a>	2
<a href="#"><u>BX-DM1-18</u></a>	4
<a href="#"><u>BX-DM1E-18</u></a>	8
<a href="#"><u>BX-DM1-36</u></a>	4
<a href="#"><u>BX-DM1E-36</u></a>	8
<a href="#"><u>BX-DMIO*</u></a>	8
<a href="#"><u>BX-EBC100*</u></a>	8
<a href="#"><u>BX-MBIO*</u></a>	8

\* Remote I/O controllers do not support Motion Control and Communications Modules.

# BRX Wiring Termination Options

## Terminal Block Connectors

The terminal block connectors are provided in kits of multiple connectors that are ordered as a single part number. There are 2 different types of kits to choose from; one kit for the five (5), eight (8) and 12-point discrete, and one

kit for the analog modules and 16-point discrete modules. The five (5), eight (8) and 12-point discrete module kits each have (3) 5-pin 5mm connectors. The 8-point modules will use only 2 of the 5-pin connectors.

The five (5) and 12-point modules will use all three connectors. The analog and 16-point digital module kits include (2) 10-pin 3.81 mm connectors.

## Terminal Block Connectors, 5, 8 and 12-Point Discrete Modules

Terminal Block Kits for 5-point, 8-point and 12-point Expansion Modules



**BX-RTB08 (Kit - 3 pieces)**



**BX-RTB08-1 (Kit - 3 pieces)**



**BX-RTB08-2 (Kit - 3 pieces)**

Terminal Block Specifications 5-, 8- & 12-Point Type			
Part Number Single Block Set of 3 Blocks	<b><i>BX-RTB05</i></b> <b><i>BX-RTB08</i></b>	<b><i>BX-RTB05-1</i></b> <b><i>BX-RTB08-1</i></b>	<b><i>BX-RTB05-2</i></b> <b><i>BX-RTB08-2</i></b>
Price (Single Block)	\$8.50	\$7.00	\$8.00
Price (Kit)	\$15.00	\$14.50	\$15.00
Connector Type	Screw Type - 90-degree	Spring Clamp Type - 180-degree	Screw Type - 180-degree
Wire Exit	180-degree	180-degree	180-degree
Pitch	5.0 mm	5.0 mm	5.0 mm
Screw Size	M2.5	N/A	M2.5
Screw Torque Recommended	< 3.98 lb-in (0.45 N·m)	N/A	< 3.98 lb-in (0.45 N·m)
Screwdriver Blade Width	3.5 mm	3.5 mm	3.5 mm
Wire Gauge (Single Wire)	28-12 AWG	28-14 AWG	28-12 AWG
Wire Gauge (Dual Wire)	28-16 AWG	28-16 AWG (Dual Wire Ferrule Required)	28-16 AWG
Wire Strip Length	0.3 in (7.5 mm)	0.37 in (9.5 mm)	0.3 in (7.5 mm)
Equiv. Dinkle P/N	5ESDV-05P-BK	5ESDSR-05P-BK	5ESDF-05P-BK

## Terminal Block Connectors, Analog Modules and 16-Point Discrete Modules

Terminal Block Kits for Analog and 16-point Discrete Expansion Modules



**BX-RTB10 (Kit - 2 pieces)**



**BX-RTB10-1 (Kit - 2 pieces)**



**BX-RTB10-2 (Kit - 2 pieces)**

Terminal Block Specifications 16-Point Type			
Part Number	<b><i>BX-RTB10</i></b>	<b><i>BX-RTB10-1</i></b>	<b><i>BX-RTB10-2</i></b>
Price (Kit)	\$21.50	\$24.00	\$22.50
Connector Type	Screw Type 90-degree	Spring Clamp Type 180-degree	Screw Type 180-degree
Wire Exit	180-degree	180-degree	180-degree
Pitch	3.81 mm	3.81 mm	3.81 mm
Screw Size	M2	N/A	M2
Screw Torque Recommended	<1.77 lb-in (0.2 N·m)	N/A	<1.77 lb-in (0.2 N·m)
Screwdriver Blade Width	2.5 mm	2.5 mm	2.5 mm
Wire Gauge (Single Wire)	28-16 AWG	26-18 AWG	30-16 AWG
Wire Gauge (Dual Wire)	28-18 AWG	30-20 AWG (Dual Wire Ferrule Required)	30-18 AWG
Wire Strip Length	0.24 in (6mm)	0.35 in (9mm)	0.26 in (6.5 mm)
Equiv. Dinkle P/N	EC381V-10P-BK	ESC381V-10-BK	EC381F-10P-BK



**NOTE:** BX-RTB10 terminal blocks are included with Temperature Input modules.

# BRX Wiring Termination Options

## ZIPLink Wiring System

BRX expansion modules can be quickly connected to convenient **ZIPLink** remote terminal blocks for ease of wiring I/O devices. Your **ZIPLink** selection is dependent on the number of expansion module terminal points. The following tables list the connector options.



### 8-Point BRX Discrete Expansion Module ZIPLink Selector

Expansion Module Part No.	ZIPLink Module	ZIPLink Module Part No.	Qty Needed	ZIPLink Cable Part No.*	Qty Needed
<a href="#">BX-08ND3</a>	Feedthrough	ZL-RTB20 (Standard) OR ZL-RTB20-1 (Compact)	1	ZL-BXEM-CBL10 <a href="#">ZL-BXEM-CBL10-1</a> <a href="#">ZL-BXEM-CBL10-2</a>	1
<a href="#">BX-08NF3</a>					
<a href="#">BX-08NA</a>					
<a href="#">BX-08NB</a>					
<a href="#">BX-08TD1</a>					
<a href="#">BX-08TD2</a>					
<a href="#">BX-08TR**</a>					
<a href="#">BX-08TRZ**</a>					
<a href="#">BX-08TA</a>					
<a href="#">BX-08CD3R**</a>					

\* Select cable length: Blank = 0.5 m, -1 = 1.0m, -2 = 2.0m.

Available pigtail cables: [ZL-BXEM-CBL10-1P](#) = 1.0 m, [ZL-BXEM-CBL10-2P](#) = 2.0 m.

\*\* The relay outputs are derated not to exceed 2A per common when used with the **ZIPLink** wiring system.

### 12 & 5-Point BRX Discrete Expansion Module ZIPLink Selector

Expansion Module Part No.	ZIPLink Module	ZIPLink Module Part No.	Qty Needed	ZIPLink Cable Part No.*	Qty Needed
<a href="#">BX-12ND3</a>	Feedthrough	ZL-RTB20 (Standard) OR ZL-RTB20-1 (Compact)	1	ZL-BXEM-CBL15 <a href="#">ZL-BXEM-CBL15-1</a> <a href="#">ZL-BXEM-CBL15-2</a>	1
<a href="#">BX-12NA</a>					
<a href="#">BX-12NB</a>					
<a href="#">BX-12TD1</a>					
<a href="#">BX-12TD2</a>					
<a href="#">BX-12TR**</a>					
<a href="#">BX-05TRS</a>					
<a href="#">BX-12TA</a>					
<a href="#">BX-12CD3D1</a>					
<a href="#">BX-12CD3D2</a>					

\* Select cable length: Blank = 0.5 m, -1 = 1.0m, -2 = 2.0m.

Available pigtail cables: [ZL-BXEM-CBL15-1P](#) = 1.0 m, [ZL-BXEM-CBL15-2P](#) = 2.0 m.

\*\* The relay outputs are derated not to exceed 2A per common when used with the **ZIPLink** wiring system.

# BRX Wiring Termination Options

16-Point BRX Discrete Expansion Module ZIPLink Selector							
Expansion Module Part No.	ZIPLink Module	ZIPLink Module Part No.	Qty Needed	ZIPLink Cable Part No. *	Qty Needed		
<b><u>BX-16ND3</u></b>	Sensor	<u>ZL-LTB16-24-1</u>	1	<u>ZL-BXEM-CBL20</u> <u>ZL-BXEM-CBL20-1</u> <u>ZL-BXEM-CBL20-2</u>	1		
	Feedthrough	<u>ZL-RTB20</u> (Standard) OR <u>ZL-RTB20-1</u> (Compact)	1				
<b><u>BX-16NF3</u></b>	Feedthrough						
<b><u>BX-16NA</u></b>							
<b><u>BX-16NB</u></b>	Feedthrough						
<b><u>BX-16TD1</u></b>							
<b><u>BX-16TD2</u></b>	Relay (Sourcing)					<u>ZL-RRL16-24-1</u> , <u>ZL-RRL16W-24-1</u> , <u>ZL-RRL16F-24-1</u> , <u>ZL-RRL16HDF-24-1</u>	1
	Relay (Sinking)					<u>ZL-RRL16-24-2</u> , <u>ZL-RRL16W-24-2</u> , <u>ZL-RRL16F-24-2</u> , <u>ZL-RRL16HDF-24-2</u>	1
<b><u>BX-16TF2</u></b>	Feedthrough					<u>ZL-RTB20</u> (Standard) OR <u>ZL-RTB20-1</u> (Compact)	1
<b><u>BX-16TR**</u></b>							
<b><u>BX-16TRZ**</u></b>							
<b><u>BX-16CD3D1</u></b>							
<b><u>BX-16CD3D2</u></b>							
<b><u>BX-16CF3F2</u></b>							

\* Select cable length: Blank = 0.5 m, -1 = 1.0m, -2 = 2.0m.

Available pigtail cables: ZL-BXEM-CBL20-1P = 1.0 m, ZL-BXEM-CBL20-2P = 2.0 m.

\*\* The relay outputs are derated not to exceed 2A per common when used with the ZIPLink wiring system.

32-Point BRX Discrete Expansion Module ZIPLink Selector					
Expansion Module Part No.	ZIPLink Module	ZIPLink Module Part No.	Qty Needed	ZIPLink Cable Part No. *	Qty Needed
<b><u>BX-32ND3</u></b>	Sensor	<u>ZL-LTB32-24-1</u>	1	<u>ZL-D24-CBL40</u> <u>ZL-D24-CBL40-1</u> <u>ZL-D24-CBL40-2</u>	1
	Feedthrough	<u>ZL-RTB40</u> (Standard) OR <u>ZL-RTB40-1</u> (Compact)	1		
<b><u>BX-32TD1</u></b>	Feedthrough				
<b><u>BX-32TD2</u></b>					

\* Select cable length: Blank = 0.5 m, -1 = 1.0m, -2 = 2.0m.

Available pigtail cables: ZL-D24-CBL40-1P = 1.0 m, ZL-D24-CBL40-2P = 2.0 m.

Suffix -X indicates 45° cable connector angle. Non -X indicates 180° cable connector angle.

16-Point BRX High Speed Expansion Module ZIPLink Selector					
Expansion Module Part No.	ZIPLink Module	ZIPLink Module Part No.	Qty Needed	ZIPLink Cable Part No. *	Qty Needed
<b><u>BX-HSIO4</u></b>	Feedthrough	<u>ZL-RTB40</u> (Standard) OR <u>ZL-RTB40-1</u> (Compact)	1	<u>ZL-BX-CBL40-S</u> <u>ZL-BX-CBL40-1S</u>	1

# BRX Wiring Termination Options

BRX Analog and Temperature Expansion Module ZIPLink Selector					
Expansion Module Part No.	ZIPLink Module	ZIPLink Module Part No.	Qty Needed	ZIPLink Cable Part No. <sup>1</sup>	Qty Needed
<a href="#">BX-04ADM-1</a>	Feedthrough	ZL-RTB20 (Standard) OR ZL-RTB20-1 (Compact)	1	ZL-BXEM-CBL20 ZL-BXEM-CBL20-1 ZL-BXEM-CBL20-2	1
<a href="#">BX-04AD-1</a>					
<a href="#">BX-08AD-1</a>					
<a href="#">BX-16AD-1</a>					
<a href="#">BX-04AD-2B</a>					
<a href="#">BX-08AD-2B</a>					
<a href="#">BX-16AD-2B</a>					
<a href="#">BX-04DA-1</a>					
<a href="#">BX-08DA-1</a>					
<a href="#">BX-04DA-2B</a>					
<a href="#">BX-08DA-2B</a>					
<a href="#">BX-2AD2DA-1</a>					
<a href="#">BX-4AD2DA-1</a>					
<a href="#">BX-2AD2DA-2B</a>					
<a href="#">BX-4AD2DA-2B</a>					
<a href="#">BX-08AD-3</a>				ZL-BXEM-CBL10 ZL-BXEM-CBL10-1 ZL-BXEM-CBL10-2	1
<a href="#">BX-08DA-3</a>				Temperature Input modules are not supported by the ZIPLink wiring system.	
<a href="#">BX-2AD2DA-3</a>					
<a href="#">BX-4AD4DA-3</a>					
<a href="#">BX-04THM</a>					
<a href="#">BX-08THM</a>					
<a href="#">BX-06RTD</a>					
<a href="#">BX-08NTC</a>					
<a href="#">BX-04UT</a>					
<a href="#">BX-08UT</a>					
<a href="#">BX-4THM4DA-1</a>					
<a href="#">BX-4RTD4DA-1</a>					
<a href="#">BX-4UT4DA-3</a>					
<a href="#">BX-4UT4TD1</a>					
<a href="#">BX-4UT4TD2</a>					
<a href="#">BX-4UT4TR</a>					

1. Select cable length: Blank = 0.5 m, -1 = 1.0m, -2 = 2.0m.  
Available pigtail cables: ZL-BXEM-CBL20-1P = 1.0 m, ZL-BXEM-CBL20-2P = 2.0 m.