

# BX-xxAD-1 Analog Current Sinking Input

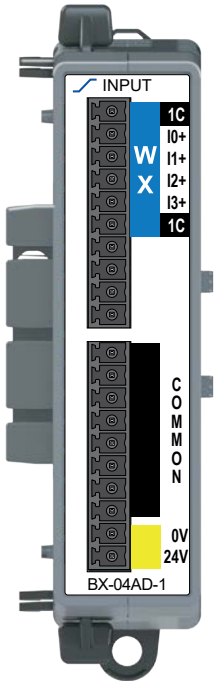

**BX-04AD-1**  
\$230.00

Input Module 4-pt,  
Analog Current Sinking

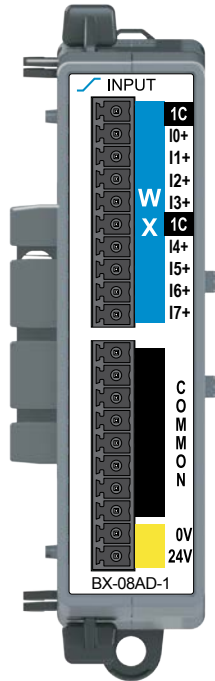

**BX-08AD-1**  
\$255.00

Input Module 8-pt,  
Analog Current Sinking

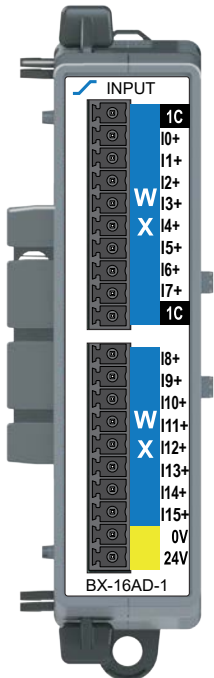

**BX-16AD-1**  
\$363.00

Input Module 16-pt,  
Analog Current Sinking

Terminal Blocks Sold Separately

Analog Current Sinking Input Specifications			
Specification	BX-04AD-1	BX-08AD-1	BX-16AD-1
Inputs per Module	4	8	16
Commons	1		
Module Signal Input Range	0–20mA, 4–20mA (Default)		
Signal Resolution	16-bit, 15-bit (Default)		
Resolution Value of LSB	See Data Range Specifications table		
Input Impedance	125Ω±0.1%, 1/10th watt	256Ω±0.1%, 1/10th watt	
All Channel Update Rate	45ms	80ms	
Over Current Circuit Detection Time	< 1second	NA	
Maximum Continuous Overload	±28mA		
Sample Duration Time	5μs per channel	100μs per channel	
Hardware Filter Characteristics	Low Pass 1st order, -3dB @ 144Hz	Low Pass 2nd order, -3dB @ 15kHz	
Conversion Method	Successive approximation		
Linearity Error (end to end)	±0.09% of range		
Input Stability and Repeatability (after 10 min. warmup)	±0.035% of range	±0.05% of range	
Full Scale Calibration Error	±0.1% of range		
Offset Calibration Error	±0.1% of range		
Accuracy vs. Temperature	±25PPM / °C maximum		
Maximum Inaccuracy	0.1% of range (incl. Temperature Drift)		
Maximum Crosstalk	-96dB, 1 LSB	-90dB, 1 LSB	
Channel to Backplane Isolation	1800VAC applied for one second		
Channel to Channel Isolation	None		
Loop Fusing (External)	Fast-acting 0.032A recommended		
Backplane Power Consumption	0.1 W	0.3 W	
External DC Power Required	Class 2 or LPS power supply 24VDC (±20%)		
	25mA	75mA	
Heat Dissipation	0.8 W	2.5 W	2W
Weight	98g (3.5 oz)		110g (3.9 oz)
Software Version Required (Do-more! Designer Programming Software)	2.3 or later	2.1 or later	2.6 or later

We recommend using prewired ZIPLink cables and connection modules. If you wish to hand-wire your module, a removable terminal block is available. See Wiring Solutions section for all options.



## IMPORTANT!



### Hot-Swapping Information

Note: This device cannot be Hot Swapped.

# BX-xxAD-1 Analog Current Sinking Input

Data Range Specifications							
Selection	Description	Enable 16 bit Unchecked (15 bit Resolution, Default)			Enable 16 bit Checked (16 bit Resolution)		
		Raw Counts	Casting*	µA Per Count	Raw Counts	Casting*	µA Per Count
0-20 mA	Unipolar 0-20 mA	0-32767	-	0.61	0-65535	WXn:U	0.31
4-20 mA	Unipolar 4-20 mA	0-32767	-	0.49	0-65535	WXn:U	0.24

\* For more information on Casting, refer to Help topic DMD0309 in the Do-more! Designer Software.

## Analog Current Sinking Input Circuits

\*An Edison S500-32-R 0.032A fast-acting fuse is recommended for all analog voltage inputs, analog outputs, and current loops.

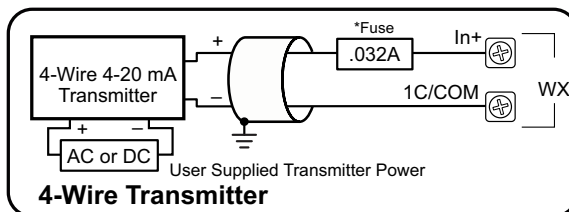
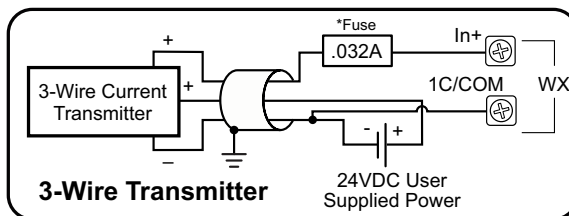
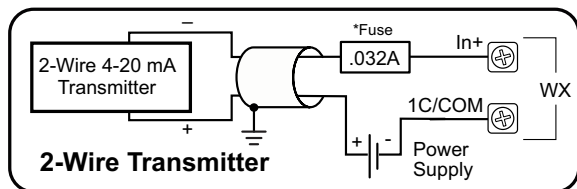

NOTE: Shield should be connected only at one end, to ground at the source device.

## Analog Current Sinking Input Wiring

### BX-04AD-1 / BX-08AD-1

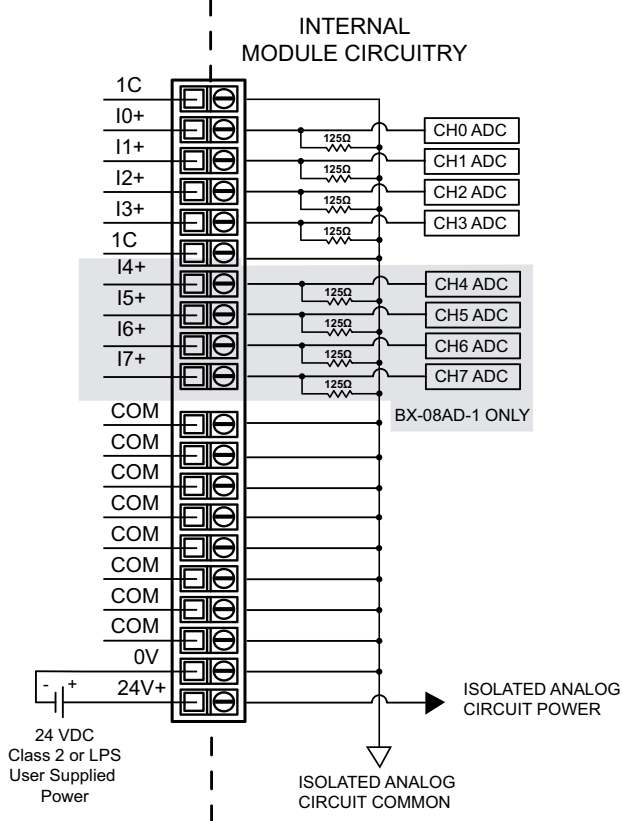

### BX-16AD-1

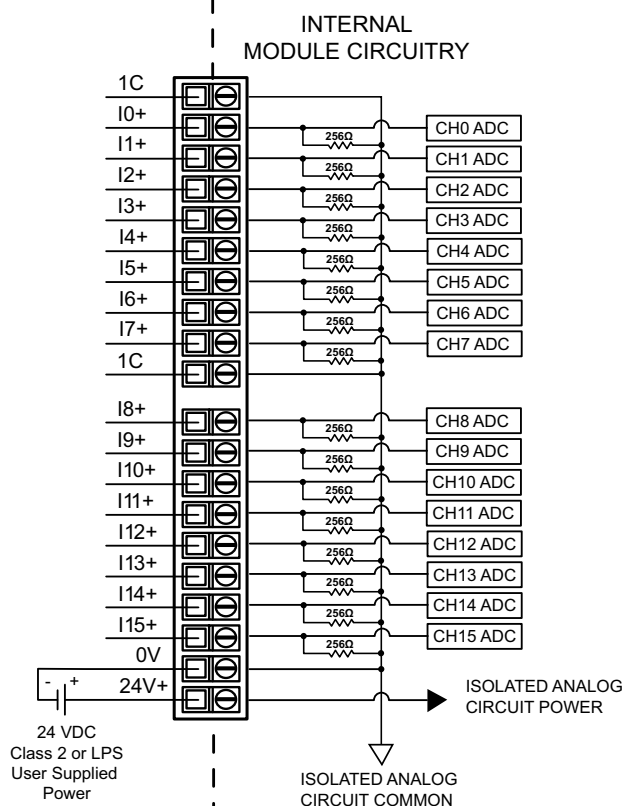

# BRX Analog Expansion Modules

## Overview

One of the unique features of the BRX platform is its ability to expand its capability to fit your application solution. One of the ways the BRX platform can do this is by using expansion modules that conveniently “snap-on” to the side of any BRX MPU. Once the expansion module has been snapped in place and is added to the project, it instantly adds I/O to the MPU with little to no additional setup required.

The analog expansion modules give you the ability to add analog I/O as needed and are identified as an analog input module, temperature input module, or analog output module. On the front panel of the analog I/O expansion modules, a color scheme and a

symbol are used to denote the module type.

Analog modules are available with current inputs or outputs, unipolar/bipolar voltage inputs or outputs, thermocouple inputs, RTD inputs and thermistor inputs. Input/output combination modules are also available.

With the exception of temperature input modules, the modules ship without wiring terminals. This allows you to select the termination style that best fits your application. Several wiring options are available, including screw terminal connectors, spring clamp terminal connectors and pre-wired **ZIP**Link cable solutions.

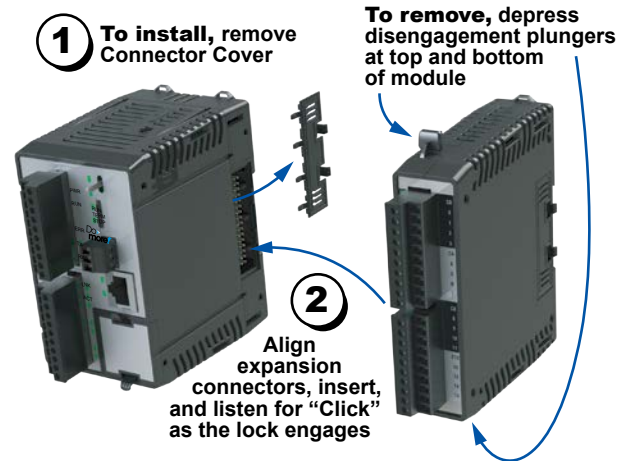

**Hot-Swapping Information**  
 Note: This device cannot be Hot Swapped.

## General Specifications

All BRX analog input and output modules and temperature input modules have the same general specifications listed in the table below.

General Specifications	
<b>Storage Temperature</b>	-20° to 70°C (-4° to 158°F)
<b>Humidity</b>	5% to 95% (non-condensing)
<b>Environmental Air</b>	No corrosive gases permitted
<b>Vibration</b>	IEC60068-2-6 (Test Fc)
<b>Shock</b>	IEC60068-2-27 (Test Ea)
<b>Enclosure Type</b>	Open Equipment
<b>Noise Immunity</b>	NEMA ICS3-304
<b>EU Directive</b>	See the “EU Directive” topic in the BRX Help File
<b>Agency Approvals (unless otherwise noted on individual module specifications)</b>	UL 61010-1 and UL 61010-2-201 File E139594, Canada and USA CE (EN 61131-2 EMC, EN 61010-1 and EN 61010-2-201 Safety)

Operating Temperature Range		
Operating Temperature	0° to 45°C (32° to 113°F)	0° to 60°C (32° to 140°F)
Module	Module Revision*	
<b>BX-08AD-1</b>	Rev A (Prior to May 2018)	Rev B (After May 2018)
<b>BX-08AD-2B</b>		
<b>BX-04THM</b>		
<b>BX-08DA-1</b>	Rev B (Prior to May 2018)	Rev C (After May 2018)
<b>BX-08DA-2B</b>		
<b>All other Analog and Temperature Expansion Module part numbers</b>	N/A	Rev A (After May 2018)

\* Module Revision can be found in the last letter (last or second-to-last character) of the module serial number.

## Dimensions

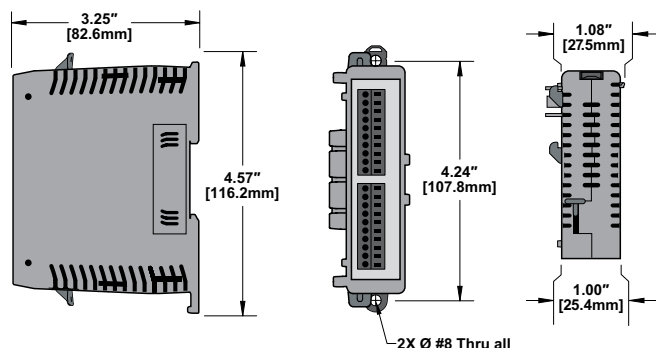

**NOTE:** When removing an expansion module, make sure there is room for the module to slide away from the system. Failure to do so will result in difficulty removing the module.

# BRX Analog Expansion Modules

## Analog Input Modules

Nine (9) analog input modules are available, with current or voltage inputs. Analog input module faceplates have a blue terminal bar to distinguish them as inputs, with symbols  $\swarrow$  or  $\blacktriangleleft$  to signify current or voltage, respectively.

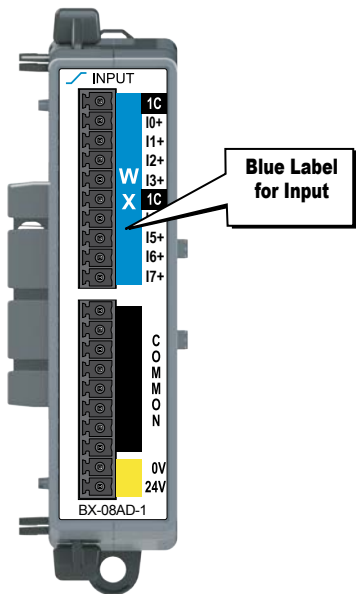

Analog Input Modules				
Part Number	Points	Input Type	Resolution	Price
<b><u>BX-04ADM-1</u></b>	4	Current Sink 0–20 mA, 4–20 mA	14-bit	\$182.00
<b><u>BX-04AD-1</u></b>	4	Current Sink 0–20 mA, 4–20 mA	16-bit	\$230.00
<b><u>BX-08AD-1</u></b>	8			\$255.00
<b><u>BX-16AD-1</u></b>	16			\$363.00
<b><u>BX-04AD-2B</u></b>	4	Voltage $\pm 10\text{VDC}$ , $\pm 5\text{VDC}$ , 0–5 VDC, 0–10 VDC	16-bit	\$230.00
<b><u>BX-08AD-2B</u></b>	8			\$255.00
<b><u>BX-16AD-2B</u></b>	16			\$363.00
<b><u>BX-04AD-3</u></b>	4	Current Sink 0–20mA, 4–20mA	16-bit	\$188.00
<b><u>BX-08AD-3</u></b>	8	Voltage $\pm 10\text{VDC}$ , $\pm 5\text{VDC}$ , 0–5VDC, 0–10VDC		\$212.00

## Temperature Input Module

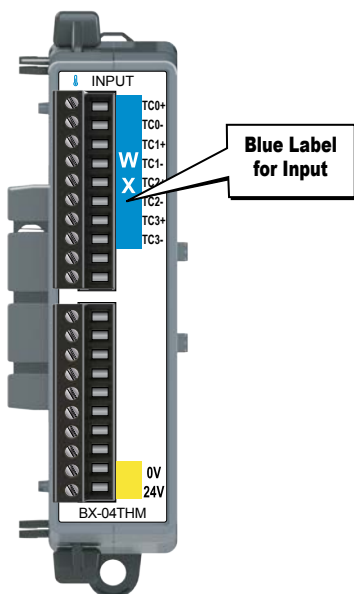

Six (6) temperature input modules are available, with thermocouple, RTD, and/or thermistor inputs. The thermocouple input modules can also be configured for millivolt-level voltage inputs, and the RTD input module can also be configured for resistance input. Temperature module faceplates have a blue terminal bar to distinguish them as inputs, and  $\updownarrow$  symbol to signify temperature.



Temperature Input Modules			
Part Number	Points	Input Type	Price
<b><u>BX-04THM</u></b>	4	Thermocouple	\$241.00
<b><u>BX-08THM</u></b>	8	Thermocouple	\$269.00
<b><u>BX-06RTD</u></b>	6	RTD	\$255.00
<b><u>BX-08NTC</u></b>	8	Thermistor	\$269.00
<b><u>BX-04UT</u></b>	4	Universal Temperature (Thermocouple, RTD, Thermistor supported)	\$211.00
<b><u>BX-08UT</u></b>	6	Universal Temperature (Thermocouple, RTD, Thermistor supported)	\$235.00

# BRX Analog Expansion Modules

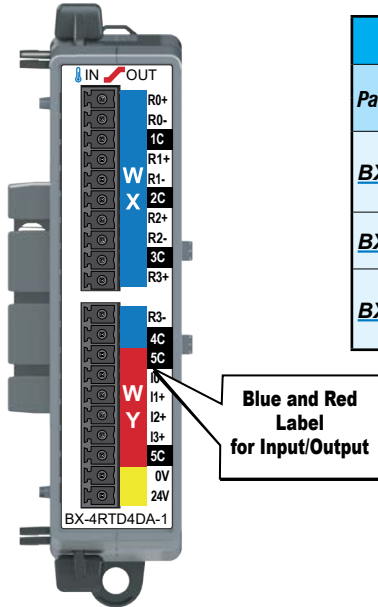

## Temperature/Analog Combo Module

Three (3) combination modules are available, with thermocouple, RTD or universal temperature inputs and current sourcing outputs. The thermocouple input modules can also be configured for millivolt-level voltage inputs, and the RTD input module can also be configured for resistance input. The Input/Output faceplate terminal bar is in blue and red, making it easy to distinguish between inputs and outputs, and the  and  symbols signify temperature and current, respectively.



Temperature Input / Analog Output Combo Modules					
Part Number	Points		Input Type	Output Type	Price
	Input	Output			
<a href="#">BX-4RTD4DA-1</a>	4	4	Resistance Temperature Detector (RTD)	Current Source 0–20mA, 4–20mA	\$472.00
<a href="#">BX-4THM4DA-1</a>	4	4	Thermocouple	Current Source 0–20mA, 4–20mA	\$472.00
<a href="#">BX-4UT4DA-3</a>	4	4	Universal Temperature	Current Source: 0–20mA, 4–20mA Voltage: ±10VDC, ±5VDC, 0–5VDC, 0–10VDC	\$412.00

## Temperature/Discrete Combo Module

Three (3) combination modules are available with universal temperature inputs and DC sinking, sourcing or relay outputs. The thermocouple inputs can also be configured for millivolt-level voltage inputs, and the RTD inputs can also be configured for resistance input. The Input/Output faceplate terminal bar is in blue and red, making it easy to distinguish between inputs and outputs, and the  and  symbols signify temperature and discrete signals, respectively.

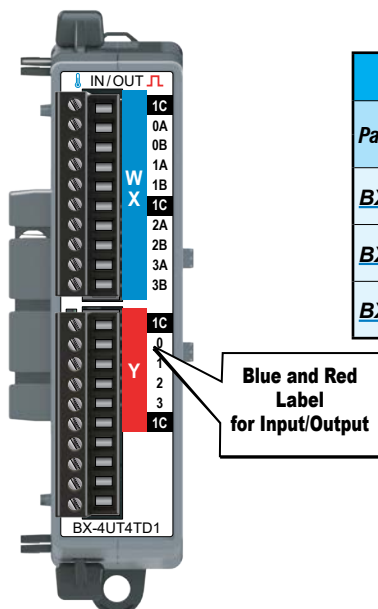

Temperature Input / Discrete Output Combo Modules					
Part Number	Points		Input Type	Output Type	Price
	Input	Output			
<a href="#">BX-4UT4TD1</a>	4	4	Universal Temperature	12–24 VDC Sinking	\$235.00
<a href="#">BX-4UT4TD2</a>	4	4		12–24 VDC Sourcing	\$235.00
<a href="#">BX-4UT4TR</a>	4	4		Relay Form A (SPST)	\$235.00

# BRX Analog Expansion Modules

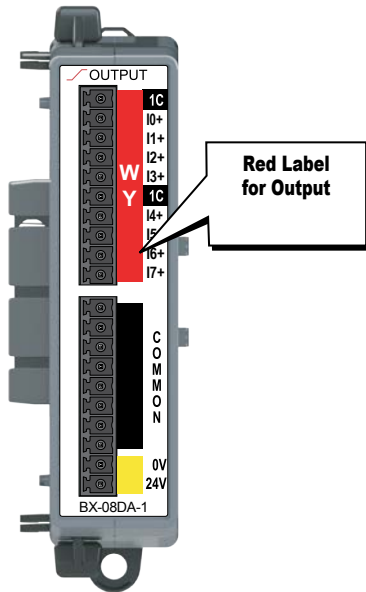

## Analog Output Modules

Six (6) analog output modules are available, in current and voltage outputs. Analog output module faceplates have a red terminal bar to distinguish them as outputs, with symbols  $\swarrow$  or  $\blacktriangle$  to signify current or voltage, respectively.

Analog Output Modules			
Part Number	Points	Output Type	Price
<a href="#"><u>BX-04DA-1</u></a>	4	Current Source 0-20 mA, 4-20 mA	\$269.00
<a href="#"><u>BX-08DA-1</u></a>	8		\$350.00
<a href="#"><u>BX-04DA-2B</u></a>	4	Voltage $\pm 10\text{VDC}$ , $\pm 5\text{VDC}$ , 0-5 VDC, 0-10 VDC	\$269.00
<a href="#"><u>BX-08DA-2B</u></a>	8		\$350.00
<a href="#"><u>BX-04DA-3</u></a>	4	Current Source 0-20mA, 4-20mA Voltage $\pm 10\text{VDC}$ , $\pm 5\text{VDC}$ , 0-5VDC, 0-10VDC	\$231.00
<a href="#"><u>BX-08DA-3</u></a>	8		\$294.00

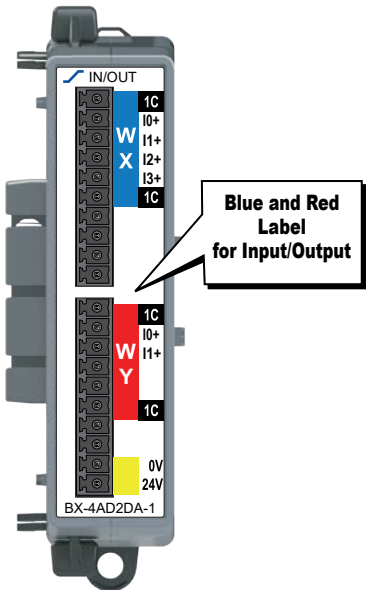

## Analog Combo Input / Output Modules

Six (6) analog input/output combo modules are available with current or voltage inputs and outputs. The Input/Output faceplate terminal bar is in blue and red, making it easy to distinguish between inputs and outputs. Symbols  $\swarrow$  and  $\blacktriangle$  signify current and voltage, respectively.

Analog Combo Input / Output Modules					
Part Number	Points		Input Type	Output Type	Price
	Input	Output			
<a href="#"><u>BX-2AD2DA-1</u></a>	2	2	Current Sink 0-20mA, 4-20mA	Current Source 0-20mA, 4-20mA	\$309.00
<a href="#"><u>BX-4AD2DA-1</u></a>	4	2			\$378.00
<a href="#"><u>BX-2AD2DA-2B</u></a>	2	2	Voltage $\pm 10\text{VDC}$ , $\pm 5\text{VDC}$ , 0-5VDC, 0-10VDC	Voltage $\pm 10\text{VDC}$ , $\pm 5\text{VDC}$ , 0-5VDC, 0-10VDC	\$309.00
<a href="#"><u>BX-4AD2DA-2B</u></a>	4	2			\$378.00
<a href="#"><u>BX-2AD2DA-3</u></a>	2	2	Current Source 0-20mA, 4-20mA Voltage $\pm 10\text{VDC}$ , $\pm 5\text{VDC}$ , 0-5VDC, 0-10VDC	Current Source 0-20mA, 4-20mA Voltage $\pm 10\text{VDC}$ , $\pm 5\text{VDC}$ , 0-5VDC, 0-10VDC	\$269.00
<a href="#"><u>BX-4AD4DA-3</u></a>	4	4			\$330.00

Expansion Module Support by Controller	
Controller Type	# Expansion Modules
<a href="#"><u>BX-DM1E-M</u></a>	8
<a href="#"><u>BX-DM1-10</u></a>	2
<a href="#"><u>BX-DM1E-10</u></a>	2
<a href="#"><u>BX-DM1-18</u></a>	4
<a href="#"><u>BX-DM1E-18</u></a>	8
<a href="#"><u>BX-DM1-36</u></a>	4
<a href="#"><u>BX-DM1E-36</u></a>	8
<a href="#"><u>BX-DMIO*</u></a>	8
<a href="#"><u>BX-EBC100*</u></a>	8
<a href="#"><u>BX-MBIO*</u></a>	8

\* Remote I/O controllers do not support Motion Control and Communications Modules.



# BRX Wiring Termination Options

## Terminal Block Connectors

The terminal block connectors are provided in kits of multiple connectors that are ordered as a single part number. There are 2 different types of kits to choose from; one kit for the five (5), eight (8) and 12-point discrete, and one

kit for the analog modules and 16-point discrete modules. The five (5), eight (8) and 12-point discrete module kits each have (3) 5-pin 5mm connectors. The 8-point modules will use only 2 of the 5-pin connectors.

The five (5) and 12-point modules will use all three connectors. The analog and 16-point digital module kits include (2) 10-pin 3.81 mm connectors.

## Terminal Block Connectors, 5, 8 and 12-Point Discrete Modules

Terminal Block Kits for 5-point, 8-point and 12-point Expansion Modules



**BX-RTB08 (Kit - 3 pieces)**



**BX-RTB08-1 (Kit - 3 pieces)**



**BX-RTB08-2 (Kit - 3 pieces)**

Terminal Block Specifications 5-, 8- & 12-Point Type			
Part Number Single Block Set of 3 Blocks	<b><i>BX-RTB05</i></b> <b><i>BX-RTB08</i></b>	<b><i>BX-RTB05-1</i></b> <b><i>BX-RTB08-1</i></b>	<b><i>BX-RTB05-2</i></b> <b><i>BX-RTB08-2</i></b>
Price (Single Block)	\$8.50	\$7.00	\$8.00
Price (Kit)	\$15.00	\$14.50	\$15.00
Connector Type	Screw Type - 90-degree	Spring Clamp Type - 180-degree	Screw Type - 180-degree
Wire Exit	180-degree	180-degree	180-degree
Pitch	5.0 mm	5.0 mm	5.0 mm
Screw Size	M2.5	N/A	M2.5
Screw Torque Recommended	< 3.98 lb-in (0.45 N·m)	N/A	< 3.98 lb-in (0.45 N·m)
Screwdriver Blade Width	3.5 mm	3.5 mm	3.5 mm
Wire Gauge (Single Wire)	28-12 AWG	28-14 AWG	28-12 AWG
Wire Gauge (Dual Wire)	28-16 AWG	28-16 AWG (Dual Wire Ferrule Required)	28-16 AWG
Wire Strip Length	0.3 in (7.5 mm)	0.37 in (9.5 mm)	0.3 in (7.5 mm)
Equiv. Dinkle P/N	5ESDV-05P-BK	5ESDSR-05P-BK	5ESDF-05P-BK

## Terminal Block Connectors, Analog Modules and 16-Point Discrete Modules

Terminal Block Kits for Analog and 16-point Discrete Expansion Modules



**BX-RTB10 (Kit - 2 pieces)**

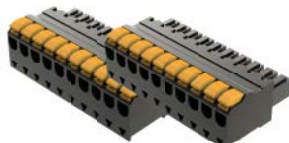

**BX-RTB10-1 (Kit - 2 pieces)**



**BX-RTB10-2 (Kit - 2 pieces)**

Terminal Block Specifications 16-Point Type			
Part Number	<b><i>BX-RTB10</i></b>	<b><i>BX-RTB10-1</i></b>	<b><i>BX-RTB10-2</i></b>
Price (Kit)	\$21.50	\$24.00	\$22.50
Connector Type	Screw Type 90-degree	Spring Clamp Type 180-degree	Screw Type 180-degree
Wire Exit	180-degree	180-degree	180-degree
Pitch	3.81 mm	3.81 mm	3.81 mm
Screw Size	M2	N/A	M2
Screw Torque Recommended	<1.77 lb-in (0.2 N·m)	N/A	<1.77 lb-in (0.2 N·m)
Screwdriver Blade Width	2.5 mm	2.5 mm	2.5 mm
Wire Gauge (Single Wire)	28-16 AWG	26-18 AWG	30-16 AWG
Wire Gauge (Dual Wire)	28-18 AWG	30-20 AWG (Dual Wire Ferrule Required)	30-18 AWG
Wire Strip Length	0.24 in (6mm)	0.35 in (9mm)	0.26 in (6.5 mm)
Equiv. Dinkle P/N	EC381V-10P-BK	ESC381V-10-BK	EC381F-10P-BK



**NOTE:** BX-RTB10 terminal blocks are included with Temperature Input modules.

# BRX Wiring Termination Options

## ZIPLink Wiring System

BRX expansion modules can be quickly connected to convenient **ZIPLink** remote terminal blocks for ease of wiring I/O devices. Your **ZIPLink** selection is dependent on the number of expansion module terminal points. The following tables list the connector options.



### 8-Point BRX Discrete Expansion Module ZIPLink Selector

Expansion Module Part No.	ZIPLink Module	ZIPLink Module Part No.	Qty Needed	ZIPLink Cable Part No.*	Qty Needed
<a href="#">BX-08ND3</a>	Feedthrough	ZL-RTB20 (Standard) OR ZL-RTB20-1 (Compact)	1	ZL-BXEM-CBL10 ZL-BXEM-CBL10-1 ZL-BXEM-CBL10-2	1
<a href="#">BX-08NF3</a>					
<a href="#">BX-08NA</a>					
<a href="#">BX-08NB</a>					
<a href="#">BX-08TD1</a>					
<a href="#">BX-08TD2</a>					
<a href="#">BX-08TR**</a>					
<a href="#">BX-08TRZ**</a>					
<a href="#">BX-08TA</a>					
<a href="#">BX-08CD3R**</a>					

\* Select cable length: Blank = 0.5 m, -1 = 1.0m, -2 = 2.0m.

Available pigtail cables: [ZL-BXEM-CBL10-1P](#) = 1.0 m, [ZL-BXEM-CBL10-2P](#) = 2.0 m.

\*\* The relay outputs are derated not to exceed 2A per common when used with the **ZIPLink** wiring system.

### 12 & 5-Point BRX Discrete Expansion Module ZIPLink Selector

Expansion Module Part No.	ZIPLink Module	ZIPLink Module Part No.	Qty Needed	ZIPLink Cable Part No.*	Qty Needed
<a href="#">BX-12ND3</a>	Feedthrough	ZL-RTB20 (Standard) OR ZL-RTB20-1 (Compact)	1	ZL-BXEM-CBL15 ZL-BXEM-CBL15-1 ZL-BXEM-CBL15-2	1
<a href="#">BX-12NA</a>					
<a href="#">BX-12NB</a>					
<a href="#">BX-12TD1</a>					
<a href="#">BX-12TD2</a>					
<a href="#">BX-12TR**</a>					
<a href="#">BX-05TRS</a>					
<a href="#">BX-12TA</a>					
<a href="#">BX-12CD3D1</a>					
<a href="#">BX-12CD3D2</a>					

\* Select cable length: Blank = 0.5 m, -1 = 1.0m, -2 = 2.0m.

Available pigtail cables: [ZL-BXEM-CBL15-1P](#) = 1.0 m, [ZL-BXEM-CBL15-2P](#) = 2.0 m.

\*\* The relay outputs are derated not to exceed 2A per common when used with the **ZIPLink** wiring system.



# BRX Wiring Termination Options

16-Point BRX Discrete Expansion Module ZIPLink Selector							
Expansion Module Part No.	ZIPLink Module	ZIPLink Module Part No.	Qty Needed	ZIPLink Cable Part No. *	Qty Needed		
<b><u>BX-16ND3</u></b>	Sensor	<u>ZL-LTB16-24-1</u>	1	<u>ZL-BXEM-CBL20</u> <u>ZL-BXEM-CBL20-1</u> <u>ZL-BXEM-CBL20-2</u>	1		
	Feedthrough	<u>ZL-RTB20</u> (Standard) OR <u>ZL-RTB20-1</u> (Compact)	1				
<b><u>BX-16NF3</u></b>	Feedthrough						
<b><u>BX-16NA</u></b>							
<b><u>BX-16NB</u></b>	Feedthrough						
<b><u>BX-16TD1</u></b>							
<b><u>BX-16TD2</u></b>	Relay (Sourcing)					<u>ZL-RRL16-24-1</u> , <u>ZL-RRL16W-24-1</u> , <u>ZL-RRL16F-24-1</u> , <u>ZL-RRL16HDF-24-1</u>	1
	Relay (Sinking)					<u>ZL-RRL16-24-2</u> , <u>ZL-RRL16W-24-2</u> , <u>ZL-RRL16F-24-2</u> , <u>ZL-RRL16HDF-24-2</u>	1
<b><u>BX-16TF2</u></b>	Feedthrough					<u>ZL-RTB20</u> (Standard) OR <u>ZL-RTB20-1</u> (Compact)	1
<b><u>BX-16TR**</u></b>							
<b><u>BX-16TRZ**</u></b>							
<b><u>BX-16CD3D1</u></b>							
<b><u>BX-16CD3D2</u></b>							
<b><u>BX-16CF3F2</u></b>							

\* Select cable length: Blank = 0.5 m, -1 = 1.0m, -2 = 2.0m.

Available pigtail cables: ZL-BXEM-CBL20-1P = 1.0 m, ZL-BXEM-CBL20-2P = 2.0 m.

\*\* The relay outputs are derated not to exceed 2A per common when used with the ZIPLink wiring system.

32-Point BRX Discrete Expansion Module ZIPLink Selector					
Expansion Module Part No.	ZIPLink Module	ZIPLink Module Part No.	Qty Needed	ZIPLink Cable Part No. *	Qty Needed
<b><u>BX-32ND3</u></b>	Sensor	<u>ZL-LTB32-24-1</u>	1	<u>ZL-D24-CBL40</u> <u>ZL-D24-CBL40-1</u> <u>ZL-D24-CBL40-2</u>	1
	Feedthrough	<u>ZL-RTB40</u> (Standard) OR <u>ZL-RTB40-1</u> (Compact)	1		
<b><u>BX-32TD1</u></b>	Feedthrough				
<b><u>BX-32TD2</u></b>					

\* Select cable length: Blank = 0.5 m, -1 = 1.0m, -2 = 2.0m.

Available pigtail cables: ZL-D24-CBL40-1P = 1.0 m, ZL-D24-CBL40-2P = 2.0 m.

Suffix -X indicates 45° cable connector angle. Non -X indicates 180° cable connector angle.

16-Point BRX High Speed Expansion Module ZIPLink Selector					
Expansion Module Part No.	ZIPLink Module	ZIPLink Module Part No.	Qty Needed	ZIPLink Cable Part No. *	Qty Needed
<b><u>BX-HSIO4</u></b>	Feedthrough	<u>ZL-RTB40</u> (Standard) OR <u>ZL-RTB40-1</u> (Compact)	1	<u>ZL-BX-CBL40-S</u> <u>ZL-BX-CBL40-1S</u>	1

# BRX Wiring Termination Options

BRX Analog and Temperature Expansion Module ZIPLink Selector					
Expansion Module Part No.	ZIPLink Module	ZIPLink Module Part No.	Qty Needed	ZIPLink Cable Part No. <sup>1</sup>	Qty Needed
<a href="#">BX-04ADM-1</a>	Feedthrough	ZL-RTB20 (Standard) OR ZL-RTB20-1 (Compact)	1	<a href="#">ZL-BXEM-CBL20</a> <a href="#">ZL-BXEM-CBL20-1</a> <a href="#">ZL-BXEM-CBL20-2</a>	1
<a href="#">BX-04AD-1</a>					
<a href="#">BX-08AD-1</a>					
<a href="#">BX-16AD-1</a>					
<a href="#">BX-04AD-2B</a>					
<a href="#">BX-08AD-2B</a>					
<a href="#">BX-16AD-2B</a>					
<a href="#">BX-04DA-1</a>					
<a href="#">BX-08DA-1</a>					
<a href="#">BX-04DA-2B</a>					
<a href="#">BX-08DA-2B</a>					
<a href="#">BX-2AD2DA-1</a>					
<a href="#">BX-4AD2DA-1</a>					
<a href="#">BX-2AD2DA-2B</a>					
<a href="#">BX-4AD2DA-2B</a>					
<a href="#">BX-08AD-3</a>				<a href="#">ZL-BXEM-CBL10</a> <a href="#">ZL-BXEM-CBL10-1</a> <a href="#">ZL-BXEM-CBL10-2</a>	1
<a href="#">BX-08DA-3</a>				Temperature Input modules are not supported by the ZIPLink wiring system.	
<a href="#">BX-2AD2DA-3</a>					
<a href="#">BX-4AD4DA-3</a>					
<a href="#">BX-04THM</a>					
<a href="#">BX-08THM</a>					
<a href="#">BX-06RTD</a>					
<a href="#">BX-08NTC</a>					
<a href="#">BX-04UT</a>					
<a href="#">BX-08UT</a>					
<a href="#">BX-4THM4DA-1</a>					
<a href="#">BX-4RTD4DA-1</a>					
<a href="#">BX-4UT4DA-3</a>					
<a href="#">BX-4UT4TD1</a>					
<a href="#">BX-4UT4TD2</a>					
<a href="#">BX-4UT4TR</a>					

1. Select cable length: Blank = 0.5 m, -1 = 1.0m, -2 = 2.0m.

Available pigtail cables: [ZL-BXEM-CBL20-1P](#) = 1.0 m, [ZL-BXEM-CBL20-2P](#) = 2.0 m.