







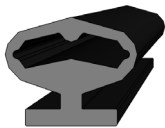
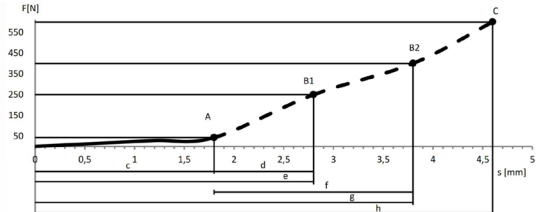
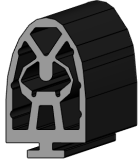
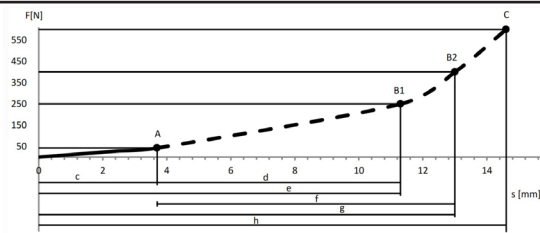

ASO Safety Solutions

SENTIR Edges

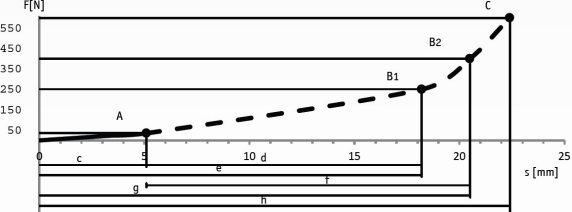
Selecting the Edge Profile

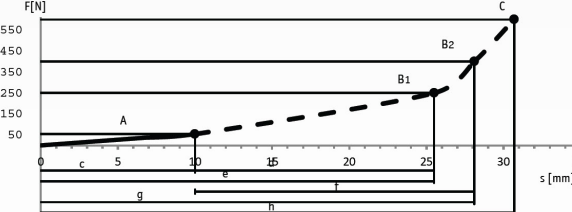
ASO Safety Solutions offers several sizes of safety edges to fit most applications, including automatic gate, door, and machine applications. The size (profile) of the edge should be selected based on the application and overtravel permitted by the profile. If the edge experiences overtravel beyond the allowed amount, damage may occur. An additional important deciding factor to consider when determining which profile to use is sensitivity. Sensitivity is the amount of force required to activate the unit.

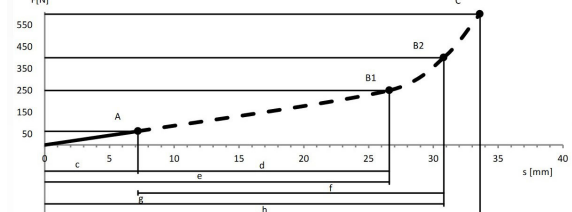
Where greater actuating forces or overtravel requirements are needed, a safety bumper may be the preferred approach.

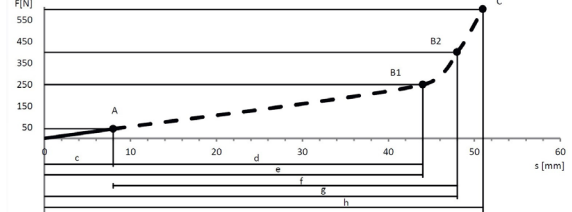
Profile Series	Test Speed (10 mm/sec [0.4 in/sec]*		Tested according to DIN EN ISO 13856-2, Test Unit round 80mm, Actuating Point C3, Temp 20°C
15mm x 10mm [0.6 in x 0.4 in] 	Force (F) Required for Actuation (A)	42.9 N [9.64 lbf]	
	Actuation Distance c	1.8 mm [0.07 in]	
	Overtravel Distance d to 250N	1.0 mm [0.04 in]	
	Overtravel Distance f to 400N	2.0 mm [0.08 in]	
	Overtravel Distance h-c to 600N	2.8 mm [0.11 in]	
15mm x 25mm [0.6 in x 1.0 in] 	Force (F) Required for Actuation (A)	43N [9.67 lbf]	
	Actuation Distance c	3.7 mm [0.15 in]	
	Overtravel Distance d to 250N	7.6 mm [0.30 in]	
	Overtravel Distance f to 400N	9.3 mm [0.37 in]	
	Overtravel Distance h-c to 600N	10.9 mm [0.43 in]	
25mm x 30mm [1.0 in x 1.2 in] 	Force (F) Required for Actuation (A)	35N [7.87 lbf]	
	Actuation Distance c	5.1 mm [0.20 in]	
	Overtravel Distance d to 250N	13.1 mm [0.52 in]	
	Overtravel Distance f to 400N	15.4 mm [0.61 in]	
	Overtravel Distance h-c to 600N	17.3 mm [0.68 in]	
25mm x 30mm [1.0 in x 1.2 in] 	Force (F) Required for Actuation (A)	54.3 N [12.21 lbf]	
	Actuation Distance c	10.0 mm [0.39 in]	
	Overtravel Distance d to 250N	15.5 mm [0.61 in]	
	Overtravel Distance f to 400N	18.1 mm [0.71 in]	
	Overtravel Distance h-c to 600N	20.7 mm [0.81 in]	
25mm x 45mm [1.0 in x 1.8 in] 	Force (F) Required for Actuation (A)	63.1 N [14.19 lbf]	
	Actuation Distance c	7.2 mm [0.28 in]	
	Overtravel Distance d to 250N	19.4 mm [0.76 in]	
	Overtravel Distance f to 400N	23.6 mm [0.93 in]	
	Overtravel Distance h-c to 600N	26.4 mm [1.04 in]	
30mm x 70mm [1.2 in x 2.8 in] 	Force (F) Required for Actuation (A)	44N [9.89 lbf]	
	Actuation Distance c	8.0 mm [0.31 in]	
	Overtravel Distance d to 250N	36.0 mm [1.42 in]	
	Overtravel Distance f to 400N	40.0 mm [1.57 in]	
	Overtravel Distance h-c to 600N	43.0 mm [1.69 in]	

* For other speed data, please refer to product data sheets.

ASO Safety Solutions



15mm x 10mm SENTIR Edges (factory assembled)

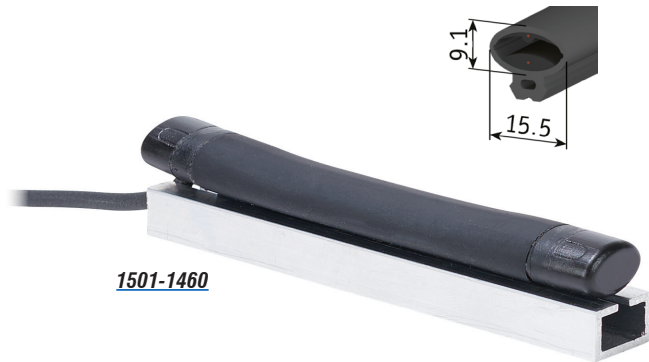

1501-1460

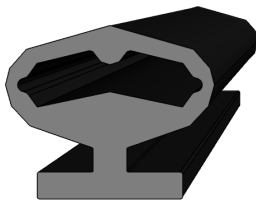

The SENTIR edge safety contact edges of ASO Safety Solutions are pressure-sensitive sensors applied to ensure the safety of closing edges at possible crushing or shearing points which are prone to accidents. They may be installed near automatic gates, machines and other facilities for handling equipment or moving stage elements in order to protect individuals from bodily harm or machinery from damage.

Features

- Optimized material properties guarantee fast switching results
- 12 edge lengths available
- Can wire in 2-wire circuits
- Mounting rails included
- Factory assembled (cannot be modified)

ASO Safety Contact Edges - 15mm x 10mm						
Part Number	Price	Profile	Length	End Caps	Aluminum Mounting Rail	Drawing
1501-1460	\$83.00	15mm x 10mm [0.59 in x 0.39 in]	4in [0.102 m]	8.2K ohm terminating resistor and 2.5 m [8.2 ft] cable with flying pigtail leads included. These are factory installed.	Included	PDF
1501-1461	\$86.00		6in [0.152 m]			PDF
1501-1462	\$88.00		8in [0.203 m]			PDF
1501-1463	\$90.00		1ft [0.305 m]			PDF
1501-1464	\$92.00		1.2 ft [0.366 m]			PDF
1501-1465	\$94.00		1.5 ft [0.457 m]			PDF
1501-1466	\$100.00		1.8 ft [0.549 m]			PDF
1501-1467	\$102.00		2ft [0.61 m]			PDF
1501-1468	\$104.00		2.5 ft [0.762 m]			PDF
1501-1469	\$107.00		3 ft [0.914 m]			PDF
1501-1470	\$112.00		3.5 ft [1.067 m]			PDF
1501-1471	\$115.00		4ft [1.219 m]			PDF

ASO Safety Solutions



15mm x 10mm SENTIR Edges (factory assembled)

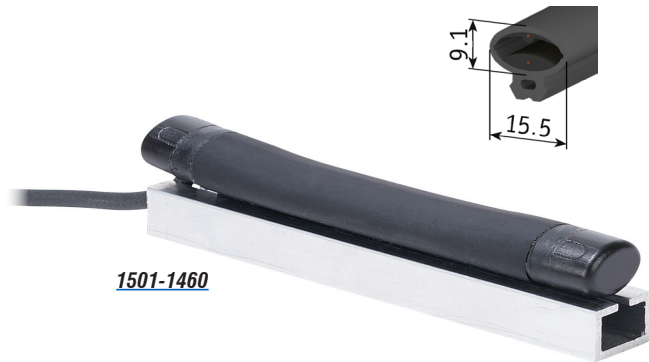

1501-1460

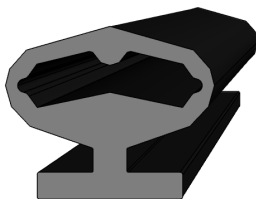

The SENTIR edge safety contact edges of ASO Safety Solutions are pressure-sensitive sensors applied to ensure the safety of closing edges at possible crushing or shearing points which are prone to accidents. They may be installed near automatic gates, machines and other facilities for handling equipment or moving stage elements in order to protect individuals from bodily harm or machinery from damage.

Features

- Optimized material properties guarantee fast switching results
- 12 edge lengths available
- Can wire in 2-wire circuits
- Mounting rails included
- Factory assembled (cannot be modified)

ASO Safety Contact Edges - 15mm x 10mm						
Part Number	Price	Profile	Length	End Caps	Aluminum Mounting Rail	Drawing
1501-1460	\$83.00	15mm x 10mm [0.59 in x 0.39 in]	4in [0.102 m]	8.2K ohm terminating resistor and 2.5 m [8.2 ft] cable with flying pigtail leads included. These are factory installed.	Included	PDF
1501-1461	\$86.00		6in [0.152 m]			PDF
1501-1462	\$88.00		8in [0.203 m]			PDF
1501-1463	\$90.00		1ft [0.305 m]			PDF
1501-1464	\$92.00		1.2 ft [0.366 m]			PDF
1501-1465	\$94.00		1.5 ft [0.457 m]			PDF
1501-1466	\$100.00		1.8 ft [0.549 m]			PDF
1501-1467	\$102.00		2ft [0.61 m]			PDF
1501-1468	\$104.00		2.5 ft [0.762 m]			PDF
1501-1469	\$107.00		3 ft [0.914 m]			PDF
1501-1470	\$112.00		3.5 ft [1.067 m]			PDF
1501-1471	\$115.00		4ft [1.219 m]			PDF

Safety Products



Warning: Safety products sold by AutomationDirect are Safety components only. The purchaser/installer is solely responsible for the application of these components and ensuring all necessary steps have been taken to assure each application and use meets all performance and applicable safety requirements and/or local, national and/or international safety codes as required by the application. AutomationDirect cannot certify that our products, used solely or in conjunction with other AutomationDirect or other vendors' products, will assure safety for any application. Any person using or applying any products sold by AutomationDirect is responsible for learning the safety requirements for their individual application and applying them, and therefore assumes all risks, and accepts full and complete responsibility, for the selection and suitability of the product for their respective application.

AutomationDirect does not provide design or consulting services, and cannot advise whether any specific application or use of our products would ensure compliance with the safety requirements for any application.