









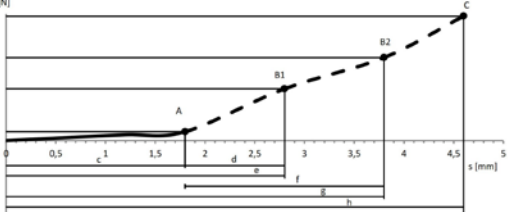

ASO Safety Solutions

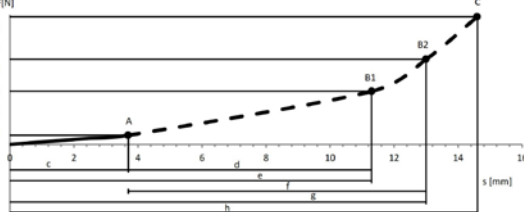
SENTIR Edges

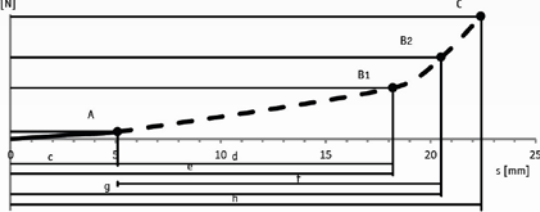
Selecting the Edge Profile

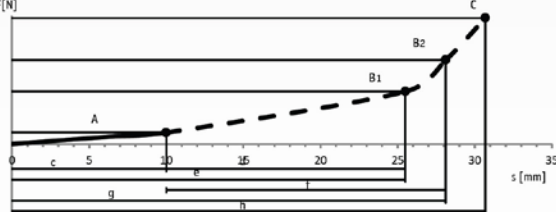
ASO Safety Solutions offers several sizes of safety edges to fit most applications, including automatic gate, door, and machine applications. The size (profile) of the edge should be selected based on the application and overtravel permitted by the profile. If the edge experiences overtravel beyond the allowed amount, damage may occur. An additional important deciding factor to consider when determining which profile to use is sensitivity. Sensitivity is the amount of force required to activate the unit.

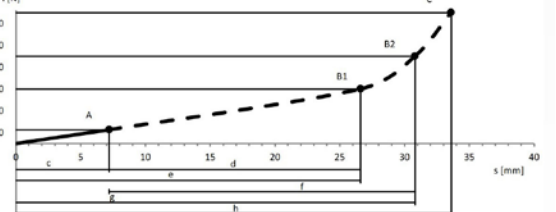
Where greater actuating forces or overtravel requirements are needed, a safety bumper may be the preferred approach.

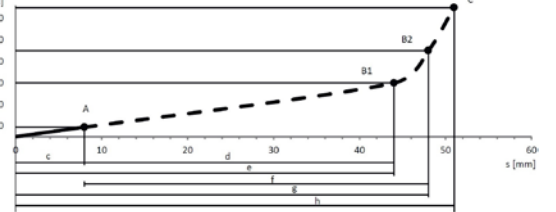
Profile Series	Test Speed (10 mm/sec [0.4 in/sec])*		Tested according to DIN EN ISO 13856-2, Test Unit round 80mm, Actuating Point C3, Temp 20°C
15mm x 10mm [0.6 in x 0.4 in] 	Force (F) Required for Actuation (A)	42.9 N [9.64 lbf]	
	Actuation Distance c	1.8 mm [0.07 in]	
	Overtravel Distance d to 250N	1.0 mm [0.04 in]	
	Overtravel Distance f to 400N	2.0 mm [0.08 in]	
	Overtravel Distance h-c to 600N	2.8 mm [0.11 in]	
15mm x 25mm [0.6 in x 1.0 in] 	Force (F) Required for Actuation (A)	43N [9.67 lbf]	
	Actuation Distance c	3.7 mm [0.15 in]	
	Overtravel Distance d to 250N	7.6 mm [0.30 in]	
	Overtravel Distance f to 400N	9.3 mm [0.37 in]	
	Overtravel Distance h-c to 600N	10.9 mm [0.43 in]	
25mm x 30mm [1.0 in x 1.2 in] 	Force (F) Required for Actuation (A)	35N [7.87 lbf]	
	Actuation Distance c	5.1 mm [0.20 in]	
	Overtravel Distance d to 250N	13.1 mm [0.52 in]	
	Overtravel Distance f to 400N	15.4 mm [0.61 in]	
	Overtravel Distance h-c to 600N	17.3 mm [0.68 in]	
25mm x 30mm [1.0 in x 1.2 in] 	Force (F) Required for Actuation (A)	54.3 N [12.21 lbf]	
	Actuation Distance c	10.0 mm [0.39 in]	
	Overtravel Distance d to 250N	15.5 mm [0.61 in]	
	Overtravel Distance f to 400N	18.1 mm [0.71 in]	
	Overtravel Distance h-c to 600N	20.7 mm [0.81 in]	
25mm x 45mm [1.0 in x 1.8 in] 	Force (F) Required for Actuation (A)	63.1 N [14.19 lbf]	
	Actuation Distance c	7.2 mm [0.28 in]	
	Overtravel Distance d to 250N	19.4 mm [0.76 in]	
	Overtravel Distance f to 400N	23.6 mm [0.93 in]	
	Overtravel Distance h-c to 600N	26.4 mm [1.04 in]	
30mm x 70mm [1.2 in x 2.8 in] 	Force (F) Required for Actuation (A)	44N [9.89 lbf]	
	Actuation Distance c	8.0 mm [0.31 in]	
	Overtravel Distance d to 250N	36.0 mm [1.42 in]	
	Overtravel Distance f to 400N	40.0 mm [1.57 in]	
	Overtravel Distance h-c to 600N	43.0 mm [1.69 in]	

* For other speed data, please refer to product data sheets.

ASO Safety Solutions

30mm x 70mm SENTIR Edges and End Caps



1502-6230

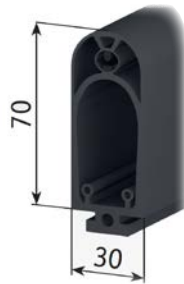

SENTIR safety contact edges are pressure-sensitive sensors used to ensure the safety of closing edges at possible crushing or shearing points which are prone to accidents. They may be installed near automatic gates, machines and other facilities for handling equipment to detect conditions that could cause bodily harm or damage machinery.

Features

- Optimized material properties guarantee fast switching results.
- 4 edge lengths available that can be easily cut to fit any application.
- Can wire in 2-wire or 4-wire circuits.
- Includes aluminum mounting rail.
- Reference example connection drawings for easy product selection.



1804-4000

M8 Connector
2

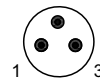

Use pins 1 and 3 for continuity.



1804-3990

ASO Safety Contact Edges - 30mm x 70mm						
Part Number	Price	Profile	Length	End Caps	Aluminum Mounting Rail	Drawing
1502-6230	\$56.00	30mm x 70mm	2ft [0.610 m]	End caps not included; choose from table below	Included	PDF
1502-6231	\$122.00	[1.18 in x 2.76 in]	5ft [1.52 m]		Included	PDF



1804-2666

ASO Safety Contact Edge End Caps - 30mm x 70mm				
Part Number	Price	Description	Connection	Drawing
1804-4000	\$24.50	End cap for 30mm x 70mm safety contact edges	3-pin female M8 connector 1.65 ft [0.5 m] cable length	PDF
1804-3990	\$24.50	End cap for 30mm x 70mm safety contact edges	3-pin male M8 connector 1.65 ft [0.5 m] cable length	PDF
1804-2666	\$16.00	Terminating resistor end cap for 30mm x 70mm safety contact edges, 8.2 kΩ	NA	PDF



9501-0160

ASO Safety Solutions Industrial Shears				
Part Number	Price	Description	Use With	Contents
9501-0160	\$93.00	Stainless steel industrial shears	Safety contact edges	1 shear

ASO Safety Solutions

30mm x 70mm SENTIR Edges and End Caps



Selection

Use the following Example Connections drawings to help you select the correct components for your system.

Example Connections - 30mm x 70mm edges and end caps

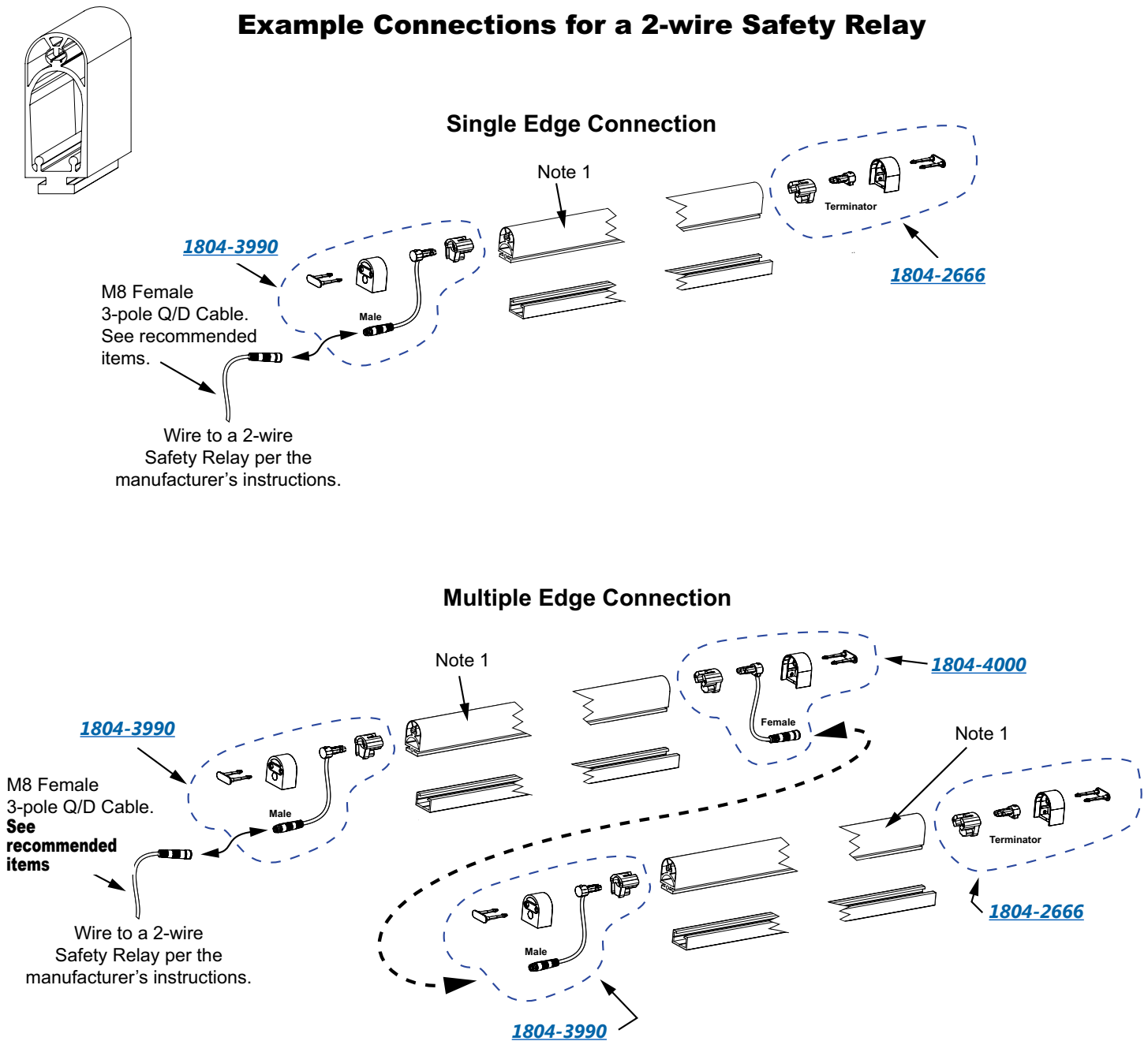

Note 1: [1502-6230](#) 2' edge (mounting rail included)
[1502-6231](#) 5' edge (mounting rail included)

ASO Safety Solutions 30mm x 70mm SENTIR Edges and End Caps



Example Connections - 30mm x 70mm edges and end caps

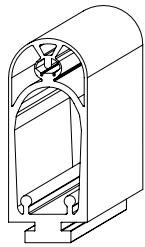

Example Connections for a 4-wire Safety Relay

Single Edge Connection

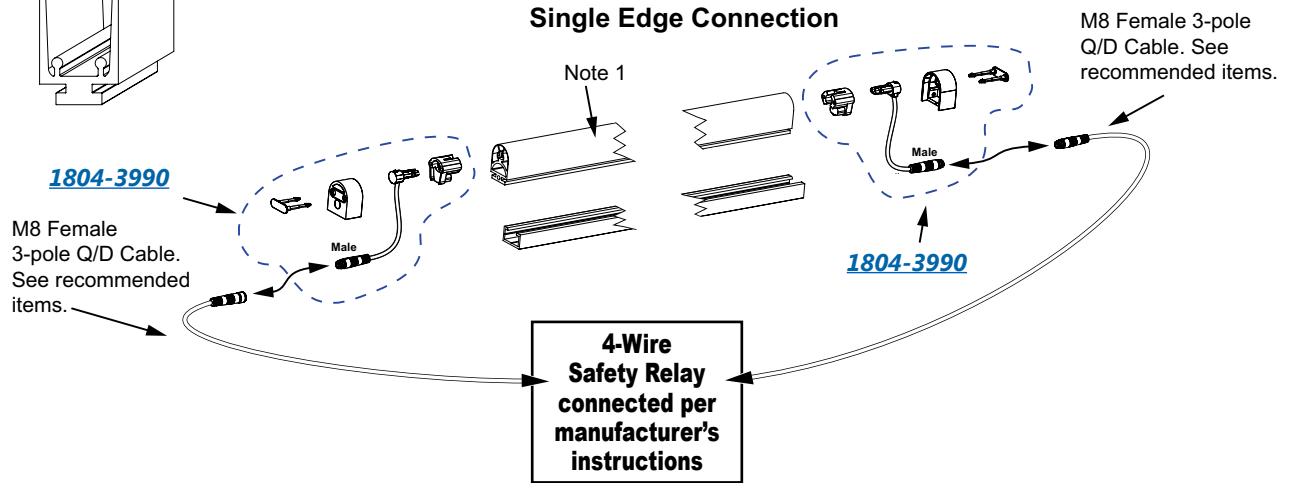

Multiple Edge Connection

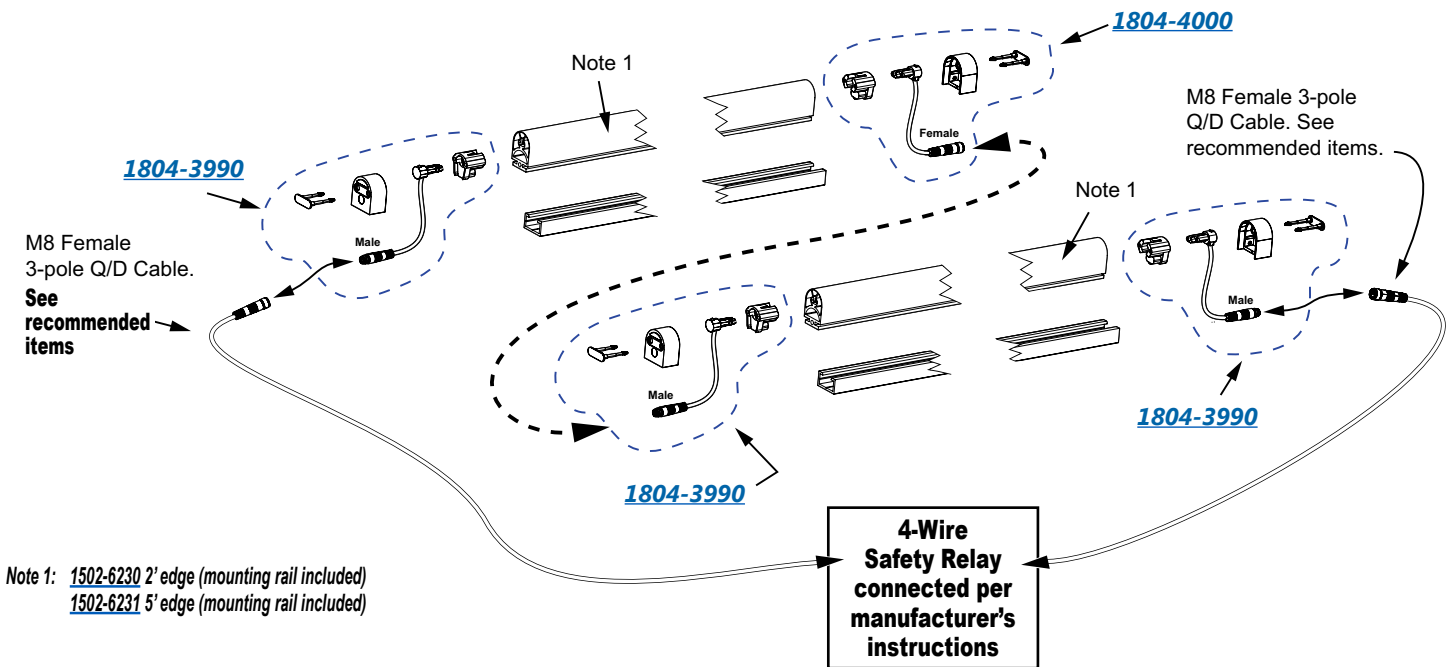

Note 1: [1502-6230](#) 2' edge (mounting rail included)
[1502-6231](#) 5' edge (mounting rail included)

ASO Safety Solutions



30mm x 70mm SENTIR Edges and End Caps

SENTIR 30mm x 70mm Edges	
	<i>General Specifications</i>
Material	TPE
Material Hardness	68 Shore A
Weight (per meter)	0.44 kg/m [0.31 lb/ft]
Protection Class (Enclosure)	IP65
Switching Cycles	>30,000 [UL 325]
Switching Angle	±45°
Actuation Resistance	≤ 500Ω
Actuation Force	44N @ 10mm/s [0.4in/s] approach speed
Mechanical Life	10,000 cycles
Electrical Capacity	24VDC, 10mA
Max. Temperature Range	-25° to +75°C [-13° to +167°F]
Operating Temperature	-10° to +50°C [+14° to +122°F]
Max. Series Connection	5 contact edges or 100m [328.08 ft] based on the ASO safety relay 1114-0210
Inactive End Region with Higher Forces	30mm [1.18 in]
Connection Cables	LIY11Y 2 x 0.34 mm ² (22AWG)
Cable Material	PUR matte black
Agency Approvals	UL Recognized file E341185, CE

Safety Products



Warning: Safety products sold by AutomationDirect are Safety components only. The purchaser/installer is solely responsible for the application of these components and ensuring all necessary steps have been taken to assure each application and use meets all performance and applicable safety requirements and/or local, national and/or international safety codes as required by the application. AutomationDirect cannot certify that our products, used solely or in conjunction with other AutomationDirect or other vendors' products, will assure safety for any application. Any person using or applying any products sold by AutomationDirect is responsible for learning the safety requirements for their individual application and applying them, and therefore assumes all risks, and accepts full and complete responsibility, for the selection and suitability of the product for their respective application.

AutomationDirect does not provide design or consulting services, and cannot advise whether any specific application or use of our products would ensure compliance with the safety requirements for any application.