

# ACUAMP® ACSL Series AC Current Switches

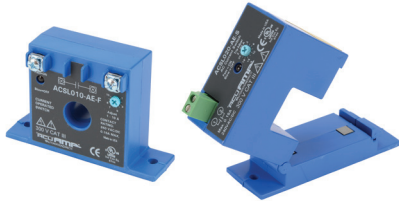

The ACSL series current sensing switches provide a current operated solid-state contact powered from the monitored circuit. The trip point adjustment uses a single turn potentiometer, allowing the installer to set the trip point without the monitored load present. The sensor installs over the conductor.

## Applications

### AC motor loads

- Set the contact to close at normal running current level and it will open if the drive belt breaks or comes off the sheaves.
- Monitor up to 150A loads.

### Critical lighting loads

- Monitor security lighting and water navigational indicators.

### Heating loads

- Receive independent verification that an element is working properly.
- Monitor drying and curing processes remotely.

## Features

- Single-turn potentiometer setpoint selection with trip point indicated on the labeling
- Setpoint can be set without monitored load present
- Two second delay before contact action on initial energization allowing the output to ignore motor inrush current.
- Status LED provides visual indication of setpoint trip and contact action.
- Self-powered operation cuts installation time and operating costs.
- Output is magnetically isolated from the input for safety.
- Choose either split-core or fixed core enclosure style. Split core packages allow easy installation on existing systems; fixed core enclosures offer a more compact package for OEM or new installations.
- Built-in feet with optional 35mm DIN rail adapter available.
- Five-year warranty



## ACSL AC Current Operated Switches

Part Number	Description	Trip Range Adjustment	Pcs/Pkg	Wt (lb)	Price
<b>ACSL010-AE-F</b>	AcuAMP AC current switch, fixed core, 0-150A sensing range, 1-10A adjustable trip point, single-turn scaled potentiometer, solid state switch, N.O. output, 0.15A @ 240 VAC/VDC output rating.	1-10A	1	0.25	\$94.00
<b>ACSL020-AE-S</b>	AcuAMP AC current switch, split core, 0-150A sensing range, 2-20A adjustable trip point, single-turn scaled potentiometer, solid state switch, N.O. output, 0.15A @ 240 VAC/VDC output rating.	2-20A	1	0.30	\$109.00
<b>ACSL050-AE-F</b>	AcuAMP AC current switch, fixed core, 0-150A sensing range, 10-50A adjustable trip point, single-turn scaled potentiometer, solid state switch, N.O. output, 0.15A @ 240 VAC/VDC output rating.	10-50A	1	0.25	\$94.00
<b>ACSL050-AE-S</b>	AcuAMP AC current switch, split core, 0-150A sensing range, 20-50A adjustable trip point, single-turn scaled potentiometer, solid state switch, N.O. output, 0.15A @ 240 VAC/VDC output rating.	20-50A	1	0.30	\$109.00
Accessories					
<b>DRA-2B</b>	35mm DIN rail adapters, 1.70"x0.45"x0.83" [43.7x11.4x21.0 mm]		2	0.40	\$6.00

## ACSL Series Specifications

<b>Power Supply</b>	None - self powered
<b>Output Switch</b>	Solid state, normally open
<b>Switch Rating</b>	0.15 A @ 240 VAC/VDC
<b>Off State Leakage</b>	<10µA
<b>Response Time</b>	100ms
<b>Inrush Delay</b>	2 second delay before output changes state upon first energization
<b>Hysteresis</b>	Minimum 3% of setpoint
<b>Setpoint (Trip Point) Ranges</b>	Ranges from 1-50A
<b>Setpoint (Trip Point) Adjust</b>	3/4-turn potentiometer
<b>Isolation Voltage</b>	UL Tested to 3,000VAC
<b>Monitored Circuit</b>	600VAC line-to-line max. 0-150A
<b>Frequency Range</b>	50-60 Hz
<b>Sensing Aperture</b>	0.55" (14mm) fixed core, 0.85" [21.6 mm] split core
<b>Case</b>	UL94V-0 Flammability Rating
<b>Environmental</b>	Operating Temperature: -4 to 122°F [-20 to 50°C]
	Relative Humidity: 0-95% RH, Non-condensing
	Pollution Degree 2
<b>Certifications</b>	Altitude to 2000 meters
	cULus listed (E222847), CE

## Sensed Current Limits

Type	Setpoint (Trip Point) Ranges	Amps		
		Continuous	6 Sec.	1 Sec.
Fixed Core	1-10A	150	400	1000
	10-50A	150	400	1000
Split Core	2-20A	150	400	1000
	20-50A	150	400	1000

# ACUAMP® ACSL Series AC Current Switches

## Dimensions

Inches [mm]

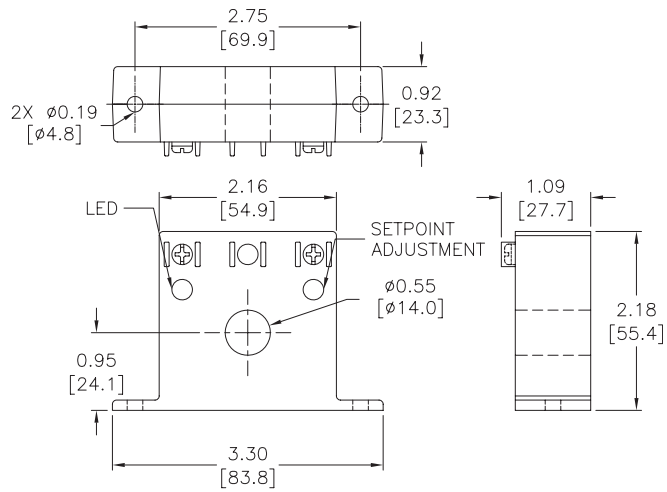

**ACSL Series Fixed Core**

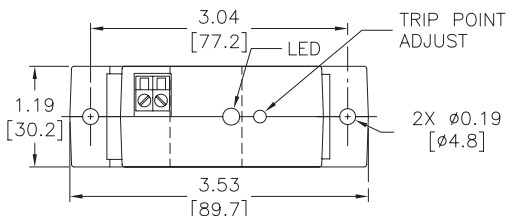

**ACSL Series Split Core**

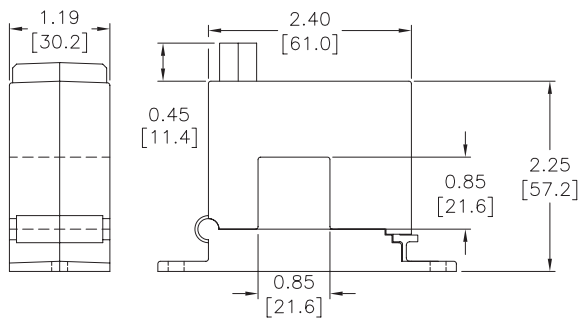

See our website [www.AutomationDirect.com](http://www.AutomationDirect.com) for complete Engineering drawings.

## Wiring

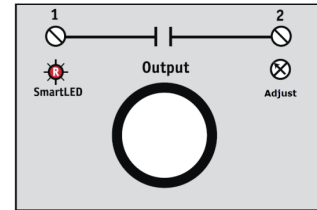
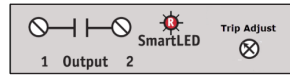

Terminals are #6 screws  
Use 14-22 AWG solid or stranded wire

## Application Example

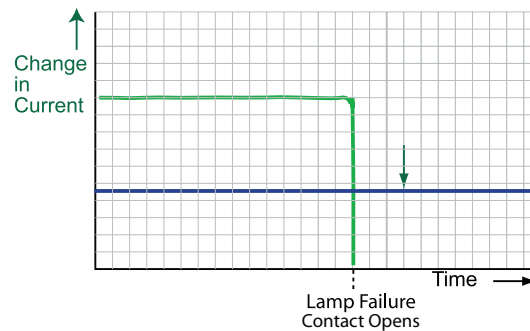
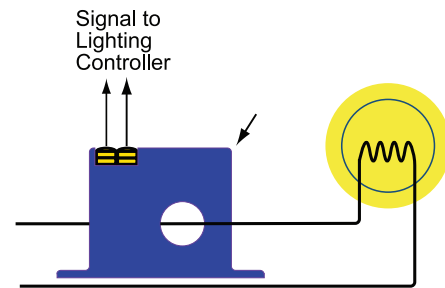



# AC Current Switches, Transducers and Indicators

## Overview

The AcuAMP series of AC current sensors is a family of high-performance current sensors offering outstanding features, flexibility, and durability at an incredible Price. Choose from a wide selection of current transducers, switches and indicators, all designed in a rugged industry-standard feed-through package, including both fixed core and split core models.

AcuAMP current sensors are available with a broad selection of input sensing ranges for maximum flexibility across many current ratings. The current transducer output choices include 4-20 mA, 24VDC loop-powered, and 0 to 10 volt self-powered analog outputs. The Current Switch outputs include isolated solid state switches available in Normally Open and Normally Closed configurations or SPDT relays.

Models with output time delay are also offered in the Current Switch series. The ACL1 Current Indicator senses AC current ranging from 0.5 to 100A and requires no power for the indicating LED.

These current sensors can be mounted in a panel or attached to the monitored conductor with a wire tie. Use the Selection Guide below to find the best sensor for your requirements.

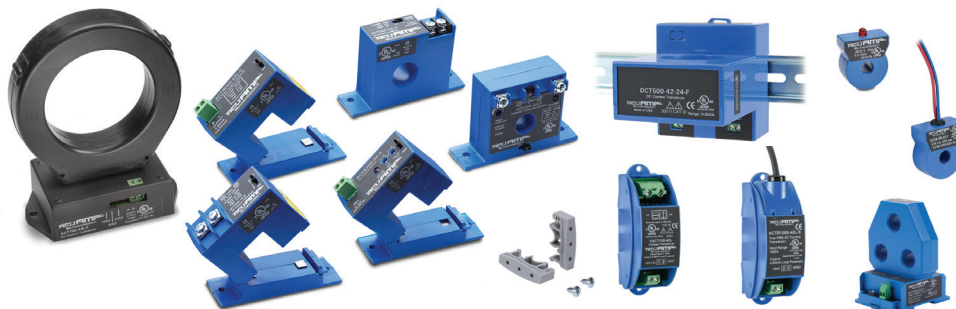

### AcuAMP AC Current Transducer Selection Guide

Specifications	Single-Phase Transducer	Single-Phase Transducer (True RMS)	3-Phase Transducer	3-Phase Transducer (True RMS)
Series	ACT	ACTR	3ACT	3ACTR
<b>Sensing Range</b>	Selectable: ACT005: 0 to 2A 0 to 5A ACT050: 0 to 10A 0 to 20A 0 to 50A ACT200: 0 to 100A 0 to 150A 0 to 200A ACT750: 0 to 375A 0 to 500A 0 to 750A ACT2000: 0 to 1000A 0 to 1333A 0 to 2000A Fixed range: ACT400 0 to 400A ACT600 0 to 600A ACT800 0 to 800A ACT1200 0 to 1200A	Selectable: ACTR005: 0 to 2A 0 to 5A ACTR050: 0 to 10A 0 to 20A 0 to 50A ACTR200: 0 to 100A 0 to 150A 0 to 200A ACTR750: 0 to 375A 0 to 500A 0 to 750A ACTR2000: 0 to 1000A 0 to 1333A 0 to 2000A Fixed range: ACTR400: 0 to 400A ACTR500: 0 to 500A ACTR600: 0 to 600A ACTR800: 0 to 800A ACTR1000: 0 to 1000A ACTR1200: 0 to 1200A ACTR2000: 0 to 2000A	Selectable: 3ACT030: 0 to 10A 0 to 15A 0 to 30A 3ACT100: 0 to 30A 0 to 50A 0 to 100A 3ACT200: 0 to 100A 0 to 150A 0 to 200A	Selectable: 3ACTR030: 0 to 10A 0 to 15A 0 to 30A 3ACTR100: 0 to 30A 0 to 50A 0 to 100A 3ACTR200: 0 to 100A 0 to 150A 0 to 200A
<b>Output</b>	-10 models: 0-10 VDC, self-powered -42L models: 4-20 mA, loop-powered	4-20 mA, loop-powered True RMS	4 -20 mA, loop-powered	4-20 mA, loop-powered True RMS
<b>Frequency Range</b>	-10 models: 50 to 60 Hz -42L models up to 200A: 20 to 100 Hz -42L models 400, 600, 800, 1200A: 50 to 60 Hz sinusoidal waveforms only	20 to 400 Hz; (40 to 400 Hz flexible split core models) sinusoidal and non-sinusoidal waveforms	50 to 60 Hz sinusoidal waveforms only	30 to 100 Hz sinusoidal and non-sinusoidal waveforms
<b>Sensing Aperture</b>	ACT005, ACT050, ACT200: Fixed core: 0.75 in [19mm] dia. Split core: 0.85 in [21.6 mm] sq. ACT750, ACT2000: Fixed core: 3.0 in [76.2 mm] dia. ACT400, ACT600, ACT800: Split core: 2.22 X 1.19 in [56.3 X 30.2 mm] ACT1200 Split core: 3.44 X 2.31 in [87.3 X 58.8 mm]	ACTR005, ACTR050, ACTR200: Fixed core: 0.75 in [19mm] dia. Split core: 0.85 in [21.6 mm] sq. ACTR750, ACTR2000: Fixed core: 3.0 in [76.2 mm] dia. ACTR500, ACTR1000, ACTR2000: Flexible split core: 4.5 in [114.3 mm] dia. ACTR400, ACTR600, ACTR800: Split core: 2.22 X 1.19 in [56.3 X 30.2 mm] ACTR1200 Split core: 3.44 X 2.31 in [87.3 X 58.8 mm]	3x - Fixed core: 0.86 in [21.8 mm] dia.	3x - Fixed core: 0.86 in [21.8 mm] dia.



# AC Current Switches, Transducers and Indicators

AcuAMP AC Current Switch Selection Guide								
Specifications	AC Current Switches							
Series	ACSN100	ACSN250	ACS150	ACSL	ACS200	ACS050/ACS200	ACS035/ACS400	ACSX
<b>Sensing Range</b>	0 to 100A	0 to 250A	Fixed core: 1 to 150A Split core: 1.75 to 150A	0 to 50A	Jumper Selectable:  Fixed core: 1 to 6A 6 to 40A 40 to 175A Split core: 1.75 to 6A 6 to 40A 40 to 200A	1 to 200A	2 to 400A	Jumper Selectable:  Fixed core: 1.5 to 12A 12 to 55A 55 to 175A Split core: 2 to 12A 12 to 55A 55 to 200A
<b>Setpoint (Trip Point)</b>	Non-adjustable: 0.5 A	Non-adjustable: Fixed core: 0.75A Split core: 1.25A	Adjustable: Fixed core: 1-150 A (15-turn potentiometer) Split core: 1.75-150 A (4-turn potentiometer) Monitored load current required to adjust setpoint	Adjustable (3/4-turn potentiometer): ACSL010: 1-10A ACSL020: 2-20A ACSL050: 10-50A Monitored load current not required to adjust setpoint	Adjustable: (4-turn or 15-turn potentiometer) Fixed core: 1-175A Split core: 1.75-200A Monitored load current required to adjust setpoint	Adjustable: (Single turn potentiometer): ACS050: 1-50A ACS200: 4-200A	Adjustable: (3/4-turn potentiometer): ACS035: 2-35A ACS400: 25-400A	Adjustable: Fixed core: 1.5-175A (15-turn potentiometer) Split core: 2-200A (4-turn potentiometer) Monitored load current required to adjust setpoint
<b>Output</b>	Isolated solid state:  Normally Open 0.15 A @ 120VAC or VDC	Isolated solid state:  Normally Open 0.15 A @ 240VAC or VDC	Isolated solid state:  Normally Open 0.15 A @ 240VAC or VDC  Normally Closed 0.2 A @ 135VAC or VDC	Isolated solid state:  Normally Open AC: 0.15 A @ 240VAC	Isolated solid state:  Normally Open or Normally Closed AC model: 1A @ 240VAC  Normally Open AC model: 3A @ 120VAC  Normally Open or Normally Closed DC model: 0.15 A @ 30VDC	Isolated solid state:  Normally Open 1A @ 240VAC	Two Independent Single Pole, Double Throw electro-mechanical relays AC: 1A @ 120VAC DC: 2A @ 30VDC	Isolated solid state:  Normally Open or Normally Closed AC model: 1A @ 240VAC  Normally Open AC/DC model: 0.15 A @ 240 VAC/ VDC  Normally Closed AC/DC model: 0.2 A @ 135 VAC/ VDC
<b>Frequency Range</b>	50 to 400 Hz	6 to 100 Hz	6 to 100 Hz	10 to 100 Hz	6 to 100 Hz	40 to 100 Hz	40 to 65 Hz	50 to 100 Hz
<b>Response Time</b>	N/A	120ms	120ms	100ms & 2s inrush delay	40 to 250 ms	0.50 sec. 5% over set point 0.20 sec. 50% over set point 0.15 sec. 100% over set point	40 - 120ms	Field adjustable time delay: 0.12 to 15 seconds
<b>Sensing Aperture</b>	0.30 in [8.13 mm] dia.	Fixed core: 0.75 in [19mm] dia. Split core: 0.85 in [21.7 mm] sq.	Fixed core: 0.75 in [19mm] dia. Split core: 0.85 in [21.7 mm] sq.	Fixed core: 0.55 in [13.97 mm] dia. Split core: 0.85 in [21.7 mm] sq.	Fixed core: 0.55 in [13.97 mm] dia. Split core: 0.85 in [21.7 mm] sq.	0.75 in [19mm] dia.	1.31 in [33.3 mm] dia.	Fixed core: 0.75 in [19mm] dia. Split core: 0.85 in [21.7 mm] sq.



# AC Current Switches, Transducers and Indicators

AcuAMP AC Current Transducer/Switch and Indicator Selection Guide			
Specifications	AC Current Transducer	AC Current Transducer/Switch	Indicator
Series	ACTH	ACTS	ACL1
Sensing Range	0 to 50A	1 to 200A	0 to 100A
Setpoint (Trip Point)	Not Applicable	Adjustable: (Single turn potentiometer): ACTS050: 1-50A ACTS200: 4-200A	Non-adjustable: 0.5 A
Output	4 -20 mA, loop-powered adaptive True RMS	4-20mA analog output and isolated solid state: Normally Open 1A @ 240VAC	LED Only (flashing, red)
Frequency Range	40 to 400 Hz	40 to 400 Hz	50 to 400 Hz
Response Time	400ms at 100% duty cycle, or duty cycle period plus 40ms	Switch: 0.50 sec. 5% over set point 0.20 sec. 50% over set point 0.15 sec. 100% over set point Analog: < 0.30 sec. 90% step change < 0.40 sec. 100% step change	N/A
Sensing Aperture	0.86 in [21.9 mm] sq.	0.75 in [19mm] dia.	0.30 in [7.6 mm] dia.



Click on the thumbnail or go to <https://www.automationdirect.com/VID-CT-0001> for a short introductory video on the AcuAmp Current Switches, Transducers and Indicators



# AC Current Sensors, Switches and Transducers Application Guide

## Application Guide

ACUAMP current sensors are a great fit for many applications including material handling, fan and pump applications, and heating systems. With current transducers, current switches and current indicators, this sensor family gives you

valuable data for processes ranging from monitoring loads to preventive maintenance. Models with the ability to read True RMS non-sinusoidal waveforms make it easy to monitor applications using variable frequency drives.

Use the application examples to help choose the best sensor model for your application.

### Pump Jam & Suction Loss Protection

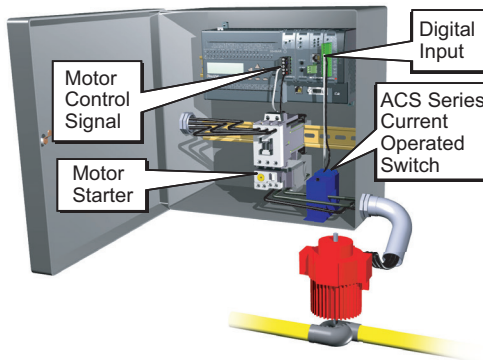

### Heater Life Prediction

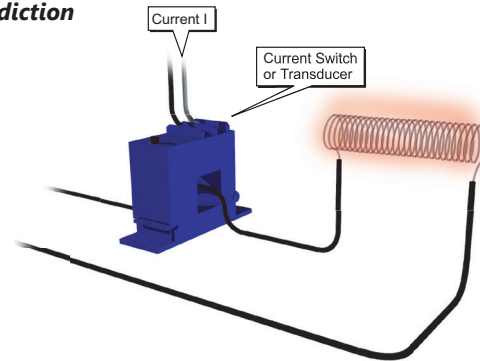

### Crusher/Grinder/Shredder Motor Interlocks

The performance of size reduction equipment like crushers or grinders can be optimized by controlling the in-feed in order to:

- Help prevent jamming
- Improve the uniformity of the resultant product
- Enhance overall production efficiency

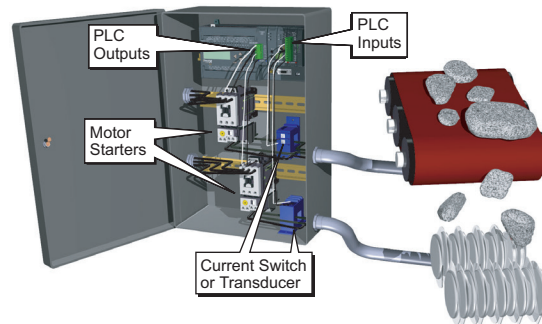

### Pump Load Monitoring

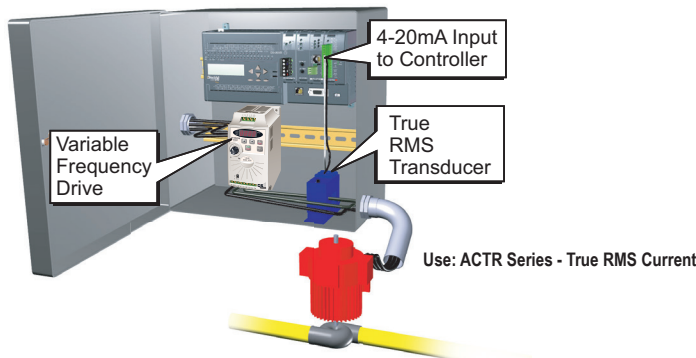

### Lamp Failure Detection

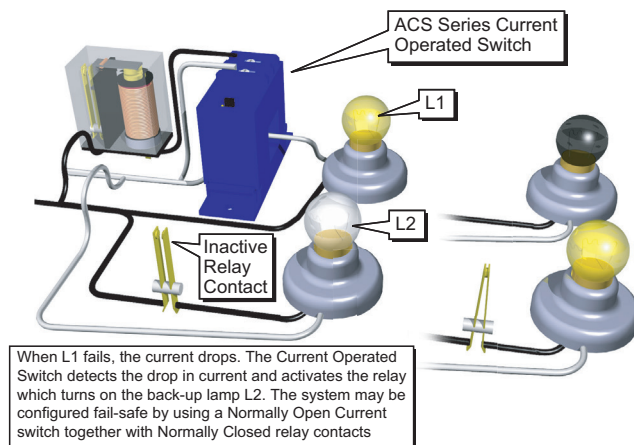

### Electric Motor Load Status

