

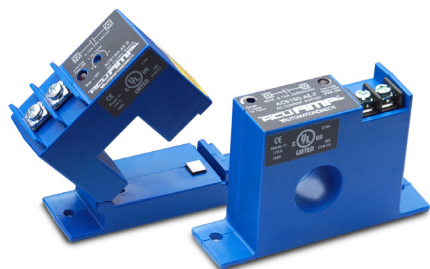

ACS150 Series AC Current Switches



ACS150 Series current operated switches combine a current transformer, signal conditioner and limit alarm into a single package for use in monitoring or proof of operation applications. Offering an adjustable setpoint range of 1 to 150 amps and universal, solid-state outputs, the self-powered ACS150 can be tailored to provide accurate and dependable digital indication of over-current conditions across a broad range of applications. The ACS150 is available in fixed-core and split-core models.

Applications

Electronic Proof of Flow

- Current operated switch eliminates the need for multiple pipe or duct penetrations.
- More reliable than electromechanical pressure or flow switches.

Conveyors

- Detect jams and overloads; useful when interlocking multiple conveyor sections

Heating Circuits

- Detect ON/OFF status; faster response times than with temperature sensors.

Loss of Load Detective

- Detect belt or coupling breaks with fast response times

Lighting Circuits

- Easier and faster than photocells

Features

- Choose from:
N.O. 0.15 A @ 240VAC or VDC or
N.C. 0.20 A @ 135VAC or VDC output options.
- Status LED provides visual indication of setpoint trip and contact action.
- Self-powered operation cuts installation time and operating costs.
- Potentiometer-adjustable trip points speed start-up and allow for tailored operation.
- Choose either split core or fixed core enclosure style. Split core packages allow easy installation on existing systems ; fixed core enclosures offer more compact package for OEM or new installations.
- Built-in mounting feet with optional 35mm DIN rail adapter available.
- Five-year warranty



ACS150 AC Current Operated Switches				
Part Number	Description	Pcs/Pkg	Wt (lb)	Price
ACS150-AE-F	AcuAMP AC current switch, fixed core, 1-150A sensing range, 1-150A adjustable trip point, 15-turn potentiometer, solid state switch. N.O. output. 0.15A @ 240 VAC/VDC output rating.	1	0.30	\$86.00
ACS150-AE-S	AcuAMP AC current switch, split core, 1.75-150A sensing range, 1.75-150A adjustable trip point, 4-turn potentiometer, solid state switch. N.O. output. 0.15A @ 240 VAC/VDC output rating.	1	0.35	\$106.00
ACS150-CE-F	AcuAMP AC current switch, fixed core, 1-150A sensing range, 1-150A adjustable trip point, 15-turn potentiometer, solid state switch. N.C. output. 0.2A @ 135 VAC/VDC output rating.	1	0.30	\$86.00
ACS150-CE-S	AcuAMP AC current switch, split core, 1.75-150A sensing range, 1.75-150A adjustable trip point, 4-turn potentiometer, solid state switch. N.C. output. 0.2A @ 135 VAC/VDC output rating.	1	0.35	\$106.00
Accessories				
DRA-2B	35mm DIN rail adapters, 1.70"x0.45"x0.83" [43.7x11.4x21.0 mm]	2	0.40	\$6.00

ACS150 Sensed Current Limits				
Type	Input Range	Amps		
		Continuous	6 Sec. max	1 Sec. max
Fixed Core	1 to 150A	150	400	1000
Split Core	1.75 to 150A	150	400	1000

ACS150 Series Specifications	
Power Supply	None - Self-powered
Output	Isolated solid-state switch
Output Rating	N.O. 0.15 A @ 240VAC or VDC N.C. 0.20 A @ 135VAC or VDC
Response Time	120ms
Off State Leakage	<10µA
Setpoint (Trip Point)	Fixed core: 1 to 150A. Split core: 1.75 to 150A
Hysteresis	5% of Setpoint
Setpoint (Trip Point) Adjust	Fixed core: 15-turn potentiometer.; Split core: 4-turn potentiometer
Isolation Voltage	UL listed to 1,270VAC. Tested to 5,000VAC (1 minute max)
Frequency Range	6 to 100 Hz
Case	UL 94V-0 flammability rated
Environmental	Operating Temperature: -58 to 149°F [-50 to 65°C]
	Relative Humidity: 0-95% RH, Non-condensing
	Pollution Degree 2
Certifications	Altitude to 2000 meters cULus listed (E222847), CE



ACS150 Series AC Current Switches

Dimensions

Inches [mm]

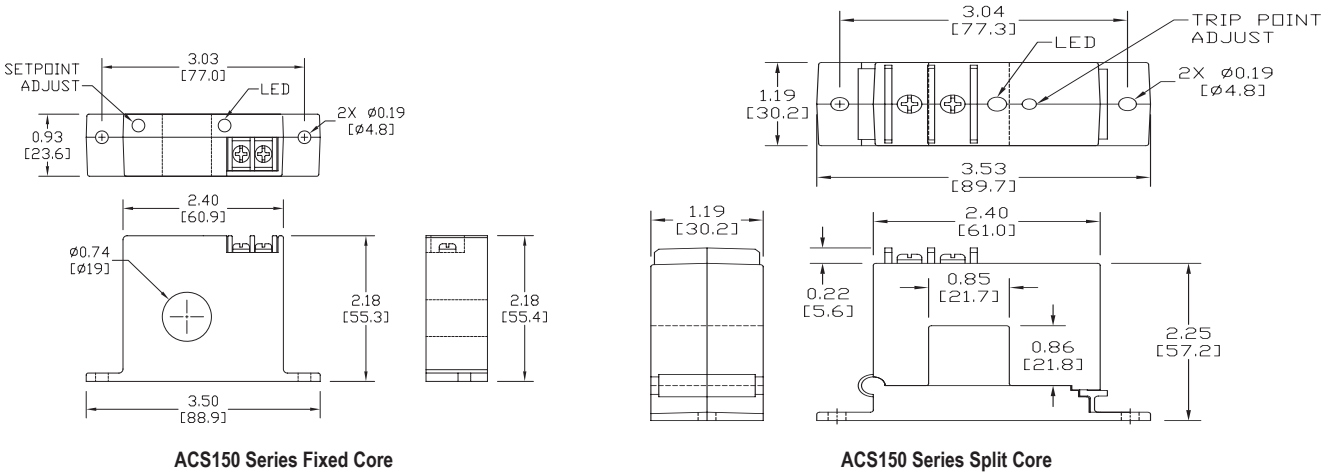

See our website www.AutomationDirect.com for complete Engineering drawings.

Wiring

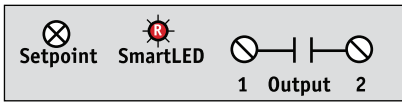

Terminals are #6 screws
Use up to 14 AWG copper wire

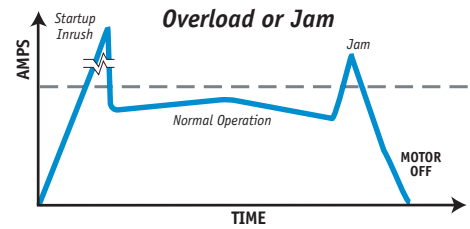
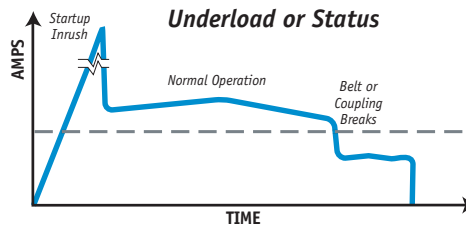

Application Example

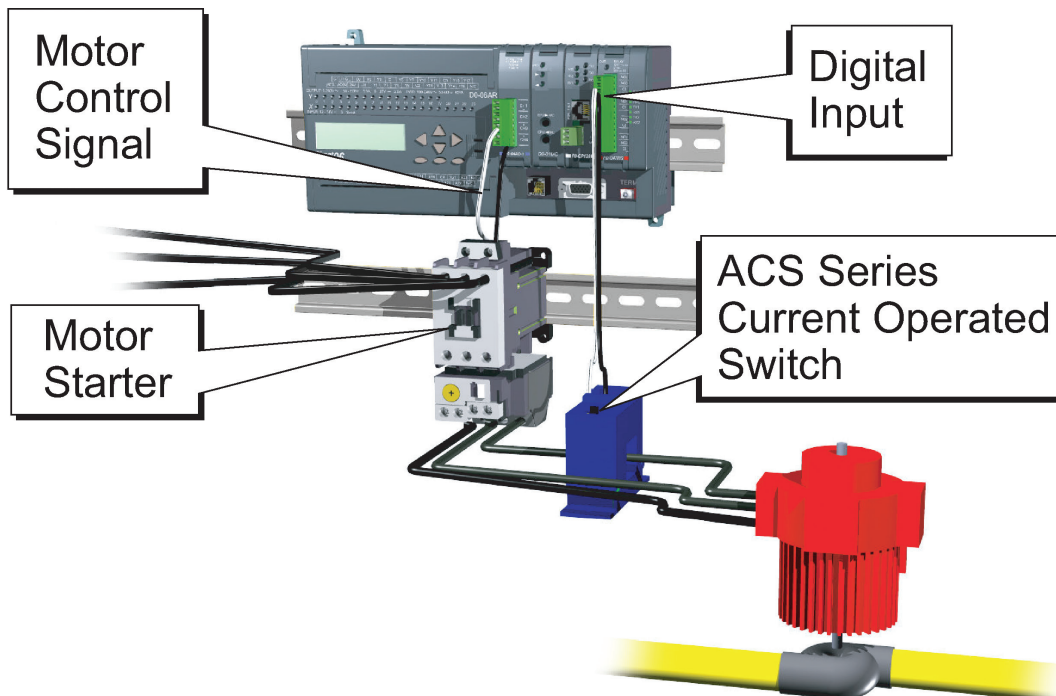



AC Current Switches, Transducers and Indicators

Overview

The AcuAMP series of AC current sensors is a family of high-performance current sensors offering outstanding features, flexibility, and durability at an incredible Price. Choose from a wide selection of current transducers, switches and indicators, all designed in a rugged industry-standard feed-through package, including both fixed core and split core models.

AcuAMP current sensors are available with a broad selection of input sensing ranges for maximum flexibility across many current ratings. The current transducer output choices include 4-20 mA, 24VDC loop-powered, and 0 to 10 volt self-powered analog outputs. The Current Switch outputs include isolated solid state switches available in Normally Open and Normally Closed configurations or SPDT relays.

Models with output time delay are also offered in the Current Switch series. The ACL1 Current Indicator senses AC current ranging from 0.5 to 100A and requires no power for the indicating LED.

These current sensors can be mounted in a panel or attached to the monitored conductor with a wire tie. Use the Selection Guide below to find the best sensor for your requirements.



AcuAMP AC Current Transducer Selection Guide				
Specifications	Single-Phase Transducer	Single-Phase Transducer (True RMS)	3-Phase Transducer	3-Phase Transducer (True RMS)
Series	ACT	ACTR	3ACT	3ACTR
Sensing Range	Selectable: ACT005: 0 to 2A 0 to 5A ACT050: 0 to 10A 0 to 20A 0 to 50A ACT200: 0 to 100A 0 to 150A 0 to 200A ACT750: 0 to 375A 0 to 500A 0 to 750A ACT2000: 0 to 1000A 0 to 1333A 0 to 2000A Fixed range: ACT400 0 to 400A ACT600 0 to 600A ACT800 0 to 800A ACT1200 0 to 1200A	Selectable: ACTR005: 0 to 2A 0 to 5A ACTR050: 0 to 10A 0 to 20A 0 to 50A ACTR200: 0 to 100A 0 to 150A 0 to 200A ACTR750: 0 to 375A 0 to 500A 0 to 750A ACTR2000: 0 to 1000A 0 to 1333A 0 to 2000A Fixed range: ACTR400: 0 to 400A ACTR500: 0 to 500A ACTR600: 0 to 600A ACTR800: 0 to 800A ACTR1000: 0 to 1000A ACTR1200: 0 to 1200A ACTR2000: 0 to 2000A	Selectable: 3ACT030: 0 to 10A 0 to 15A 0 to 30A 3ACT100: 0 to 30A 0 to 50A 0 to 100A 3ACT200: 0 to 100A 0 to 150A 0 to 200A	Selectable: 3ACTR030: 0 to 10A 0 to 15A 0 to 30A 3ACTR100: 0 to 30A 0 to 50A 0 to 100A 3ACTR200: 0 to 100A 0 to 150A 0 to 200A
Output	-10 models: 0-10 VDC, self-powered -42L models: 4-20 mA, loop-powered	4-20 mA, loop-powered True RMS	4 -20 mA, loop-powered	4-20 mA, loop-powered True RMS
Frequency Range	-10 models: 50 to 60 Hz -42L models up to 200A: 20 to 100 Hz -42L models 400, 600, 800, 1200A: 50 to 60 Hz sinusoidal waveforms only	20 to 400 Hz; (40 to 400 Hz flexible split core models) sinusoidal and non-sinusoidal waveforms	50 to 60 Hz sinusoidal waveforms only	30 to 100 Hz sinusoidal and non-sinusoidal waveforms
Sensing Aperture	ACT005, ACT050, ACT200: Fixed core: 0.75 in [19mm] dia. Split core: 0.85 in [21.6 mm] sq. ACT750, ACT2000: Fixed core: 3.0 in [76.2 mm] dia. ACT400, ACT600, ACT800: Split core: 2.22 X 1.19 in [56.3 X 30.2 mm] ACT1200 Split core: 3.44 X 2.31 in [87.3 X 58.8 mm]	ACTR005, ACTR050, ACTR200: Fixed core: 0.75 in [19mm] dia. Split core: 0.85 in [21.6 mm] sq. ACTR750, ACTR2000: Fixed core: 3.0 in [76.2 mm] dia. ACTR500, ACTR1000, ACTR2000: Flexible split core: 4.5 in [114.3 mm] dia. ACTR400, ACTR600, ACTR800: Split core: 2.22 X 1.19 in [56.3 X 30.2 mm] ACTR1200 Split core: 3.44 X 2.31 in [87.3 X 58.8 mm]	3x - Fixed core: 0.86 in [21.8 mm] dia.	3x - Fixed core: 0.86 in [21.8 mm] dia.



AC Current Switches, Transducers and Indicators

AcuAMP AC Current Switch Selection Guide								
Specifications	AC Current Switches							
Series	ACSN100	ACSN250	ACS150	ACSL	ACS200	ACS050/ACS200	ACS035/ACS400	ACSX
Sensing Range	0 to 100A	0 to 250A	Fixed core: 1 to 150A Split core: 1.75 to 150A	0 to 50A	Jumper Selectable: Fixed core: 1 to 6A 6 to 40A 40 to 175A Split core: 1.75 to 6A 6 to 40A 40 to 200A	1 to 200A	2 to 400A	Jumper Selectable: Fixed core: 1.5 to 12A 12 to 55A 55 to 175A Split core: 2 to 12A 12 to 55A 55 to 200A
Setpoint (Trip Point)	Non-adjustable: 0.5 A	Non-adjustable: Fixed core: 0.75A Split core: 1.25A	Adjustable: Fixed core: 1-150 A (15-turn potentiometer) Split core: 1.75-150 A (4-turn potentiometer) Monitored load current required to adjust setpoint	Adjustable (3/4-turn potentiometer): ACSL010: 1-10A ACSL020: 2-20A ACSL050: 10-50A Monitored load current not required to adjust setpoint	Adjustable: (4-turn or 15-turn potentiometer) Fixed core: 1-175A Split core: 1.75-200A Monitored load current required to adjust setpoint	Adjustable: (Single turn potentiometer): ACS050: 1-50A ACS200: 4-200A	Adjustable: (3/4-turn potentiometer): ACS035: 2-35A ACS400: 25-400A	Adjustable: Fixed core: 1.5-175A (15-turn potentiometer) Split core: 2-200A (4-turn potentiometer) Monitored load current required to adjust setpoint
Output	Isolated solid state: Normally Open 0.15 A @ 120VAC or VDC	Isolated solid state: Normally Open 0.15 A @ 240VAC or VDC	Isolated solid state: Normally Open 0.15 A @ 240VAC or VDC Normally Closed 0.2 A @ 135VAC or VDC	Isolated solid state: Normally Open AC: 0.15 A @ 240VAC	Isolated solid state: Normally Open or Normally Closed AC model: 1A @ 240VAC Normally Open AC model: 3A @ 120VAC Normally Open or Normally Closed DC model: 0.15 A @ 30VDC	Isolated solid state: Normally Open 1A @ 240VAC	Two Independent Single Pole, Double Throw electro-mechanical relays AC: 1A @ 120VAC DC: 2A @ 30VDC	Isolated solid state: Normally Open or Normally Closed AC model: 1A @ 240VAC Normally Open AC/DC model: 0.15 A @ 240 VAC/ VDC Normally Closed AC/DC model: 0.2 A @ 135 VAC/ VDC
Frequency Range	50 to 400 Hz	6 to 100 Hz	6 to 100 Hz	10 to 100 Hz	6 to 100 Hz	40 to 100 Hz	40 to 65 Hz	50 to 100 Hz
Response Time	N/A	120ms	120ms	100ms & 2s inrush delay	40 to 250 ms	0.50 sec. 5% over set point 0.20 sec. 50% over set point 0.15 sec. 100% over set point	40 - 120ms	Field adjustable time delay: 0.12 to 15 seconds
Sensing Aperture	0.30 in [8.13 mm] dia.	Fixed core: 0.75 in [19mm] dia. Split core: 0.85 in [21.7 mm] sq.	Fixed core: 0.75 in [19mm] dia. Split core: 0.85 in [21.7 mm] sq.	Fixed core: 0.55 in [13.97 mm] dia. Split core: 0.85 in [21.7 mm] sq.	Fixed core: 0.55 in [13.97 mm] dia. Split core: 0.85 in [21.7 mm] sq.	0.75 in [19mm] dia.	1.31 in [33.3 mm] dia.	Fixed core: 0.75 in [19mm] dia. Split core: 0.85 in [21.7 mm] sq.



AC Current Switches, Transducers and Indicators

AcuAMP AC Current Transducer/Switch and Indicator Selection Guide			
Specifications	AC Current Transducer	AC Current Transducer/Switch	Indicator
Series	ACTH	ACTS	ACL1
Sensing Range	0 to 50A	1 to 200A	0 to 100A
Setpoint (Trip Point)	Not Applicable	Adjustable: (Single turn potentiometer): ACTS050: 1-50A ACTS200: 4-200A	Non-adjustable: 0.5 A
Output	4 -20 mA, loop-powered adaptive True RMS	4-20mA analog output and isolated solid state: Normally Open 1A @ 240VAC	LED Only (flashing, red)
Frequency Range	40 to 400 Hz	40 to 400 Hz	50 to 400 Hz
Response Time	400ms at 100% duty cycle, or duty cycle period plus 40ms	Switch: 0.50 sec. 5% over set point 0.20 sec. 50% over set point 0.15 sec. 100% over set point Analog: < 0.30 sec. 90% step change < 0.40 sec. 100% step change	N/A
Sensing Aperture	0.86 in [21.9 mm] sq.	0.75 in [19mm] dia.	0.30 in [7.6 mm] dia.



Click on the thumbnail or go to <https://www.automationdirect.com/VID-CT-0001> for a short introductory video on the AcuAmp Current Switches, Transducers and Indicators



AC Current Sensors, Switches and Transducers Application Guide

Application Guide

ACUAMP current sensors are a great fit for many applications including material handling, fan and pump applications, and heating systems. With current transducers, current switches and current indicators, this sensor family gives you

valuable data for processes ranging from monitoring loads to preventive maintenance. Models with the ability to read True RMS non-sinusoidal waveforms make it easy to monitor applications using variable frequency drives.

Use the application examples to help choose the best sensor model for your application.

Pump Jam & Suction Loss Protection

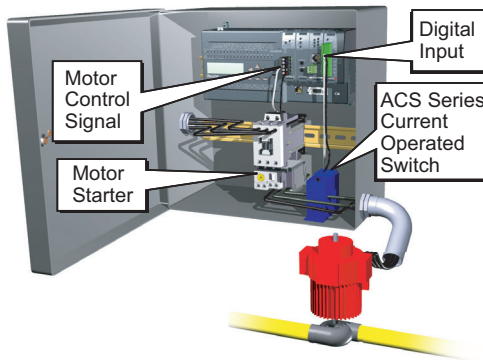

Heater Life Prediction

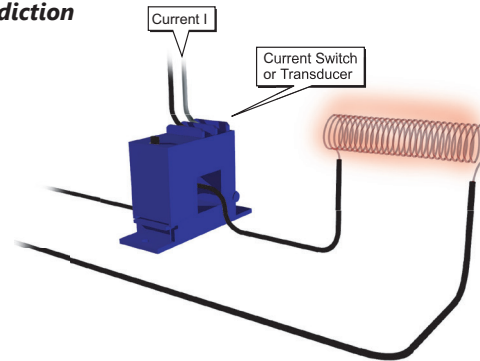

Crusher/Grinder/Shredder Motor Interlocks

The performance of size reduction equipment like crushers or grinders can be optimized by controlling the in-feed in order to:

- Help prevent jamming
- Improve the uniformity of the resultant product
- Enhance overall production efficiency

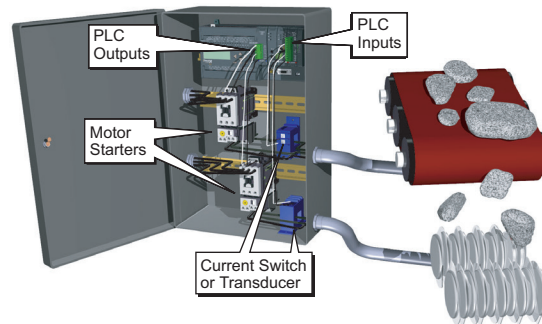

Pump Load Monitoring

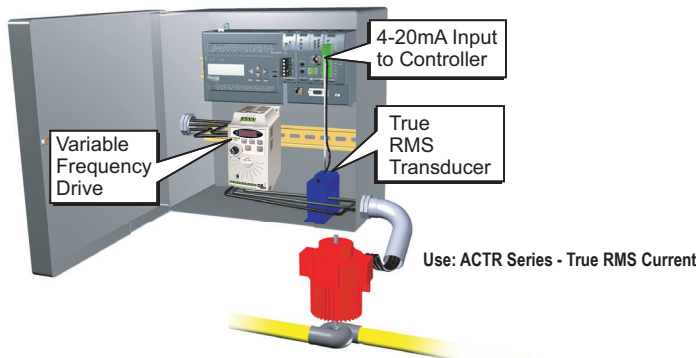

Lamp Failure Detection

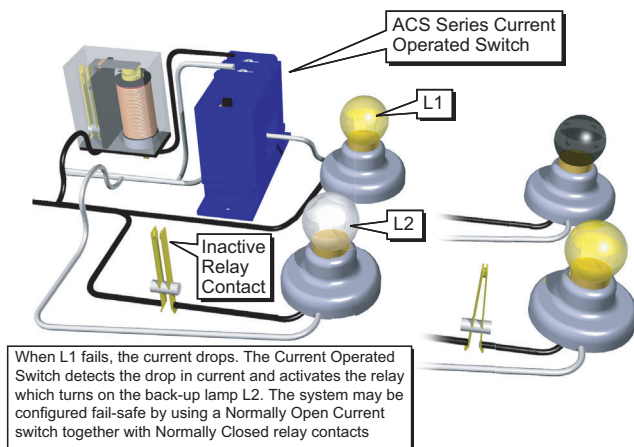

Electric Motor Load Status

