

TOSVERT VF-MB1 / S15

EtherCAT[®] option unit Function Manual

IPE003Z

Toshiba Industrial Products and Systems Corporation**NOTICE**

1. Read this manual before installing or operating. Keep this instruction manual on hand of the end user, and make use of this manual in maintenance and inspection.
2. All information contained in this manual will be changed without notice. Please contact your Toshiba distributor to confirm the latest information.

Safety precautions

On the inverter and in its instruction manual, important information is contained for preventing injuries to users and damages to assets and for proper use of the device. Read the instruction manual attached to inverter along with this instruction manual for completely understanding the safety precautions and adhere to the contents of these manuals.



This option needs the option adaptor to connect VF-S15 which type form is SBP009Z. Please match here and buy it when SBP009Z is not at hand yet.

After reading this function manual, please keep it handy for future reference. For details of its general handling, see an instruction manual attached with the option unit.

- TOSVERT VF-MB1 Instruction Manual E6581697
- TOSVERT VF-S15 Instruction Manual E6581611
- TOSVERT VF-AS3 Instruction Manual..... E6582062
- TOSVERT VF-MB1/S15/AS3 communication option Precautions Manual ... E6582163
- VF-S15 Option Adapter Instruction Manual E6581838

The items described in the instruction manual and on the inverter itself are very important so that you can use safely the inverter, prevent injury to yourself and other people around you as well as to prevent damage to property in the area. Thoroughly familiarize yourself with the symbols and indications shown below and then continue to read the manual. Make sure that you observe all warnings given.



Description of display



Display	Meaning
 Warning	Indicates that "improper use may result in death or serious injury."
 Caution	Indicates that "improper use may result in injury or only property damage." ^{*1*2}



*1: Injury means injury, burn, electric shock, etc. that do not require hospitalization or long-term hospital visits for treatment.

*2: Property damage means extended damage related to damage to the properties and materials.

Meaning of symbols

Display	Meaning
 Mark	Indicates prohibition (matters prohibited). The concrete contents are indicated inside or near the symbol with a picture or text.
 Mark	Indicates instructions (matters to be observed without fail). The concrete contents are indicated inside or near the symbol with a picture or text.

 Warning	
 Mandatory	<ul style="list-style-type: none"> ▼ Shut off power when installing and wiring this option. Wait at least 15 minutes and check to make sure that the charge lamp is no longer lit. If steps above are not properly performed, this can result in electric shock or product failure. ▼ Use an emergency stop device and an additional safety device in your system to prevent serious accident due to the option malfunctions. Usage without any emergency stop device or any additional safety device can result in accident or injury. ▼ Use an additional safety device with your system to prevent a serious accident due to the network malfunctions. Usage without an additional safety device may cause an accident. ▼ Make sure that the operation signals are STOP before resetting drive's fault. The motor may suddenly start and that may result in injuries. ▼ Do not pull on any cable itself. Doing so could result in damage or malfunction.

 Caution	
 Prohibited	<ul style="list-style-type: none"> ▼ Do not connect to any communication device other than the one supported. It may cause an accident. ▼ Do not touch the sharp edges of the inverter or option. Doing so could result in injury. ▼ Do not use application of writing into inverter parameters more than 100,000 times. The Life of EEPROM is approximately 100,000 times. Frequent writing to the EEPROM of inverter will cause a memory corruption.
 Mandatory	<ul style="list-style-type: none"> ▼ Insert an electromagnetic contactor between the inverter and the power supply so that the machine can be stopped without fail from an external controller in case of an emergency. ▼ Set up "Communication error trip function (see below)" to stop the Inverter when the option unit is deactivated by an unusual event such as tripping, an operating error, power outage, failure, etc. <ul style="list-style-type: none"> - Network Time-Out, Inverter operation at disconnection, Preset speed operation selection (Refer to "5.3.1 Network error detection (E 100 - E 103)" for details) Deactivated the option module may cause an accident, if the "Communication error trip function" is not properly set up.

Notes on use

Notes	
	<ul style="list-style-type: none"> ▼ Please install away from the place where temperature and humidity change rapidly. ▼ Keep a distance of 20cm or more between the drive 's power cable and the data transmission cable. Or the drive might malfunction because of noise. ▼ If the control power is turned off due to momentary power failure etc., communication can not be performed temporarily.

Table of Contents

1. PRODUCT VERSION AND ESI FILE	5
2. OVERVIEW	6
2.1. Specification	6
3. NAMES AND FUNCTIONS	8
3.1. Outline	8
3.2. RJ45 connector pin layout	9
3.3. Status indicator	10
3.3.1. LED on the option	10
3.3.2. Labels on the inverter (Only for the VF-AS3)	11
4. HARDWARE SETUP	13
4.1. Mounting and removing	13
4.1.1. Mounting and removing of option for VF-MB1	13
4.1.2. Mounting and removing of option for VF-S15	13
4.1.3. Mounting and removing of option for VF-AS3	13
5. PARAMETERS	14
5.1. Communication parameters	14
5.2. Communication parameters for IPE003Z	15
5.3. The details of the parameter setting	18
5.3.1. Network error detection ($\text{C } 100 - \text{C } 103$)	18
6. COMMUNICATION OBJECT	19
6.1. Communication Profile	19
6.1.1. RPDO: Receive PDO	20
6.1.2. TPDO: Transmit PDO	21
6.2. TOSHIBA drive profile	22
6.3. Application Profile (CiA402)	23
6.4. Abort code (CiA 301)	24
7. RUNNING BY TOSHIBA DRIVE PROFILE	25
7.1. TOSHIBA Drive profile	25
7.1.1. <i>FA06</i> : 0x2A06 (Communication command1)	28
7.1.2. <i>FA23</i> : 0x2A23 (Communication command 2)	30
7.1.3. <i>FA07</i> : 0x2A07 (Frequency reference from internal option)	32
7.1.4. <i>FA33</i> : 0x2A33 (Torque command) (Only for the VF-AS3)	32
7.1.5. <i>FA50</i> : 0x2A50 (Terminal output data from communication)	32
7.1.6. <i>FA51</i> : 0x2A51 (Analog output (FM) data from communication)	33
7.1.7. <i>FA52</i> : 0x2A52 (Terminal AM output data) (Only for the VF-AS3)	33
7.1.8. <i>F441</i> : 0x2441 (Power running torque limit level 1) (Only for the VF-AS3)	33
7.1.9. <i>F443</i> : 0x2443 (Regenerative torque limit level 1) (Only for the VF-AS3)	33
7.1.10. <i>F460</i> : 0x2460 (Speed control response 1) (Only for the VF-AS3)	33
7.1.11. <i>F461</i> : 0x2461 (Speed control stabilization coefficient 1) (Only for the VF-AS3)	33
7.1.12. <i>Fd01</i> : 0x2D01 (Inverter operating status 1 (real time))	34
7.1.13. <i>Fd00</i> : 0x2D00 (Output frequency (real time))	36
7.1.14. <i>Fd03</i> : 0x2D03 (Output current (real time))	36
7.1.15. <i>FE35</i> : 0x2E35, <i>FE36</i> : 0x2E36, <i>FE37</i> : 0x2E37 (Monitoring of the analog input)	37
7.1.16. <i>FE14</i> : 0x2E14 (Cumulative run time)	37
7.1.17. <i>FE40</i> : 0x2E40 (Analog output (FM))	37
7.1.18. <i>FE41</i> : 0x2E41 (AM output monitor) (Only for the VF-AS3)	37
7.1.19. <i>FC91</i> : 0x2C91 (Alarm code)	38
7.1.20. <i>Fd06</i> : 0x2D06 (Input TB Status)	39
7.1.21. <i>Fd07</i> : 0x2D07 (Output TB Status)	40
8. RUNNING BY CIA402 DRIVE PROFILE	41
8.1. CiA 402 drive profile	41
8.1.1. Object 0x6040: Controlword	42
8.1.2. Object 6041: Statusword	42
8.1.3. CiA402 State Chart	44
8.1.4. Information of CiA402 State	45
8.1.5. Object 0x6042: vl_target_velocity	47
8.1.6. Object 0x6043: vl_velocity_demand	47

8.1.7.	Object 0x6044: vl_velocity_actual_value	47
8.1.8.	Object 0x6046: vl_velocity_min_max_amount.....	47
8.1.9.	Object 0x6048: vl_velocity_acceleration	48
8.1.10.	Object 0x6049: vl_velocity_deceleration	48
8.1.11.	Object 0x604A: vl_velocity_quick_stop	48
8.1.12.	Object 0x605A: Quick stop option code	49
8.1.13.	Object 0x6060: Mode of operation	50
8.1.14.	Object 0x6061: Mode of operation display	50
8.1.15.	Object 0x6502: Supported drive mode.....	50
8.1.16.	Object 603F: Error Code	51
9.	ETHERCAT STATE MACHINE (ESM)	53
10.	EXAMPLE:VF-MB1 WITH TWINCAT® “PLC-CONFIGURATION”	55
10.1.	Hardware	55
10.2.	TwinCAT® software installation.....	55
10.3.	ESI file (EtherCAT Slave Information)	55
10.4.	VF-MB1 configuration	55
10.5.	System Manager: Declare your computer on Ethernet network	56
10.6.	System Manager: Install the master	57
10.7.	System Manager – Install the slave: MB1 in “PLC- configuration”	59
10.8.	PLC – Control: initialization.....	60
10.9.	PLC – Control: Declare the variables	61
10.10.	System Manager – Append PLC Project	62
10.11.	PLC - Control: new compilation	64
10.12.	System Manager: Activate configuration	64
10.13.	PLC - Control: Run	64
10.14.	PLC - Control: start and stop the motor	64
10.15.	PLC - Control: add a library for other services.....	65
10.16.	Method of add the PDOs	66

1. Product version and ESI file

It shows the differences by product version below.

Item	Suffix of the TYPE-FORM *2	Applicable model	ESI file *1
IPE003Z Product version	None	VF-MB1	TOSVERT_VFMB1.xml
		VF-S15	TOSVERT_VFS15.xml
	“-1”	VF-MB1	TOSVERT_VFMB1_1.xml
		VF-S15	TOSVERT_VFS15_1.xml
		VF-AS3 (CPU1 version 106 or more)	TOSVERT_VFAS3_1.xml

*1: Regarding ESI (EtherCAT Slave Information) file in XML format for VF-MB1/S15/AS3,
Please contact your Toshiba distributor.

*2: Suffix can be checked by the labels on the product and the package.

Name label

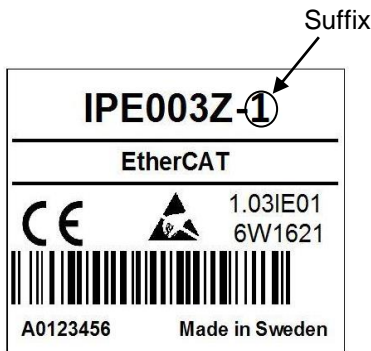

Package label

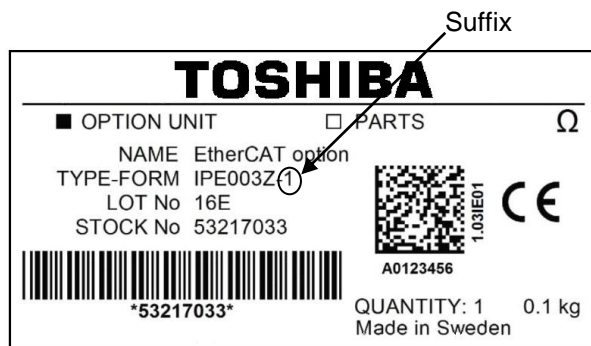

2. Overview

The EtherCAT® interface (IPE003Z) allows the VF-MB1/S15/AS3 drive to be connected into the EtherCAT® network. The drive is controlled by 2 drive profiles (CiA402 V3 or TOSHIBA). Also, VF-MB1/S15/AS3 supports BECKHOFF software TwinCAT® V2.x with CODESYS V2.

EtherCAT® and TwinCAT® are registered trademark and patented technology, licensed by Beckhoff Automation GmbH, Germany.



2.1. Specification

Module specifications

Item	Specification
Type-form	IPE003Z
Applicable inverter	VF-MB1 VF-S15 with SBP009Z VF-AS3 (CPU1 version 106 or more)
Connector	RJ45 × 2
Supported network	EtherCAT® Supports the CoE only. Supports CANopen CiA® 402 V3 drive profile
Indicator	4 LEDs indicating the communication status and error status and 2 link status
Protection degree	IP20
Environments	Correspond to inverter. Note) The maximum ambient temperature for VF-AS3 is 50 degrees when the option is installed.

Network specifications

Item	Specification	
EtherCAT	Baud rate	100Mbps
	Cyclic communication	PDO function *2
	Acyclic communication	SDO function *3
	Drive profile	CiA402 drive profile
		TOSHIBA drive profile
	Other support service	EtherCAT state machine Emergency (EMCY)
Command reception time	About 5ms *1	

*1: Command reception time is the time until the inverter is operated by RUN command on the cyclic communication.

***2: Cyclical Communication: PDO**

- PDO is intended for use with the communication scanner according to CiA402.
- PDO overview (default settings)

RPDO	(CMD)	(LFRD)	(None)	(None)	(None)	(None)
TPDO	(ETA)	(RFRD)	(None)	(None)	(None)	(None)

CMD: Controlword

LFRD: VI_Target_Velocity

ETA: Statusword

RFRD: VI_Velocity_Actual value

The configuration means are:

- EtherCAT configuration tool, then the configuration is downloaded by the master.

***3: Acyclic Services: SDO**

The VF-MB1/S15/AS3 manages a SDO server (Service Data Object). SDO telegrams are used for configuration and adjustment, they are characterized by two identifiers:

- One for requests (telegrams sent from the PLC to the VF-MB1/S15/AS3)
- One for responses (telegrams sent back to the PLC by the VF-MB1/S15/AS3)

3. Names and functions

The drawing below shows names and functions of main parts.

3.1. Outline

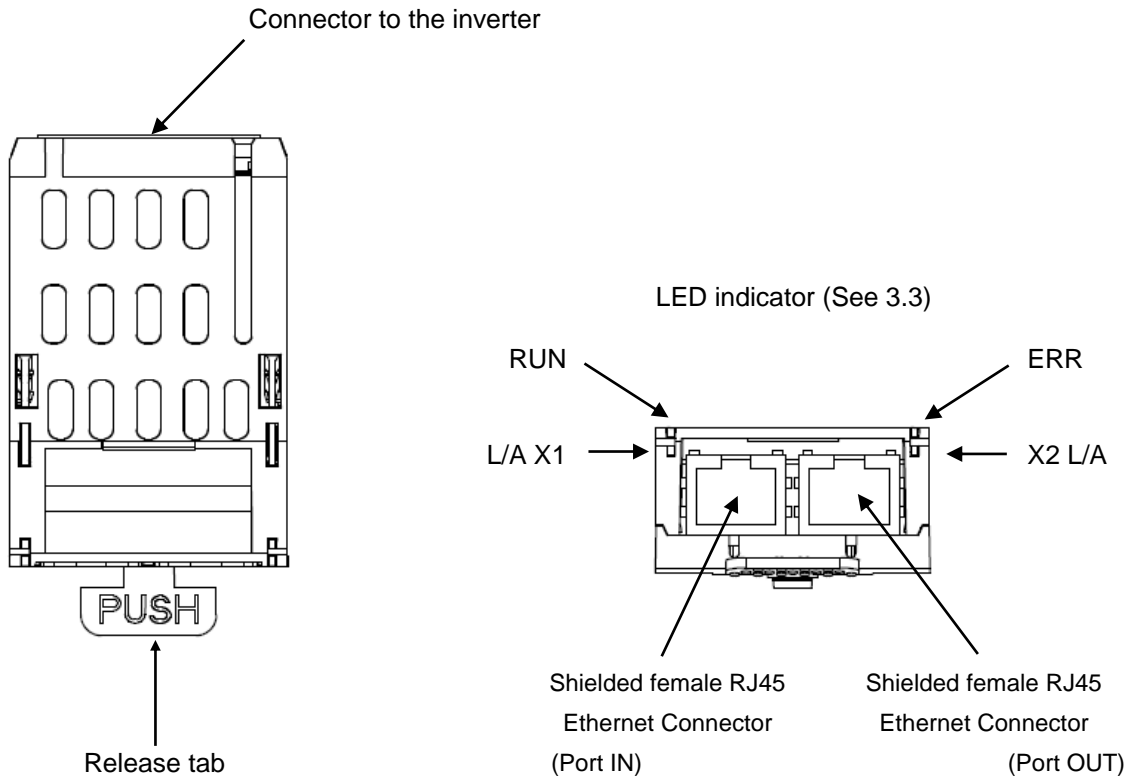

X1 means EtherCAT IN port,
X2 means EtherCAT OUT port

3.2. RJ45 connector pin layout

The EtherCAT® unit is equipped with two shielded RJ45 connectors. When you use VF-MB1/AS3, the shielding is connected to the drive ground. When you use VF-S15, the shielding is connected to the grounding terminal of option adapter.

Use an STP (shielded twisted pair) Ethernet cable.

The transmission speed is detected automatically by the card (100 Mbps).

The card can operate in half duplex or full duplex mode, whether connected to a hub or a switch and regardless of the transmission speed (100 Mbps).

Port IN (X1 L/A EtherCAT)
and Port OUT (X2 L/A EtherCAT)

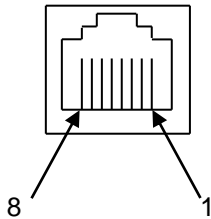

Pin	Signal	Meaning
1	TX+	Ethernet transmit line +
2	TX-	Ethernet transmit line -
3	RX+	Ethernet receive line +
4	-	
5	-	
6	RX-	Ethernet receive line -
7	-	
8	-	

* Fix a cable so that a communication connector may be not taken the weight of wire.

Cable specifications

- Minimum Cat 5e,
- Connector RJ45, no crossover cable
- Shield: both ends grounded
- Twisted pair cable
- Cable: 8 x 0.25 mm² (8 x AWG 22)
- Use pre-assembled cables to reduce the wiring mistakes,
- Verify that wiring, cables and connected interfaces meet the PELV (Protective Extra-Low Voltage) requirements.
- Maximum cable length = 100 m (328 ft)

3.3. Status indicator

3.3.1. LED on the option

The LEDs shows the present status of the network and module.

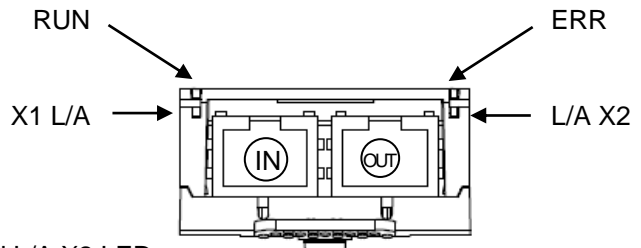

■ The behavior of X1 L/A LED and L/A X2 LED

These LEDs indicate the status of the EtherCAT IN port (X1 L/A) and OUT port (L/A X2)

Color and behavior	Meaning
OFF	No link
Green ON	Link, no activity
Green Flickering	Link, activity

■ The behavior of RUN LED

It LED indicate the RUN status or RUN error

Color and behavior	Meaning
OFF	EtherCAT state: INIT
Green blinking	EtherCAT state: PRE-OPERATIONAL
Green single flashing	EtherCAT state: SAFE-OPERATIONAL
Green ON	EtherCAT state: OPERATIONAL
Red ON	Fatal error
Red Flickering	EtherCAT state: INITIALISATION or BOOTSTRAP

■ The behavior of ERR LED

It LED indicate the network status or network error

Color and behavior	Meaning
OFF	No detected fault
Red ON	Fatal error
Red blinking	Invalid configuration
Red single flashing	Local error (such as synchronization error)
Red double flashing	Watchdog timeout
Red Flickering	Booting Error

LED Behavior Detail

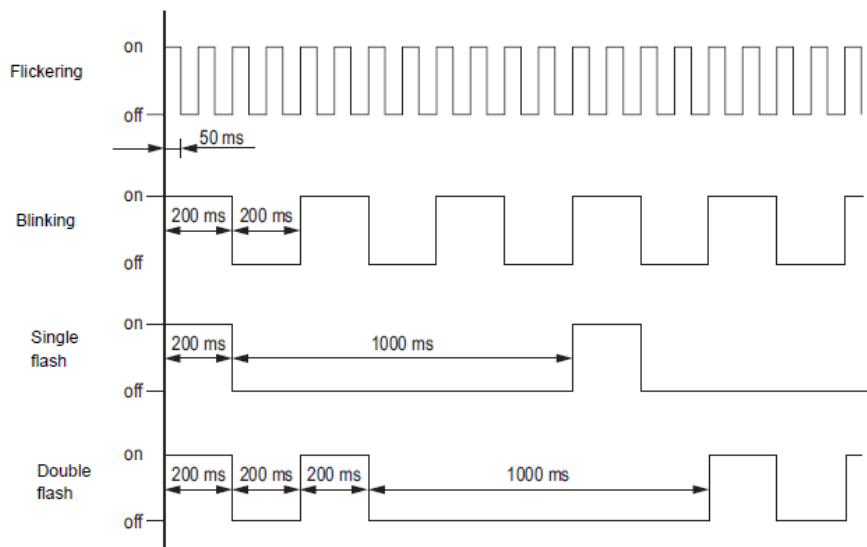

3.3.2. Labels on the inverter (Only for the VF-AS3)

When EtherCAT option is used, please stick the LED label and Link-status information label to VF-AS3. These labels are enclosed with the option.

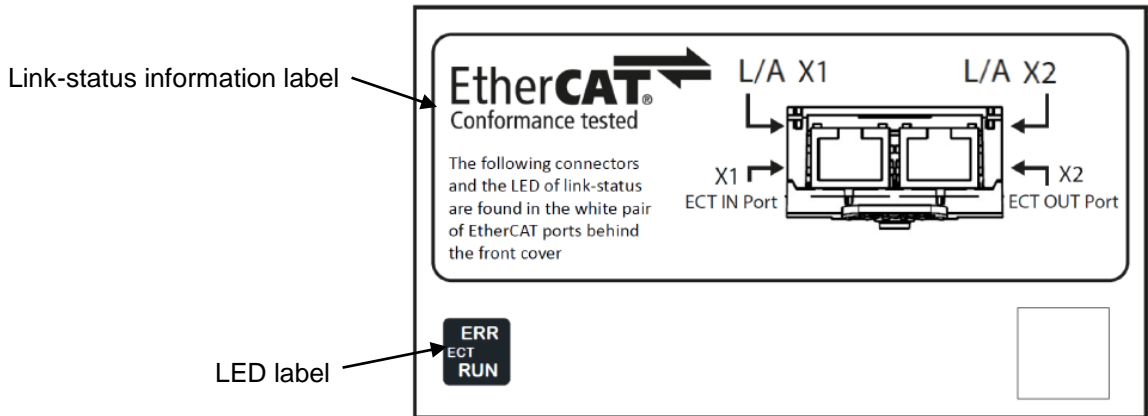

3.3.2.1. LED label

Please stick the LED label for EtherCAT option to lower side of communication indicator of VF-AS3.

ERR is displayed to the NET1-LED together on communication indicator. RUN is displayed to the NET2-LED together on communication indicator. See “3.3.1.LED on the option” about ERR and RUN.

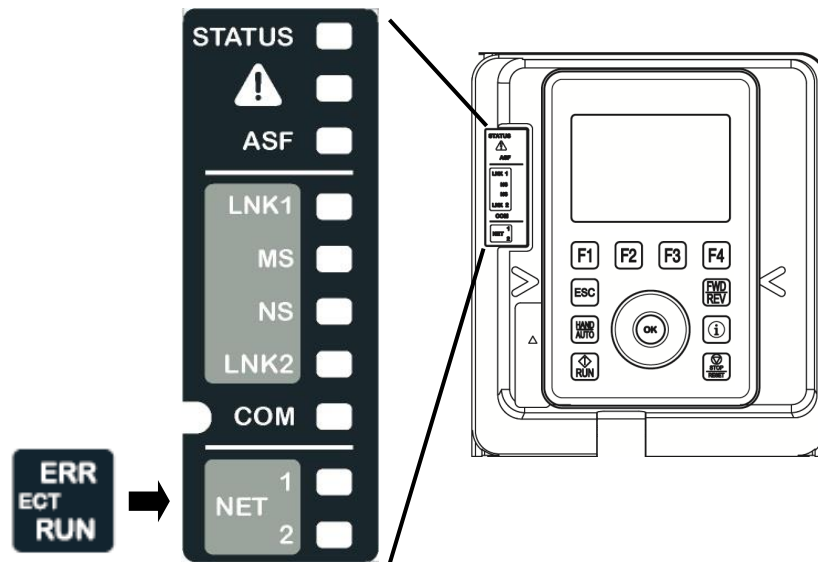

3.3.2.2. Link-status information label

Please stick the Link-status information label to the front cover of VF-AS3. This information needs for the user when the LED of Link-status is checked.

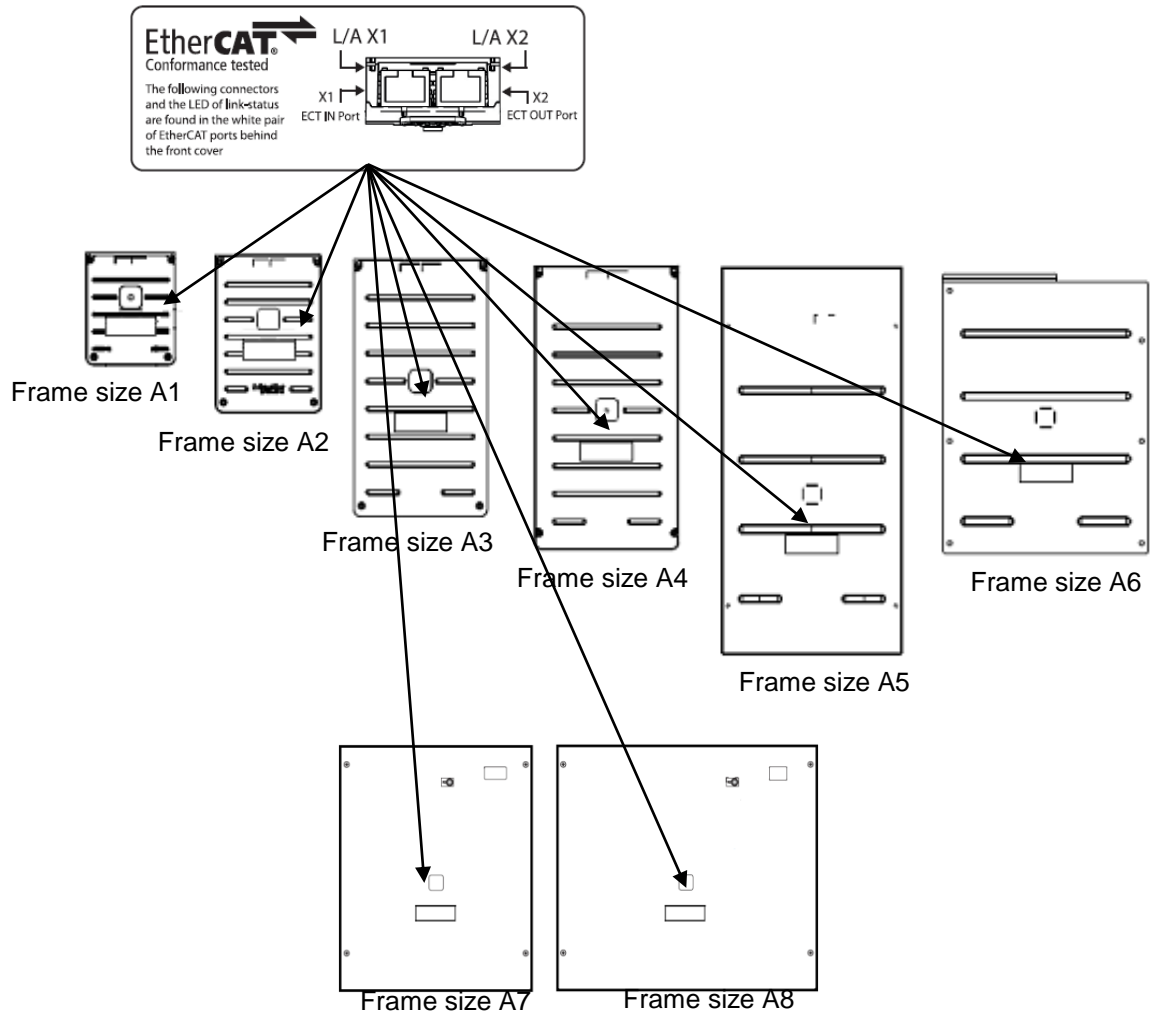

Frame size	Type-Form	
	240V	480V
A1	VFAS3-2004P to 2022P	VFAS3-4004PC to 4037PC
A2	VFAS3-2037P	VFAS3-4055PC, 4075PC
A3	VFAS3-2055P, 2075P	VFAS3-4110PC to 4185PC
A4	VFAS3-2110P to 2185P	VFAS3-4220PC to 4370PC
A5	VFAS3-2220P to 2370P	VFAS3-4450PC to 4750PC
A6	VFAS3-2450P, 2550P	VFAS3-4900PC to 4132KPC
A7	-	VFAS3-4160KPC
A8	-	VFAS3-4200KPC to 4280KPC

Figure: The position of the Link-status information label

⚠ Warning	
 Prohibited	▼ Never remove the front cover when the power is on. Doing so could result in electric shock.

4. Hardware Setup

When using this product with VF-S15, sold separately VF-S15 option adapter (SBP009Z) is required.

4.1. Mounting and removing

Warning



Mandatory
action

- ▼ The mounting/removing of option must be performed without supplying power (Turn off all input power, wait at least 15 minutes, confirm that the charge lamp of inverter is no longer lit). The inverter and option can become damaged.
- ▼ Do not use tool for the mounting/removing of option. The inverter and option can become damaged.

4.1.1. Mounting and removing of option for VF-MB1

Way for mount and remove the option, refer to [Optional external devices] of E6581697.

4.1.2. Mounting and removing of option for VF-S15

Way for mount and remove the option, refer to [Optional external devices] of E6581611.

4.1.3. Mounting and removing of option for VF-AS3

Way for mount and remove the option, refer to [Mounting/removing insert type options] of E6582062.

5. Parameters

5.1. Communication parameters

Set up the drive parameters as follows. It is necessary to reset the drive to update the parameter.
 This option doesn't operate if these parameters are not correctly set.
 Reset by power-on/off or set F899 to 1 after these parameters are set.

VF-MB1/S15

Title	Communication No.	Function	Description	Default (Setting)
<i>CnCd</i>	0003	Command mode selection	0: Terminal board 1: Panel keypad (including remote keypad) 2: RS485 communication 3: CANopen communication 4: Communication option	1 (4)
<i>FnCd</i>	0004	Frequency setting mode selection 1	0: Setting dial 1 (save even if power is off) 1: Terminal board VIA 2: Terminal board VIB 3: Setting dial 2 (press in center to save) 4: RS485 communication 5: UP/DOWN from external logic input 6: CANopen communication 7: Communication option 8: Terminal board VIC 9, 10: - 11: Pulse train input	0 (7)

VF-AS3

Title	Communication No.	Function	Description	Default (Setting)
<i>CnCd</i>	0003	Command mode selection	0: Terminal 1: Operation panel, Extension panel 2: Embedded Ethernet 3: RS485 communication (connector 1) 4: RS485 communication (connector 2) 5: Communication option	0 (5)
<i>FnCd</i>	0004	Frequency setting mode selection 1	0: - 1: Terminal RR 2: Terminal RX 3: Terminal II 4: Terminal AI4 (option) 5: Terminal AI5 (option) 6 - 9: - 10: Touch wheel 1 (power off or press OK to save) 11: Touch wheel 2 (press OK to save) 12: Sr0 13,14: - 15: Terminal Up/Down frequency 16: Pulse train 17: High resolution pulse train (option) 18,19: - 20: Embedded Ethernet 21: RS485 communication (connector 1) 22: RS485 communication (connector 2) 23: Communication option	1 (23)

Title	Communication No.	Function	Description	Default
<i>ACC</i>	0009	Acceleration time 1	VF-MB/S15 : 0.0 – 3600s VF-AS1 : 0.0 – 6000s	Note1) *5
<i>DEC</i>	0010	Deceleration time 1	VF-MB/S15 : 0.0 – 3600s VF-AS1 : 0.0 – 6000s	Note1) *5
<i>FH</i>	0011	Maximum frequency	VF-MB/S15 : 30.0 – 500.0Hz VF-AS1 : 30.0 – 590.0Hz	Note2)
<i>UL</i>	0012	Upper limit frequency	VF-MB/S15 : 0.5 – <i>FH</i> VF-AS1 : 0.0 – <i>FH</i>	Note3) *6
<i>F856</i>	0856	Number of motor pole for communication	1: 2 poles 2: 4 poles 3: 6 poles 4: 8 poles 5: 10 poles 6: 12 poles 7: 14 poles 8: 16 poles	2
<i>F899</i>	0899	Communication function reset	0: - 1: Reset (after execution: 0)	0

Note1) VF-MB1/S15 : 10.0s , VF-AS3 : Parameter values vary depending on the capacity.

Note2) VF-MB1/S15 : 80.0Hz , VF-AS3 : Depending on the setup menu.

Note3) VF-MB1/S15 : 60.0Hz , VF-AS3 : Depending on the setup menu.

5.2. Communication parameters for IPE003Z

note) The parameters with hatching are for monitoring. The value and index of PDO are able to be confirmed by C001 to C026 and C410 to C421. Don't set them to any value.

Title	Communication No.	Function	Description	Default
<i>C001</i>	C001	Scanner input 1 address	0: None 1: <i>F806</i> (Communication command 1) 2: <i>F823</i> (Communication command 2) 3: <i>F807</i> (Frequency command, 0.01Hz) 4: <i>F833</i> (Torque command 0.01%) [VF-AS3] *4 5: <i>F850</i> (Terminal output data from comm.) 6: <i>F851</i> (Analog output (FM) data from comm.) 7: <i>F852</i> (Analog output(AM) data from comm.) [VF-AS3] *4 8: <i>F801</i> (Stall prevention level, %) 9: <i>F441</i> (Power running torque limit 1 level, 0.01%) [VF-AS3] *4 10: <i>F443</i> (Regenerative braking torque limit 1 level, 0.01%) [VF-AS3] *4 11: <i>F460</i> (Speed loop proportional gain) [VF-AS3] *4 12: <i>F461</i> (Speed loop stabilization coefficient) [VF-AS3] *4 13: <i>ACC</i> (Acceleration time 1, 0.1s) *1 14: <i>DEC</i> (Deceleration time 1, 0.1s) *1 15: <i>UL</i> (Upper limit, 0.01Hz) 16: <i>ub</i> (Torque boost value 1, 0.1%) 17: <i>ULV</i> (Base frequency voltage 1, 0.1V) 100: CMD 101: LFRD	100*2
<i>C002</i>	C002	Scanner input 2 address	0-101 (Same as <i>C001</i>)	101*2
<i>C003</i>	C003	Scanner input 3 address	0-101 (Same as <i>C001</i>)	0*2
<i>C004</i>	C004	Scanner input 4 address	0-101 (Same as <i>C001</i>)	0*2
<i>C005</i>	C005	Scanner input 5 address	0-101 (Same as <i>C001</i>)	0*2
<i>C006</i>	C006	Scanner input 6 address	0-101 (Same as <i>C001</i>)	0*2

Title	Communication No.	Function	Description	Default
<i>C021</i>	C021	Scanner output 1 address	0: None 1: <i>Fd01</i> (Inverter status 1) 2: <i>Fd00</i> (Output frequency, 0.01Hz) 3: <i>Fd03</i> (Output current, 0.01%) 4: <i>Fd05</i> (Output voltage, 0.01%) 5: <i>Fc91</i> (Inverter alarm) 6: <i>Fd22</i> (PID feedback value, 0.01Hz) 7: <i>Fd06</i> (Input terminal status) 8: <i>Fd07</i> (Output terminal status) 9: <i>Ff36</i> (VIB input, 0.01%) / <i>Ff35</i> (RR input) [VF-AS3] *4 10: <i>Ff35</i> (VIA input, 0.01%) / <i>Ff36</i> (RX input) [VF-AS3] *4 11: <i>Ff37</i> (VIC input, 0.01%) / <i>Ff37</i> (II input) [VF-AS3] *4 12: <i>Fd04</i> (Input voltage (DC detection), 0.01%) 13: <i>Fd16</i> (Estimated speed (real-time value), 0.01Hz) 14: <i>Fd18</i> (Torque, 0.01%) 15: <i>Ff60</i> (My monitor 1) [VF-AS3] *4 16: <i>Ff61</i> (My monitor 2) [VF-AS3] *4 17: <i>Ff62</i> (My monitor 3) [VF-AS3] *4 18: <i>Ff63</i> (My monitor 4) [VF-AS3] *4 19: <i>F880</i> (Free notes) 20: <i>Fd29</i> (Input power, 0.01kW) 21: <i>Fd30</i> (Output power, 0.01kW) 22: <i>Ff14</i> (Cumulative operation time, 0.01 = 1 hour) 23: <i>Ff40</i> (FM terminal output monitor, 0.01%) 24: <i>Ff41</i> (AM terminal output monitor) [VF-AS3] *4 25: <i>Fd20</i> (Torque current, 0.01%) 26: <i>Fd23</i> (Motor overload factor, 0.01%) 27: <i>Fd24</i> (Drive overload factor, 0.01%) 28: <i>Fd25</i> (PBR overload factor, %) 29: <i>Fd26</i> (Motor load factor, %) 30: <i>Fd27</i> (Drive load factor, %) 31: <i>Ff56</i> (Pulse train input, pps) 32: <i>Ff70</i> (Drive rated current, 0.1A) 33: <i>Ff76</i> (Input Watt-hour, kWh × 10 ^{F749}) 34: <i>Ff77</i> (Output Watt-hour, kWh × 10 ^{F749}) 35: <i>Fd83</i> (IGBT temperature, degree C) 100: ETA 101: RFRD	100*2
<i>C022</i>	C022	Scanner output 2 address	0-101 (Same as <i>C021</i>)	101*2
<i>C023</i>	C023	Scanner output 3 address	0-101 (Same as <i>C021</i>)	0*2
<i>C024</i>	C024	Scanner output 4 address	0-101 (Same as <i>C021</i>)	0*2
<i>C025</i>	C025	Scanner output 5 address	0-101 (Same as <i>C021</i>)	0*2
<i>C026</i>	C026	Scanner output 6 address	0-101 (Same as <i>C021</i>)	0*2
<i>C100</i>	C100	Communication error detection delay time	0.0 - 100.0 sec.	0.0sec
<i>C101</i>	C101	Inverter operation at the communication loss action	0: Stop and controlled by <i>Cn0d, Fn0d</i> 1: Operation continue 2: Deceleration stop 3: Coast stop 4: Network error stop (<i>E r r B</i> trip) 5: Preset speed operation (by <i>C102</i> setting)	4
<i>C102</i>	C102	Preset speed operation selection	0: None 1 to 15: Preset speed	0
<i>C103</i>	C103	Communication time-out condition selection	0: Disconnection detection 1: When communication mode enable (Both <i>Cn0d</i> and <i>Fn0d</i> are set CANopen or communication option) only 2: 1 + Driving operation	0

Title	Communication No.	Function	Description	Default
[400]	C400	EtherCAT slave status	1: INIT Initialization 2: PREOP Pre-operational 3: BOOTTRAP Bootstrap 4: SAFE-OP Safe operational In SAFE-OP mode, inputs are updated in PDOs, outputs are not valid. 8: OP Operational In OP mode, inputs and outputs are valid.	1
[401]	C401	EtherCAT address second	0 - 65535 Address changeable from drive or from master via 2nd address dialog.	0^7
[402]	C402	EtherCAT address Actual value	0 - 65535 The monitor of the EtherCAT address actual value	0^{*3}
[410]	C410	PDO: Command1	Index 0x1600 sub-index 0x01 Command Index No. 0x6040: Controlword	$0x6040^{*3}$
[411]	C411	PDO: Command2	Index 0x1600 sub-index 0x02 Command Index No. 0x6042: vl target velocity	$0x6042^{*3}$
[412]	C412	PDO: Command3	Index 0x1600 sub-index 0x03 Command Index No.	0^{*3}
[413]	C413	PDO: Command4	Index 0x1600 sub-index 0x04 Command Index No.	0^{*3}
[414]	C414	PDO: Command5	Index 0x1600 sub-index 0x05 Command Index No.	0^{*3}
[415]	C415	PDO: Command6	Index 0x1600 sub-index 0x06 Command Index No.	0^{*3}
[416]	C416	PDO: Monitor1	Index 0x1A00 sub-index 0x01 Monitor Index No. 0x6041: vl Statusword	$0x6041^{*3}$
[417]	C417	PDO: Monitor2	Index 0x1A00 sub-index 0x02 Monitor Index No. 0x6044: vl velocity actual value	$0x6044^{*3}$
[418]	C418	PDO: Monitor3	Index 0x1A00 sub-index 0x03 Monitor Index No.	0^{*3}
[419]	C419	PDO: Monitor4	Index 0x1A00 sub-index 0x04 Monitor Index No.	0^{*3}
[420]	C420	PDO: Monitor5	Index 0x1A00 sub-index 0x05 Monitor Index No.	0^{*3}
[421]	C421	PDO: Monitor6	Index 0x1A00 sub-index 0x06 Monitor Index No.	0^{*3}
[858]	C858	VI_Velocity_Max_Amount	0 – 0xFFFF (min^{-1})	$0x05dC(1500)^{*6}$
[860]	C860	VI_Velocity_Acceleration Delta_Speed	0 – 0xFFFF (s)	$0x05dC(1500)^{*5}$
[862]	C862	VI_Velocity_Acceleration Delta_Time	0 – 0xFFFF (min^{-1})	$0x000A(10)^{*5}$
[863]	C863	VI_Velocity_Deceleration Delta_Speed	0 – 0xFFFF (s)	$0x05dC(1500)^{*5}$
[865]	C865	VI_Velocity_Deceleration Delta_Time	0 – 0xFFFF (min^{-1})	$0x000A(10)^{*5}$

*1: Do not change the acceleration/deceleration time unit (parameter F519), if change the parameter, the setting value range will be different from above range.

*2: These parameters are according to $\text{[410]} \sim \text{[421]}$ parameters. These default values were set when the EtherCAT option was installed.

*3: These parameters are set from master (TwinCAT®).

*4: The description and setting are only for the VF-AS3.

*5: Acceleration time 1 (ACC) and deceleration time 1 (DEC) are worked when [704] isn't "Communication option". If [704] is "Communication option", Acceleration and deceleration time 1 are worked by [860] , [862] , [863] , [865] . See "7.1.TOSHIBA Drive profile" for the detailed information.

*6: Upper limit frequency (UL) isn't worked when [858] isn't 0. Set [858] to the upper limit speed. See "7.1.TOSHIBA Drive profile" for the detailed information.

*7: EtherCAT second address ([401]) can't be copied by Remote keypad (RKP002Z, RKP006Z).

Warning



Mandatory action

▼ Set up "Communication error trip function ([100] to [103])" to stop the drive when EtherCAT® communication is deactivated.

5.3. The details of the parameter setting

5.3.1. Network error detection (C 100 - C 103)

▼ Display of trip information

ErrB (Optional unit fault 1: 0x001B): Network error stop

▼ Related parameter

Title	Function	Setting range	Description
C 100	Communication error detection delay time	0.0-100.0 sec	The waiting time from when a network error occurs can be adjusted. If a network error continues past the time set in C 100, it is recognized as a communication error and the operation of the drive follows the setting of C 101. When normal communication returns during the setting time, a communication error is not displayed and operation is continued. *The time unit time-out operates = EtherCAT watchdog + C 100 (communication error detection delay time) [0.1s]
C 101	Inverter operation at the communications loss action	0-5	The operation of the drive when the communication fault occurs can be specified. 0: Stop and Communication release * (follows C 104 and F 104 setting) 1: None 2: Deceleration stop 3: Coast stop 4: Emergency stop 5: Preset speed operation command (Operating at the preset speed operation frequency set with C 102)
C 102	Preset speed operation selection	0-15	The operation frequency of the drive when the communication fault occurs can be specified. (Only when C 101 is set to 5)
C 103	Communication time-out condition selection	0-2	Select the communication time-out condition 0: Disconnection detection 1: When communication mode enable (Both C 104 and F 104 are set CANopen or COM option) 2: 1+Driving operation.

*The behavior of the drive in the system that connected two (or more) drive by the EtherCAT network.

When the cable of OUT of drive at the first position is removed, the drive at the first position did not detect communication abnormality. The drive at the second position detected communication abnormality. The master station was able to send data (LFRD) to drive at the first position. However, information (ETA and RFRD) on the drive was not able to be read.

It seems that TwinCAT's problem.

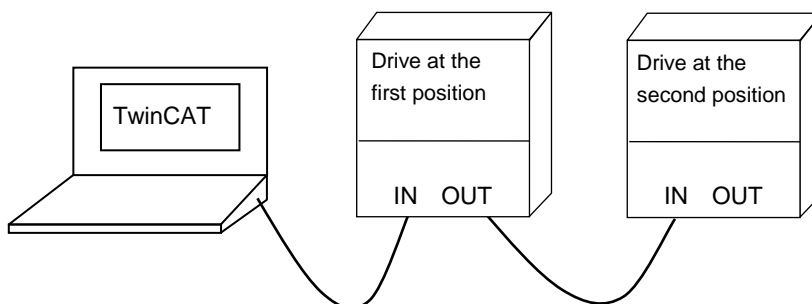

6. Communication Object

Object Dictionary has mainly 3 profile sets.

- Communication profile area (Index 0x1000 to 0x1FFF)
- TOSHIBA drive profile area (Index 0x2000 to 0x5FFF)
- CiA402 drive profile area (Index 0x6000 to 0x9FFF)

Setting and reading to each profile (Index) are operated from master.

See the manual of master in detail.

See “10.3.ESI file (EtherCAT Slave Information)” about the way to integrate ESI file to master (TwinCAT®).

6.1. Communication Profile

These objects are CANopen communication configuration settings. These communication profile object cannot be mapped into PDO.

Index	Sub index	Access	Type	Default value	Description
0x1000	0x00	RO	u32	0x00410192	Device type Bits 24-31 not used (0), Bits 16-23 = Type of device (65) Bits 0-15 = Device profile number (402)
0x1001	0x00	RO	u8	0x00	Error register : Error (= 1) or no error (= 0)
0x1003*	0x00	RO	u8	0x00	Number of errors: Only one possible error (1), located in object #1003 sub 01
	0x01 to 0x10	RO	u32	(Null)	Standard error field: Bits 16-31 = Additional information (always 0) Bits 00-15 = Error code parameter
0x1008	0x00	RO	string	-	Manufacturer device name This value depends on the drive name. ex. VFS15-2007PM
0x1018	0x00	RO	u8	0x04	ID object: Number of objects
	0x01	RO	u32	0x00000284	ID object: Supplier ID 0x00000284 : Toshiba Schneider Inverter Co.
	0x02	RO	u32	0x000000E1	Product code
	0x03	RO	u32	0x00010002	Revision number
	0x04	RO	u32	-	Serial number

*Note: Error code data are cleared of the 0x1003 object when executed the reset from power reset, terminal board, Panel Keypad, FA06 (reset command) and parameter reset ($F899 = 1$).

6.1.1. RPDO: Receive PDO

The mapping of RPDO is shown to the following way.

1. Check the index for mapping by the following list (the description of [000]).
2. Set the index checked by the list to RPDO on master.
See the manual of master in detail.
3. Check the result of the mapping by the value of [000] to [0005] .

<Example: The mapping [Communication command 1] is set to RPDO1>

1. Check the index for mapping by the following list (the description of [000]).
(The index is 0x2A06.)
2. Set 0x2A06 to RPDO1 on master.
3. Check the value of parameter whether mapping is operated correctly.
(If the value of [000] is 1, the mapping is correct.)

<The available mapping list of RPDO>

The available drive profile *1	The description of [000]	Index
TOSHIBA	1: FR05 (Communication command 1)	0x2A06
TOSHIBA	2: FR23 (Communication command 2)	0x2A23
TOSHIBA	3: FR07 (Frequency command, 0.01Hz)	0x2A07
Common	4: FR33 (Torque command 0.01%) [VF-AS3] *2	0x2A33
Common	5: FR50 (Terminal output data from comm.)	0x2A50
Common	6: FR51 (Analog output (FM) data from comm.)	0x2A51
Common	7: FR52 (Analog output(AM) data from comm.) [VF-AS3] *2	0x2A52
Common	8: F501 (Stall prevention level, %)	0x2601
Common	9: F441 (Power running torque limit 1 level, 0.01%) [VF-AS3] *2	0x2441
Common	10: F443 (Regenerative braking torque limit 1 level, 0.01%) [VF-AS3] *2	0x2443
Common	11: F450 (Speed loop proportional gain) [VF-AS3] *2	0x2460
Common	12: F451 (Speed loop stabilization coefficient) [VF-AS3] *2	0x2461
TOSHIBA	13: R11 (Acceleration time 1, 0.1s)	0x2009
TOSHIBA	14: d11 (Deceleration time 1, 0.1s)	0x2010
TOSHIBA	15: UL (Upper limit, 0.01Hz)	0x2012
Common	16: ub (Torque boost value 1, 0.1%)	0x2016
Common	17: uLv (Base frequency voltage 1, 0.1V)	0x2409
CiA402	100: CMD (Controlword)	0x6040
CiA402	101: LFRD (vl_target_velocity min ⁻¹)	0x6042

*1: Don't use TOSHIBA and CiA402 for RPDO mapping at the same time.

*2: The description and setting are only for the VF-AS3.

Index	Sub index	Access	Type	Default value	Description
0x1600	0x00	R/W	u8	0x02	Receive PDO mapping – Number of mapped object: 1 to 6 objects can be mapped for this PDO
	0x01	R/W	u32	0x60400010	Receive PDO mapping – 1st mapped object: Control word "CMD" (0x6040)
	0x02	R/W	u32	0x60420010	Receive PDO mapping – 2nd mapped object: Velocity reference "LFRD" (0x6042)
	0x03	R/W	u32	0x00000000	Receive PDO mapping: 3rd mapped object
	0x04	R/W	u32	0x00000000	Receive PDO mapping: 4th mapped object
	0x05	R/W	u32	0x00000000	Receive PDO mapping: 5th mapped object
	0x06	R/W	u32	0x00000000	Receive PDO mapping: 6th mapped object

6.1.2. TPDO: Transmit PDO

The mapping of TPDO is shown to the following way.

1. Check the index for mapping by the following list (the description of C021).
2. Set the index checked by the list to TPDO on master.
See the manual of master in detail.
3. Check the result of the mapping by the value of C021 to C026 .

<Example: The mapping [Output frequency] is set to RPDO1>

1. Check the index for mapping by the following list (the description of C021).
(The index is 0x2D00.)
2. Set 0x2D00 to TPDO1 on master.
3. Check the value of parameter whether mapping is operated correctly.
(If the value of C021 is 2, the mapping is correct.)

<The available mapping list of TPDO>

The available drive profile *1	The description of C021	Index
TOSHIBA	1: $Fd01$ (Inverter status 1)	0x2D01
TOSHIBA	2: $Fd00$ (Output frequency, 0.01Hz)	0x2D00
Common	3: $Fd03$ (Output current, 0.01%)	0x2D03
Common	4: $Fd05$ (Output voltage, 0.01%)	0x2D05
Common	5: $Fc91$ (Inverter alarm)	0x2C91
Common	6: $Fd22$ (PID feedback value, 0.01Hz)	0x2D22
Common	7: $Fd06$ (Input terminal status)	0x2D06
Common	8: $Fd07$ (Output terminal status)	0x2D07
Common	9: $Ff36$ (VIB input, 0.01%) / $Ff35$ (RR input) [VF-AS3] *2	0x2E36
Common	10: $Ff35$ (VIA input, 0.01%) / $Ff36$ (RX input) [VF-AS3] *2	0x2E35
Common	11: $Ff37$ (VIC input, 0.01%) / $Ff37$ (II input) [VF-AS3] *2	0x2E37
Common	12: $Fd04$ (Input voltage (DC detection), 0.01%)	0x2D04
Common	13: $Fd16$ (Estimated speed (real-time value), 0.01Hz)	0x2D16
Common	14: $Fd18$ (Torque, 0.01%)	0x2D18
Common	15: $Ff60$ (My monitor 1) [VF-AS3] *2	0x2E60
Common	16: $Ff61$ (My monitor 2) [VF-AS3] *2	0x2E61
Common	17: $Ff62$ (My monitor 3) [VF-AS3] *2	0x2E62
Common	18: $Ff63$ (My monitor 4) [VF-AS3] *2	0x2E63
Common	19: $F880$ (Free notes)	0x2880
Common	20: $Fd29$ (Input power, 0.01kW)	0x2D29
Common	21: $Fd30$ (Output power, 0.01kW)	0x2D30
Common	22: $Ff14$ (Cumulative operation time, 0.01 = 1 hour)	0x2D14
Common	23: $Ff40$ (FM terminal output monitor, 0.01%)	0x2E40
Common	24: $Ff41$ (AM terminal output monitor) [VF-AS3] *2	0x2E41
Common	25: $Fd20$ (Torque current, 0.01%)	0x2D20
Common	26: $Fd23$ (Motor overload factor, 0.01%)	0x2D23
Common	27: $Fd24$ (Drive overload factor, 0.01%)	0x2D24
Common	28: $Fd25$ (PBR overload factor, %)	0x2D25
Common	29: $Fd26$ (Motor load factor, %)	0x2D26
Common	30: $Fd27$ (Drive load factor, %)	0x2D27
Common	31: $Ff56$ (Pulse train input, pps)	0x2E56
Common	32: $Ff70$ (Drive rated current, 0.1A)	0x2E70
Common	33: $Ff76$ (Input Watt-hour, $1\text{kWh} \times 10^{749}$)	0x2E76
Common	34: $Ff77$ (Output Watt-hour, $1\text{kWh} \times 10^{749}$)	0x2E77
Common	35: $Fd83$ (IGBT temperature, degree C)	0x2D83
CiA402	100: ETA (Statusword)	0x6041
CiA402	101: RFRD (vl_velocity_actual_value, min ⁻¹)	0x6044

*1: Don't use TOSHIBA and CiA402 for TPDO mapping at the same time.

*2: The description and setting are only for the VF-AS3.



Index	Sub index	Access	Type	Default value	Description
0x1A00	0x00	R/W	u8	0x02	Transmit PDO mapping: Number of mapped object: 1 to 6 objects can be mapped for this PDO
	0x01	R/W	u32	0x60410010	Transmit PDO mapping – 1st mapped object: Status word “ETA” (0x6041)
	0x02	R/W	u32	0x60440010	Transmit PDO mapping – 2nd mapped object: Velocity reference “RFRD” (0x6044/00) default value
	0x03	R/W	u32	0x00000000	Transmit PDO mapping: 3rd mapped object
	0x04	R/W	u32	0x00000000	Transmit PDO mapping: 4th mapped object
	0x05	R/W	u32	0x00000000	Transmit PDO mapping: 5th mapped object
	0x06	R/W	u32	0x00000000	Transmit PDO mapping: 6th mapped object

6.2. TOSHIBA drive profile

All of the parameters are defined as Manufacturer Specific Objects.

Each parameter of inverter can be assigned to each Index No. per following table.

For example, the Comm.No.0x0100 (Title: *F 100*) is defined as Index No.0x2100.

 Warning	
 Prohibited	<p>▼ Do not use application of writing into same parameter more than 100,000 times. The Life of EEPROM is approximately 100,000 times. Do not write to the user parameter area of inverter by SDO to avoid EEPROM broken.</p> <p>No problem by PDO, because it makes only RAM access.</p>

Title	Comm. No. (Hex)	⇒ (Hex)	Index No. (Hex)	Trans. type	Note
<i>AU 1 ~ F 999</i>	0000 ~ 0999	+2000	2000 ~ 2999	SDO PDO *	User parameter area
<i>FA00 ~ FF99</i>	FA00 ~ FF99	-D000	2A00 ~ 2F99	SDO PDO *	Disclosed command and monitor communication No. can be mapped. Refer to the communication manual.
<i>R000 ~ R999</i>	A000 ~ A999	-7000	3000 ~ 3999	SDO	User parameter area
<i>C000 ~ C999</i>	C000 ~ C999	-8000	4000 ~ 4999	SDO	User parameter area

* The parameters in the description of *C 00 1* and *C 02 1* can be mapped to PDO (See “5.2.Communication parameters for IPE003Z”). The mapping of PDO is operated from master. See the manual of master in detail.

6.3. Application Profile (CiA402)

These are standardized parameters in conformance with CiA402 velocity mode.

Title	Index	Sub index	Access	Type	PDO Mapping	Default value	Description
-	0x603F	0x00	RO	u16	No	0x0000	Error code (VFS15)
-	0x6040	0x00	R/W	u16	Yes	0x0000	Control Word
-	0x6041	0x00	RO	u16	Yes	0x0000	Status word
-	0x6042	0x00	R/W	i16	Yes	0x0000	VI_Target_Velocity (min ⁻¹)
-	0x6043	0x00	RO	i16	No	0x0000	VI_Velocity_Demand (min ⁻¹)
-	0x6044	0x00	RO	i16	Yes	0x0000	VI_Velocity_Actual_Value (min ⁻¹)
-	0x6046	0x00	RO	u8	No	0x02	VI Velocity Min Max Amount
-		0x01	R/W	u32	No	0x0000 0000	VI_Velocity_Min_Amount (min ⁻¹)
C858		0x02	R/W	u32	No	0x0000 05DC	VI_Velocity_Max_Amount (min ⁻¹)
-	0x6048	0x00	RO	u8	No	0x02	VI Velocity Acceleration: Highest sub-index supported
C860		0x01	R/W	u32	No	0x0000 05DC	VI_Velocity_Acceleration Delta_Speed (min ⁻¹)
C862		0x02	R/W	u16	No	0x000A	VI_Velocity_Acceleration Delta_Time (s)
-	0x6049	0x00	RO	u8	No	0x02	VI Velocity Deceleration: Highest sub-index supported
C863		0x01	R/W	u32	No	0x0000 05DC	VI_Velocity_Deceleration Delta_Speed (min ⁻¹)
C865		0x02	R/W	u16	No	0x000A	VI_Velocity_Deceleration Delta_Time (s)
-	0x604A	0x00	RO	u8	No	0x02	VI Velocity Quick Stop: Highest sub-index supported
-		0x01	R/W	u32	No	0x0000 05DC	VI_Velocity_Quick_Stop Delta_Speed (min ⁻¹)
-		0x02	R/W	u16	No	0x0006	VI_Velocity_Quick_Stop Delta_Time (s)
-	0x605A	0x00	R/W	i16	No	0x0002	Quick Stop Option Code
-	0x6502	0x00	RO	u32	No	0x0000 0002	Supported drive mode
-	0x6060	0x00	R/W	i8	No	0x02	Mode of operation
-	0x6061	0x00	RO	i8	No	0x02	Mode of operation display

6.4. Abort code (CiA 301)

The abort code in the below table are set in the error response data.

Abort Code	Contents
0503 0000	Toggle bit not alternated.
0504 0000	SDO protocol timed out.
0504 0001	Client/server command specifier not valid or unknown.
0504 0002	Invalid block size (block mode only).
0504 0003	Invalid sequence number (block mode only).
0504 0004	CRC error (block mode only).
0504 0005	Out of memory.
0601 0000	Unsupported access to an object.
0601 0001	Attempt to read a write only object.
0601 0002	Attempt to write a read only object.
0602 0000	Object does not exist in the object dictionary.
0604 0041	Object cannot be mapped to the PDO.
0604 0042	The number and length of the objects to be mapped would exceed PDO length.
0604 0043	General parameter incompatibility reason.
0604 0047	General internal incompatibility in the device.
0606 0000	Access failed due to an hardware error.
0607 0010	Data type does not match, length of service parameter does not match
0607 0012	Data type does not match, length of service parameter too high
0607 0013	Data type does not match, length of service parameter too low
0609 0011	Sub-index does not exist.
0609 0030	Invalid value for parameter (download only).
0609 0031	Value of parameter written too high (download only).
0609 0032	Value of parameter written too low (download only).
0609 0036	Maximum value is less than minimum value.
060A 0023	Resource not available: SDO connection
0800 0000	General error
0800 0020	Data cannot be transferred or stored to the application.
0800 0021	Data cannot be transferred or stored to the application because of local control.
0800 0022	Data cannot be transferred or stored to the application because of the present device state.
0800 0023	Object dictionary dynamic generation fails or no object dictionary is present (e.g. object dictionary is generated from file and generation fails because of an file error).
0800 0024	No data available

7. Running by TOSHIBA drive profile

In this chapter, it is described how to control the drive by TOSHIBA drive profile. On TOSHIBA drive profile, communication command 1 (0x2A06) and communication command 2 (0x2A23) and frequency command (0x2A07) are used as drive command. CiA402 drive profile (CMD, LFRD etc.) can't be used at the same time.

7.1. TOSHIBA Drive profile

The running and monitor of drive can be operated by TOSHIBA drive profile (Communication command 1). The drive can be operated by panel, terminal to select command mode selection (*CMD*), frequency setting mode selection 1 (*FREQ*).

See the following procedure example about the usage.

1. Set 4: Communication option to command mode selection (*CMD*) and Set 7: communication option to frequency setting mode selection 1 (*FREQ*).
Note) In case the drive is VF-AS3, *CMD* is set to 5 and *FREQ* is set to 23.
2. Set to communication command 1 (0x2A06) and frequency command (0x2A07) to RPDO. See 6.1.1 about mapping.
3. Set to 0x0000 to communication command 1 (0x2A06). After that, Set to 0x0400 (bit10: RUN of communication command 1).
4. Set 50.00Hz (=0x1388) to frequency command (0x2A07). As the result, the drive is running at 50Hz.

These diagrams translate as follows for the VF-MB1/S15/AS3 system:

Control diagram:

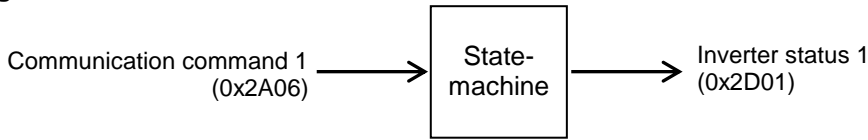

Simplified diagram of speed control:

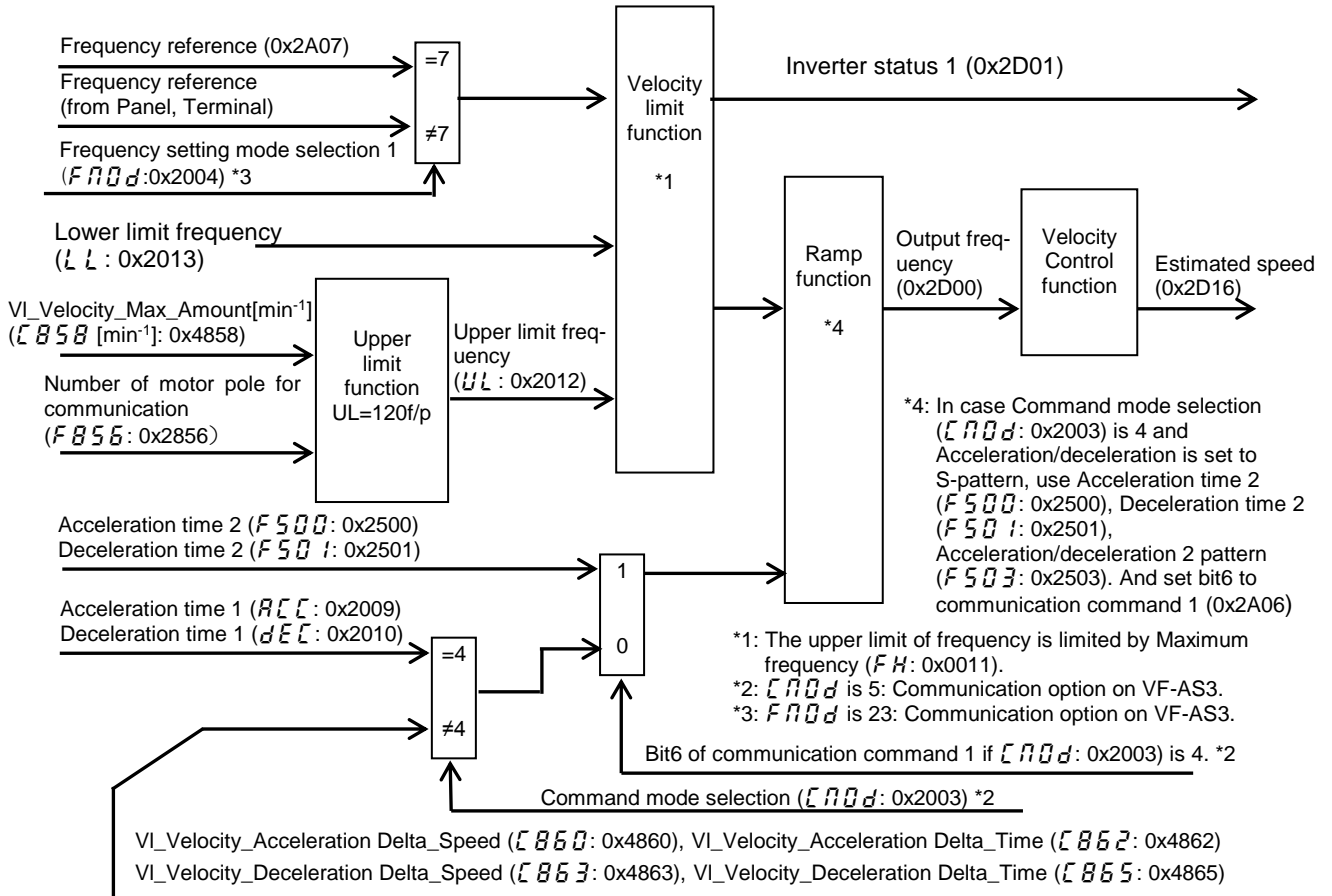

Note) Do not change the acceleration/deceleration time unit (parameter F₅1₉), if change the parameter, the setting value range will be different from above range.

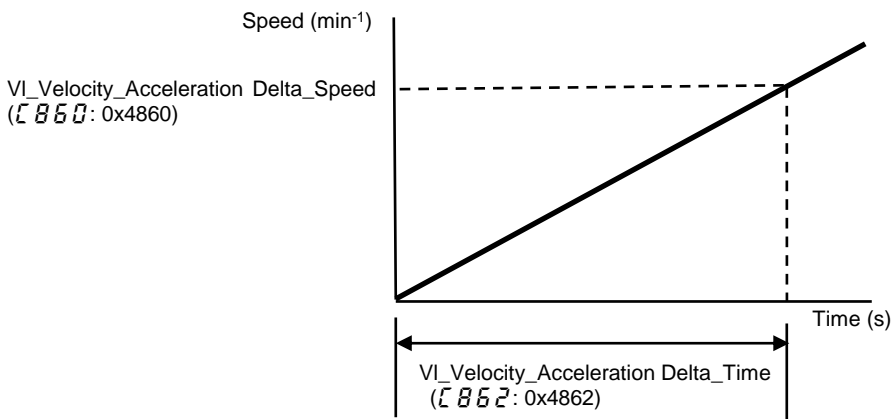

Precaution 1 : Setting of upper limit frequency (UL)

Upper limit frequency (UL) isn't worked when C858 isn't 0. Set C858 to the value of the upper limit speed for CiA402.

<example>

Upper limit frequency (UL) = 200.0Hz

Motor pole number for communication (F856) = 2: 4 pole

VI_Velocity_Max_Amount (C858) = 120 * 200.0Hz / 4 pole = 6000 min⁻¹

In the result, set C858 to 0x1770 (6000 min⁻¹).

Title	Com.No.	function	Description	Default	Setting from panel	Setting from com.
UL	0012	Upper limit frequency	0.5 – FH (Hz)	50.0	The value is set from C858 when the EtherCAT option was installed.	
F856	0856	Motor pole number for communication	1: 2 pole – 8: 16 pole	2: 4 pole	2: 4 pole	2
C858	C858	VI_Velocity_Max_Amount	0 – 0xFFFF (min ⁻¹) (Note)	05dC (1500 min ⁻¹)	1770 (6000 min ⁻¹)	6000

Note) The active range is from Lower limit frequency (LL) to Upper limit frequency (UL). See “8.1.8.Object 0x6046: vl_velocity_min_max_amount” for the detailed information.

Precaution 1 : Setting acceleration time 1 (ACC), deceleration time 1 (DEC)

Acceleration time 1 (ACC), deceleration time 1 (DEC) are worked as standard of maximum frequency (FH) when C70d isn't “Communication option”. If C70d is “Communication option”, acceleration time and deceleration time are worked by C860, C862, C863, C865. In this case, set 0(Linear) to acceleration/deceleration 1 pattern (F502: 0x2502). (S-pattern isn't supported.) If S-pattern is needed, use acceleration/deceleration 2 or 3.

However, acceleration / deceleration pattern selection (2 to 4) are available without the value of C70d.

<example>

Maximum frequency (FH) = 200.0Hz

Motor pole number for communication (F856) = 2: 4 pole

VI_Velocity_Acceleration Delta_Speed (C860) = 120 * 200.0Hz / 4 pole = 6000 min⁻¹

VI_Velocity_Deceleration Delta_Speed (C863) = 6000 min⁻¹ (same value with C860)

In the result, set F860, C863 to 0x1770 (6000 min⁻¹).

VI_Velocity_Acceleration Delta_Time (C862) = Acceleration time 1 (ACC) = 100s

In the result, set F862 to 0x0064 (100s).

VI_Velocity_Deceleration Delta_Time (C865) = Deceleration time 1 (DEC) = 150s

In the result, set F865 to 0x0096 (150s).

VF-MB1/S15

Title	Com.No.	function	Description	Default	Setting from panel	Setting from com.
C70d	0003	Command mode selection	0: Terminal board - 4: Communication option	1: Panel keypad	4: Communication option	4
FH	0011	Maximum frequency	30.0 – 500.0Hz	80.0	200.0	20000
ACC	0009	Acceleration time 1	0.0 – 3600s	10.0	100.0	1000
DEC	0010	Deceleration time 1	0.0 – 3600s	10.0	150.0	1500
F856	0856	Number of motor pole for communication	1: 2 poles – 8: 16 poles	2: 4 poles	2: 4 poles	2
C860	C860	VI_Velocity_Acceleration Delta_Speed	0 – 0xFFFF (s)	05dC (1500min ⁻¹)	1770 (6000min ⁻¹)	6000
C862	C862	VI_Velocity_Acceleration Delta_Time	0 – 0xFFFF (min ⁻¹)	000A (10s)	0064 (100s)	100
C863	C863	VI_Velocity_Deceleration Delta_Speed	0 – 0xFFFF (s)	05dC (1500min ⁻¹)	1770 (6000min ⁻¹)	6000
C865	C865	VI_Velocity_Deceleration Delta_Time	0 – 0xFFFF (min ⁻¹)	000A (10s)	0096 (150s)	150

VF-AS3

Title	Com.No.	function	Description	Default	Setting from panel	Setting from com.
<i>CNDd</i>	0003	Command mode selection	0: Terminal board - 5: Communcation option	<i>/</i> : Panel keypad	<i>5</i> : Communcation option	5
<i>FH</i>	0011	Maximum frequency	30.0 – 500.0Hz	<i>80.0</i>	<i>200.0</i>	20000
<i>ACC</i>	0009	Acceleration time 1	0.0 – 3600s	<i>10.0</i>	<i>100.0</i>	1000
<i>DEC</i>	0010	Deceleration time 1	0.0 – 3600s	<i>10.0</i>	<i>150.0</i>	1500
<i>FBS6</i>	0856	Number of motor pole for communication	1: 2 poles – 8: 16 poles	2: 4 poles	2: 4 poles	2
<i>C860</i>	C860	VI_Velocity_Acceleration Delta_Speed	0 – 0xFFFF (s) Note)	<i>05dC</i> (1500min ⁻¹)	<i>1770</i> (6000min ⁻¹)	6000
<i>C862</i>	C862	VI_Velocity_Acceleration Delta_Time	0 – 0xFFFF (min ⁻¹) Note)	<i>000A</i> (10s)	<i>0064</i> (100s)	100
<i>C863</i>	C863	VI_Velocity_Deceleration Delta_Speed	0 – 0xFFFF (s) Note)	<i>05dC</i> (1500min ⁻¹)	<i>1770</i> (6000min ⁻¹)	6000
<i>C865</i>	C865	VI_Velocity_Deceleration Delta_Time	0 – 0xFFFF (min ⁻¹) Note)	<i>000A</i> (10s)	<i>0096</i> (150s)	150

Note) The active range is defined by each object. See “8.1.9.Object 0x6048: vl_velocity_acceleration” and “8.1.10.Object 0x6049: vl_velocity_deceleration” for the detailed information.

7.1.1. *FRO6* : 0x2A06 (Communication command1)

Set *FRO6* to 0 (bit 7: DC braking and bit 10: Run/stop) after power-on or reset. The drive isn't able to run if *FRO6* isn't set to 0. This function is for safety to protect an unexpected run.

VF-MB1/S15

bit	Function	0	1	Note
0	Preset speed operation frequencies 1	Preset speed operation is disabled or preset speed operation frequencies (1-15) are set by specifying bits for preset speed operation frequencies 1-4. (0000: Preset speed operation OFF*1, 001-1111: Setting of preset speed operation frequencies (1-15))		
1	Preset speed operation frequencies 2			
2	Preset speed operation frequencies 3			
3	Preset speed operation frequencies 4			
4	Motor selection (1 or 2) (THR 2 selection)	Motor 1 (THR 1)	Motor 2 (THR 2)	THR1: <i>Pt</i> = setting value, <i>uL</i> , <i>uLu</i> , <i>ub</i> , <i>tHr</i> THR2: <i>Pt</i> = 0, <i>F170</i> , <i>F171</i> , <i>F172</i> , <i>F173</i>
5	PID control OFF	PID control permitted	PID control prohibited	-
6	Acceleration/deceleration pattern selection (1 or 2) (AD2 selection)	Acceleration/deceleration pattern 1 (AD1)	Acceleration/deceleration pattern 2 (AD2)	AD1: <i>ACC</i> , <i>DEC</i> *2 AD2: <i>F500</i> , <i>F501</i>
7	DC braking	OFF	Forced DC braking	-
8	Jog run	OFF	Jog run	-
9	Forward/reverse run selection	Forward run	Reverse run	-
10	Run/stop	Stop	Run	-
11	Coast stop command	Standby	Cost stop	-
12	Emergency stop	OFF	Emergency stop	Always enable, "E" trip
13	Fault reset	OFF	Reset	
14	Frequency priority selection	OFF	Enabled	Enabled regardless of the setting of <i>FNDd</i>
15	Command priority selection	OFF	Enabled	Enabled regardless of the setting of <i>CNDd</i>

(*1): VF-S15: When 14(*Sr0*) is set to *FNOd*, preset speed operation frequency 0 is selected.

(*2): Acceleration time 1 (*ACC*) and deceleration time 1 (*DEC*) are worked when *CNOd* isn't "Communication option". If *CNOd* is "Communication option", Acceleration and deceleration time 1 are worked by *C860*, *C862*, *C863*, *C865*. See "7.1.TOSHIBA Drive profile" for the detailed information.

In this case, set 0(Linear) to acceleration/deceleration 1 pattern (*F502*: 0x2502). (S-pattern isn't supported.) If S-pattern is needed, use acceleration/deceleration 2 or 3.

VF-AS3

bit	Function	0	1	Note
0	Preset speed switching 1	0000: Preset speed operation OFF (*1) 0001-1111: Setting of preset speed operation frequencies (1-15)		Preset speed operation is disabled or preset speed operation frequencies (1-15) are set by specifying bits for preset speed operation frequencies 1-4.
1	Preset speed switching 2			
2	Preset speed switching 3			
3	Preset speed switching 4			
4	V/f switching 1 (*2)	V/f 1	V/f 2	V/f 1: <i>Pt</i> = setting value, <i>uL</i> , <i>uLu</i> , <i>ub</i> , <i>tHrR</i> V/f 2: <i>Pt</i> = "0", <i>F170</i> , <i>F171</i> , <i>F172</i> , <i>F182</i>
5	PID control OFF	PID control permitted	PID control prohibited	-
6	Acc/Dec switching 1 (*3)	AD mode 1	AD mode 2	AD mode 1: <i>ACC</i> , <i>DEC</i> (*4) AD mode 2: <i>F500</i> , <i>F501</i>
7	DC braking	OFF	Forced DC braking	-
8	Jog run	OFF	Jog run	-
9	Forward/Reverse	Forward run	Reverse run	-
10	Run/Stop	Stop	Run	-
11	Coast stop	Standby	Cost stop	-
12	Emergency off	OFF	Emergency off	Always enable, [E] trip
13	Fault reset	OFF	Reset	Trip reset
14	Frequency priority	OFF	Enabled	Enabled regardless of the setting of <i>FNOd</i>
15	Command priority	OFF	Enabled	Enabled regardless of the setting of <i>CNOd</i>

(*1): When set "12(*Sr0*)" to *FNOd*, preset speed operation frequency 0 is selected.

(*2): The V/f switching ORs with Bit 10 of *FR23*.

(*3): The Acc/Dec switching ORs with Bit 8 of *FR23*.

(*4): Acceleration time 1 (*ACC*) and deceleration time 1 (*DEC*) are worked when *CNOd* isn't "Communication option". If *CNOd* is "Communication option", Acceleration and deceleration time 1 are worked by *C860*, *C862*, *C863*, *C865*. See "7.1.TOSHIBA Drive profile" for the detailed information.

In this case, set 0(Linear) to acceleration/deceleration 1 pattern (*F502*: 0x2502). (S-pattern isn't supported.) If S-pattern is needed, use acceleration/deceleration 2 or 3 or 4.

7.1.2. *FA23* : 0x2A23 (Communication command 2)

VF-MB1/S15

bit	Function	0	1	Note
0	(Reserved)	-	-	-
1	Electric power quantity reset	OFF	Reset	Electric power quantity (<i>FE76</i> , <i>FE77</i>) reset
2	(Reserved)	-	-	-
3	(Reserved)	-	-	-
4	(Reserved)	-	-	-
5	(Reserved)	-	-	-
6	(Reserved)	-	-	-
7	Maximum deceleration forced stop	Normal	Enabled	-
8	Acceleration/deceleration selection 1	00: Acceleration/deceleration 1 01: Acceleration/deceleration 2 10: Acceleration/deceleration 3		Select acceleration/deceleration 1-3 by combination of two bits. AD1: <i>ACC</i> , <i>dEC</i> *1 AD2: <i>F500</i> , <i>F501</i> AD3: <i>F510</i> , <i>F511</i>
9	Acceleration/deceleration selection 2			
10	(Reserved)	-	-	-
11	(Reserved)	-	-	-
12	OC stall level switch	OC stall 1	OC stall 2	OC stall 1: <i>F601</i> OC stall 2: <i>F185</i>
13	(Reserved)	-	-	-
14	(Reserved)	-	-	-
15	(Reserved)	-	-	-

Note: Set 0 to reserved bit.

(*1): Acceleration time 1 (*ACC*) and deceleration time 1 (*dEC*) are worked when *ENOD* isn't "Communication option". If *ENOD* is "Communication option", Acceleration and deceleration time 1 are worked by *CB60*, *CB62*, *CB63*, *CB65*. See "7.1.TOSHIBA Drive profile" for the detailed information.

In this case, set 0(Linear) to acceleration/deceleration 1 pattern (*F502*: 0x2502).(S-pattern is n't supported.) If S-pattern is needed, use acceleration/deceleration 2 or 3.

VF-AS3

bit	Function	0	1	Note
0	Control switching	Speed control	Torque control	-
1	Electric power quantity reset	OFF	Reset	Electric power quantity (<i>FE 76</i> , <i>FE 77</i>) reset
2	(Reserved)	-	-	-
3	Braking request (BC)	Normal	Forcibly braked	-
4	Preliminary excitation	Normal	Enabled	-
5	(Reserved)	-	-	-
6	Braking answer (BA)	Brake applied	Brake released	-
7	Quick deceleration 2	Normal	Enabled	-
8	Acc/dec switching 1 (*1)	00: AD mode 1 01: AD mode 2 10: AD mode 3 11: AD mode 4		Select Acc/Dec mode 1 - 4 by combination of two bits. AD mode 1: <i>ACC</i> , <i>DEC</i> *3 AD mode 2: <i>F500</i> , <i>F501</i> AD mode 3: <i>F510</i> , <i>F511</i> AD mode 4: <i>F514</i> , <i>F515</i>
9	Acc/dec switching 2			
10	V/f switching 1 (*2)			Select V/f pattern 1 - 4 by combination of two bits V/f 1: $P_t =$ setting value, v_L , $v_L v$, v_b , t_{HrA} V/f 2: $P_t =$ "0", <i>F170</i> , <i>F171</i> , <i>F172</i> , <i>F182</i> V/f 3: $P_t =$ "0", <i>F174</i> , <i>F175</i> , <i>F176</i> , <i>F183</i> V/f 4: $P_t =$ "0", <i>F178</i> , <i>F179</i> , <i>F180</i> , <i>F184</i>
11	V/f switching 2	00: V/f 1 01: V/f 2 10: V/f 3 11: V/f 4		
12	OC stall level switching and Torque limit switching 1			OC stall 1: <i>F601</i> OC stall 2: <i>F185</i>
13	Torque limit switching 2	00: Torque limit 1 / OC stall 1 01: Torque limit 2 / OC stall 2 10: Torque limit 3 / OC stall 1 11: Torque limit 4 / OC stall 2		Select torque limit 1 - 4 by combination of two bits Torque limit 1: <i>F441</i> , <i>F443</i> Torque limit 2: <i>F444</i> , <i>F445</i> Torque limit 3: <i>F446</i> , <i>F447</i> Torque limit 4: <i>F448</i> , <i>F449</i>
14	Speed gain switching	Gain 1	Gain 2	Gain 1: <i>F460</i> , <i>F461</i> , <i>F462</i> Gain 2: <i>F463</i> , <i>F464</i> , <i>F465</i>
15	(Reserved)	-	-	-

Note: Set 0 to reserved bit.

(*1): The Acc/Dec switching ORs with Bit 6 of *FAD6*. When changing Acc/Dec in four types, set Bit 6 of *FAD6* to "0" and use *FA23*.

(*2): The V/f switching ORs with Bit 4 of *FAD6*. When changing V/f in four types, set Bit 4 of *FAD6* to "0" and use *FA23*.

(*3): Acceleration time 1 (*ACC*) and deceleration time 1 (*DEC*) are worked when *ENOD* isn't "Communication option". If *ENOD* is "Communication option", Acceleration and deceleration time 1 are worked by *CB60*, *CB62*, *CB63*, *CB65*. See "7.1.TOSHIBA Drive profile" for the detailed information.

In this case, set 0(Linear) to acceleration/deceleration 1 pattern (*F502*: 0x2502). (S-pattern isn't supported.) If S-pattern is needed, use acceleration/deceleration 2 or 3 or 4.

7.1.3. *FR07* : 0x2A07 (Frequency reference from internal option)

Frequency reference is set up by 0.01Hz unit and the hexadecimal number.

For example, when "Frequency reference" is set up to 80Hz, since the minimum unit is 0.01Hz,

$$80 / 0.01 = 8000 = 0x1F40$$

7.1.4. *FR33* : 0x2A33 (Torque command) (Only for the VF-AS3)

Torque reference is set up by 0.01% unit and the hexadecimal number.

For example: when "torque command" is set up to "50%", since the minimum unit is 0.01%,

$$50\% = 50 \div 0.01 = 5000 = 0x1388$$

7.1.5. *FR50* : 0x2A50 (Terminal output data from communication)

By setting up the data of the bit 0 - 1 of terminal output data (*FR50*) from communication, setting data (OFF or ON) can be outputted to the output terminal.

[VF-MB1/S15]

Please select the functional number 92 - 95 as the selection (*F130* - *F138*) of the output terminal function before using it.

[VF-AS3]

Please select the functional number 92 - 105 as the selection (*F130* - *F134*, *F159* - *F163*) of the output terminal function before using it.

bit	Output TB function name	0	1
0	Specified data output 1 (Output terminal No.: 92, 93)	OFF	ON
1	Specified data output 2 (Output terminal No.: 94, 95)	OFF	ON
2	[VF-MB1/S15] (Reserved) [VF-AS3] Specified data output 3 (Output terminal No.: 96, 97)	OFF	ON
3	[VF-MB1/S15] (Reserved) [VF-AS3] Specified data output 4 (Output terminal No.: 98, 99)	OFF	ON
4	[VF-MB1/S15] (Reserved) [VF-AS3] Specified data output 5 (Output terminal No.: 100, 101)	OFF	ON
5	[VF-MB1/S15] (Reserved) [VF-AS3] Specified data output 6 (Output terminal No.: 102, 103)	OFF	ON
6	[VF-MB1/S15] (Reserved) [VF-AS3] Specified data output 7 (Output terminal No.: 104, 105)	OFF	ON
7-15	(Reserved)	-	-

Note: Set 0 to reserved bit

7.1.6. *F A 5 1* : 0x2A51(Analog output (FM) data from communication)**7.1.7. *F A 5 2* : 0x2A52(Terminal AM output data) (Only for the VF-AS3)**

Use this function, set the Terminal FM function (*F A 5 1*) or Terminal AM function (*F A 5 2*) to communication data output (18 for VF-S15 / 31 for VF-AS3).

It possible to send out the data specified as FM/AM analog output data (*F A 5 1*/*F A 5 2*) though the FM/AM analog output terminal. Data can be adjusted in a range of 0 to 100.0% (resolution of 10 bit).

Please refer to "Meter setting and adjustment" Section of the VF-S15/MB1 instruction manual for details.

Please refer to "Adjusting the meter connected to the inverter" Section of the VF-AS3 instruction manual for more details.

7.1.8. *F 4 4 1* : 0x2441 (Power running torque limit level 1)(Only for the VF-AS3)**7.1.9. *F 4 4 3* : 0x2443 (Regenerative torque limit level 1)(Only for the VF-AS3)**

Torque limit level is set up by 0.01% unit and the hexadecimal number.

For example: when "Torque limit level " is set up to "250%", since the minimum unit is 0.01%,
 $250\% = 250 \div 0.01 = 25000 = 0x61A8$

7.1.10. *F 4 6 0* : 0x2460 (Speed control response 1)(Only for the VF-AS3)

Speed control response is set up by 0.01% unit and the hexadecimal number.

For example: when "Speed control response " is set up to "1.0%", since the minimum unit is 0.1%,
 $1\% = 1 \div 0.1 = 10 = 0x000A$

7.1.11. *F 4 6 1* : 0x2461 (Speed control stabilization coefficient 1)(Only for the VF-AS3)

Speed control stabilization coefficient is set up by 0.01% unit and the hexadecimal number.

For example: when "Speed control stabilization coefficient " is set up to "1.00%", since the minimum unit is 0.01%,

$1\% = 1 \div 0.01 = 100 = 0x0064$

7.1.12. Fd01 : 0x2D01 (Inverter operating status 1 (real time))

VF-MB1/S15

bit	Function	0	1	Note
0	Failure FL	No output	Under in progress	-
1	Failure	Not tripped	Tripped	Trip status includes <i>rtr</i> and the trip retention status are also regarded as tripped statuses.
2	Alarm	No alarm	Alarm issued	-
3	Under voltage (<i>NOFF</i>)	Normal	Under voltage	-
4	Motor selection (1 or 2) (THR 2 selection)	Motor 1 (THR1)	Motor 2 (THR2)	THR1: <i>Pt</i> = setting value, <i>uL</i> , <i>uLv</i> , <i>ub</i> , <i>tHr</i> THR2: <i>Pt</i> = 0, <i>F170</i> , <i>F171</i> , <i>F172</i> , <i>F173</i>
5	PID control OFF	PID control permitted	PID control prohibited	-
6	Acceleration/deceleration pattern selection (1 or 2)	Acceleration/deceleration pattern 1 (AD1)	Acceleration/deceleration pattern 2 (AD2)	AD1: <i>ACC</i> , <i>DEC</i> *1 AD2: <i>F500</i> , <i>F501</i>
7	DC braking	OFF	Forced DC braking	-
8	Jog run	OFF	Jog run	-
9	Forward / reverse run	Forward run	Reverse run	-
10	Run/stop	Stop	Run	-
11	Coast stop (ST = OFF)	ST=ON	ST=OFF	-
12	Emergency stop	No emergency stop status	Emergency stop status	-
13	Standby ST=ON	Start-up process	Standby	Standby: Initialization completed, not failure stop status, not alarm stop status (<i>NOFF</i> , <i>LL</i> forced stop), ST=ON, and RUN=ON
14	Standby	Start-up process	Standby	Standby: Initialization completed, not failure stop status and not alarm stop status (<i>NOFF</i> , <i>LL</i> forced stop)
15	(Undefined)	-	-	-

Note: The bit described "Undefined" is unstable. Don't use the bit for the judgment.

(*1): Acceleration time 1 (*ACC*) and deceleration time 1 (*DEC*) are worked when *ENOD* isn't "Communication option". If *ENOD* is "Communication option", Acceleration and deceleration time 1 are worked by *CB60*, *CB62*, *CB63*, *CB65*. See "7.1.TOSHIBA Drive profile" for the detailed information.

VF-AS3

bit	Function	0	1	Note
0	Failure FL	No output	Under in progress	-
1	Failure	Not tripped	Tripped	Trip status includes [r t r y] and the trip retention status is also regarded as tripped statuses.
2	Alarm	No alarm	Alarm issued	When DeviceNet network is disconnected, this bit becomes "1"
3	Under voltage (MOFF)	Normal	Under voltage	-
4	V/f switching status	V/f 1	V/f 2	V/f 1: P _t = setting value, u _L , u _L u, u _b , t _{HrA} V/f 2: P _t = 0, F 170, F 171, F 172, F 182
5	PID control OFF	PID control permitted	PID control prohibited	-
6	Acc/Dec switching status	AD mode 1	AD mode 2	AD mode 1: ACC, dEC *1 AD mode 2: F500 .F501
7	DC braking	OFF	Forced DC braking	-
8	Jog run	OFF	Jog run	-
9	Forward / reverse run	Forward run	Reverse run	-
10	Run/stop	Stop	Run	-
11	Coast stop (ST = OFF)	ST=ON	ST=OFF	-
12	Emergency stop	No emergency stop status	Emergency stop status	-
13	Standby ST=ON	Start-up process	Standby	Standby: Initialization completed, not failure stop status, not alarm stop status (moff), [C OFF], [C OFF], [L St P]), ST =ON and RUN=ON
14	Standby	Start-up process	Standby	Standby: Initialization completed, not failure stop status and not alarm stop status ([MOFF], [C OFF], [C OFF], [L St P])
15	HAND/AUTO (LOC/REM)	AUTO (LOC)	HAND (REM)	Enabled with [F 750]="2" HAND: Panel operation is enabled AUTO: Operation method selected [C NOd] and [F NOd] are enabled. Enabled with [F 732]="0" LOC: Panel operation is enabled REM: Operation method selected [C NOd] and [F NOd] are enabled.

(*1): Acceleration time 1 (ACC) and deceleration time 1 (dEC) are worked when CNOd isn't "Communication option". If CNOd is "Communication option", Acceleration and deceleration time 1 are worked by C860, C862, C863, C865. See "7.1.TOSHIBA Drive profile" for the detailed information.

7.1.13. *F d 0 0* : 0x2D00 (Output frequency (real time))

The current output frequency is read into 0.01Hz of units and by the hexadecimal number.
For example, when the output frequency is 80Hz, 0x1F40 (hexadecimal number) are read.

Since the minimum unit is 0.01%,

$$0x1F40 \text{ (Hex.)} = 8000 \text{ (Dec.)} * 0.01 = 80 \text{ (Hz)}$$

Also about the following parameters, these are the same as this.

- *F d 2 2* (Feedback value of PID (real time))..... Unit: 0.01Hz
- *F d 1 6* (Estimated speed (real time)) Unit: 0.01Hz
- *F d 2 9* (Input power (real time)) Unit: 0.01kW
- *F d 3 0* (Output power (real time)) Unit: 0.01kW

7.1.14. *F d 0 3* : 0x2D03 (Output current (real time))

The output current is read into 0.01% of units and by the hexadecimal number.

For example, when the output current of the rated current 4.8A drive is 50% (2.4A), 0x1388 (hexadecimal number) is read out.

Since the minimum unit is 0.01%,

$$0x1388 \text{ (Hex.)} = 5000 \text{ (Dec.)} * 0.01 = 50 \text{ (%)}$$

Also about the following parameters, these are the same as this.

- *F d 0 5* (Output voltage (real time)) Unit: 0.01% (V)
- *F d 0 4* (Voltage at DC bus (real time)) Unit: 0.01% (V)
- *F d 1 8* (Torque) Unit: 0.01% (N·m) *

* When the motor information connected to the drive set to the parameter (*F 4 0 5* - *F 4 1 5*), torque monitor value "100%" is same as the rated torque of a motor in general.

7.1.15. *FE35*:0x2E35, *FE36*: 0x2E36, *FE37*: 0x2E37 (Monitoring of the analog input)

VF-MB1/S15

VIA input value: "Communication Number *FE35*"

VIB input value: "Communication Number *FE36*"

VIC input value: "Communication Number *FE37*"

These monitors can also be used as A/D converters irrespective of the inverter's control.

VIA / VIC input value monitor is capable of reading the data from external devices in a range of 0.00 to 100.00% (unsigned data: 0x0000 to 0x2710).

VIB input value monitor is capable of reading the data from external devices in a range of -100.00 to 100.00% (signed data: 0xD8F0 to 0x2710).

If analog input mode is selected with the frequency setting mode selection parameter, however, keep in mind that any data entered via an analog terminal is regarded as a frequency command.

VF-AS3

RR input value: "Communication Number *FE35*"

RX input value: "Communication Number *FE36*"

II input value: "Communication Number *FE37*"

These monitors can also be used as A/D converters irrespective of the inverter's control.

RR / II input value monitor is capable of reading the data from external devices in a range of 0.00 to 100.00% (unsigned data: 0x0000 to 0x2710).

RX input value monitor is capable of reading the data from external devices in a range of -100.00 to 100.00% (signed data: 0xD8F0 to 0x2710).

If analog input mode is selected with the frequency setting mode selection parameter, however, keep in mind that any data entered via an analog terminal is regarded as a frequency command.

7.1.16. *FE14* : 0x2E14 (Cumulative run time)

The operated cumulative time is read by the hexadecimal number.

For example, when cumulative operation time is 18 hours, 0x12 (18 hours) is read.

0x12 (Hex.) = 18 (Dec., hour)

7.1.17. *FE40* :0x2E40 (Analog output (FM))

7.1.18. *FE41* :0x2E41 (AM output monitor) (Only for the VF-AS3)

The output value of FM/AM terminal is read.

The value range is set to 0 to 10000 (0x2710).

For example, when FM/AM output value is 50.00%, 0x1388 (Hex.) is read.

0x1388 (Hex) = 50.00 (Dec %)

* If the parameter *FE81* (Analog output) is set to 0, FM output monitor cannot be used.

Please set 1 or 2 to *FE81*.

7.1.19. F [9] :0x2C91 (Alarm code)

VF-S15/MB1

bit	Function	0	1	Remarks (Code displayed on the panel)
0	Over-current alarm	Normal	Alarming	[C] flicking
1	Inverter over load alarm	Normal	Alarming	[L] flicking
2	Motor over load alarm	Normal	Alarming	[L] flicking
3	Over heat alarm	Normal	Alarming	[H] flicking
4	Over voltage alarm	Normal	Alarming	[P] flicking
5	Main circuit undervoltage alarm	Normal	Alarming	-
6	main device overheat alarm	Normal	Alarming	[L] flicking
7	Under current alarm	Normal	Alarming	-
8	Over-torque alarm	Normal	Alarming	-
9	Braking resistor overload alarm	Normal	Alarming	-
10	Cumulative operation hours alarm	Normal	Alarming	-
11	Option communication alarm	Normal	Alarming	-
12	Serial communication alarm	Normal	Alarming	-
13	MOFFMS (MS-relay off or MOFF)	Normal	Alarming	-
14	Stop after instantaneous power off	-	Dec., Under stop	Refer to F 302 value
15	Stop after LL continuance time	-	Dec., Under stop	Refer to F 256 value

VF-AS3

bit	Function	0	1	Panel display
0	Over-current alarm	Normal	Alarming	[C] flicking
1	Inverter over load alarm	Normal	Alarming	[L] flicking
2	Motor over load alarm	Normal	Alarming	[L] flicking
3	Overheat alarm	Normal	Alarming	[H] flicking
4	Overvoltage alarm	Normal	Alarming	[P] flicking
5	(Undefined)	-	-	-
6	Inverter overheat alarm	Normal	Alarming	[L] flicking
7	Undercurrent alarm	Normal	Alarming	-
8	Over-torque alarm	Normal	Alarming	-
9	Braking resistor overload alarm	Normal	Alarming	-
10	Cumulative run time alarm	Normal	Alarming	-
11	Communication option alarm	Normal	Alarming	[E] flicking
12	Serial communication alarm	Normal	Alarming	[E] flicking
13	Power circuit under voltage alarm	Normal	Alarming	[MOFF] flicking
14	Stop after instantaneous power off	-	Dec., Under stop	[STOP] flicking
15	During sleep	-	Dec., Under stop	[STOP] flicking

7.1.20. *F d06* : 0x2D06 (Input TB Status)

VF-S15/MB1

bit	TB Name	Function (Parameter)	0	1
0	F	Input terminal function selection 1 (<i>F 111</i>)	OFF	ON
1	R	Input terminal function selection 2 (<i>F 112</i>)		
2	RES	Input terminal function selection 3 (<i>F 113</i>)		
3	S1	Input terminal function selection 4 (<i>F 114</i>)		
4	S2	Input terminal function selection 5 (<i>F 115</i>)		
5	S3	Input terminal function selection 6 (<i>F 116</i>)		
6	VIB*1	Input terminal function selection 7 (<i>F 117</i>)		
7	VIA*1	Input terminal function selection 8 (<i>F 118</i>)		
5 to 15	(Undefined)	-	-	-

Note: The bit described "Undefined" is unstable. Do not use the bit for the judgment.

*1: VIA/ VIB are input terminal function when *F 109* is logic input.

*The input terminal function is selected by each parameter.

VF-AS3

bit	TB Name	Function (Parameter)	0	1
0	F	<i>F 111</i> : Input terminal function selection 1	OFF	ON
1	R	<i>F 112</i> : Input terminal function selection 2		
2	RES	<i>F 113</i> : Input terminal function selection 3		
3	S1	<i>F 114</i> : Input terminal function selection 4		
4	S2	<i>F 115</i> : Input terminal function selection 5		
5	S3	<i>F 116</i> : Input terminal function selection 6		
6	S4*1	<i>F 117</i> : Input terminal function selection 7		
7	S5*2	<i>F 118</i> : Input terminal function selection 8		
8	DI11*3	<i>F 119</i> : Input terminal function selection 9		
9	DI12*3	<i>F 120</i> : Input terminal function selection 10		
10	DI13*3	<i>F 121</i> : Input terminal function selection 11		
11	DI14*3	<i>F 122</i> : Input terminal function selection 12		
12	DI15*3	<i>F 123</i> : Input terminal function selection 13		
13	DI16*3	<i>F 124</i> : Input terminal function selection 14		
14 to 15	(Undefined)	-	-	-

Note: The bit described "Undefined" is unstable. Do not use the bit for the judgment.

*1: Only when the contact input has been selected with *F 147* (Digital/ Pulse train/PG input), it is an effective value.

*2: Only when the contact input has been selected with *F 148* (Digital/ Pulse train/PG input), it is an effective value.

*3: DI11 – DI16 are the terminals of I/O extension.

7.1.21. F_{d07} : 0x2D07 (Output TB Status)

VF-S15/MB1

bit	TB Name	Function (Parameter)	0	1
0	RY-RC	Output terminal function selection 1A (F 130)	OFF	ON
1	OUT	Output TB Function select 2A (F 131)	OFF	ON
2	FL	Output TB Function select 3 (F 132)	OFF	ON
3 - 15	(Undefined)	-	-	-

Note: The bit described "Undefined" is unstable. Do not use the bit for the judgment.

VF-AS3

bit	TB Name	Function (Parameter)	0	1
0	FP	F 130: Terminal FP function 1	OFF	ON
1	(Undefined)	-	-	-
2	FL	F 132: Terminal FL function	OFF	ON
3	R1	F 133: Terminal R1 function 1	OFF	ON
4	R2	F 134: Terminal R2 function	OFF	ON
5	DQ11* ¹	F 159: Terminal DQ11 function	OFF	ON
6	DQ12* ¹	F 160: Terminal DQ12 function	OFF	ON
7	R4* ¹	F 161: Terminal R4 function	OFF	ON
8	R5* ¹	F 162: Terminal R5 function	OFF	ON
9	R6* ¹	F 163: Terminal R6 function	OFF	ON
10	R4(B)* ¹	A201: Terminal R4 (B) function	OFF	ON
11	R5(B)* ¹	A202: Terminal R5 (B) function	OFF	ON
12	R6(B)* ¹	A203: Terminal R6 (B) function	OFF	ON
13 to 15	(Undefined)	-	-	-

Note: The bit described "Undefined" is unstable. Do not use the bit for the judgment.

*1: DQ11, DQ12, R4, R5, R6, R4(B), R5(B) and R6(B) are the terminal of I/O extension.

8. Running by CiA402 drive profile

In this chapter, it is described how to control the drive by CiA402 (IEC61800-7) drive profile. On CiA402 drive profile, Controlword (0x6040) and vl_target_velocity (0x6042) are used as drive command. When CiA402 drive profile is used, TOSHIBA drive profile (communication command 1 (0x2A06) and communication command 2 (0x2A23) and frequency command (0x2A07) etc.) can't be used at the same time. However, for monitor or parameter read, TOSHIBA drive profile can be used.

8.1. CiA 402 drive profile

The control or monitor of drive can be operated by CiA402 drive profile. See the following procedure example about the usage.

1. Set 4: Communication option to command mode selection (*CMD*) and Set 7: communication option to frequency setting mode selection 1 (*FREQ*).
Note) In case the drive is VF-AS3, *CMD* is set to 5 and *FREQ* is set to 23.
2. Set to Controlword (0x6040) and vl_target_velocity (0x6042) to RPDO.
See 6.1.1 about mapping.
Set the number of motor pole to *F555*. Note) It needs to set only one time at first setting.
3. Set to the parameter of CiA402 for running (the values in brackets are the CANopen addresses of the parameter).
4. Set 0x06 to Controlword (0x6040). Set 0x07 to Controlword (0x6040). Set 0x0F to Controlword (0x6040). After that, CiA402 status is changed to operation enabled.
See "8.1.3.CiA402 State Chart".
5. Set 1500min⁻¹ to vl_target_velocity (0x6042). As the result, the drive is running at 50Hz.

Control diagram:

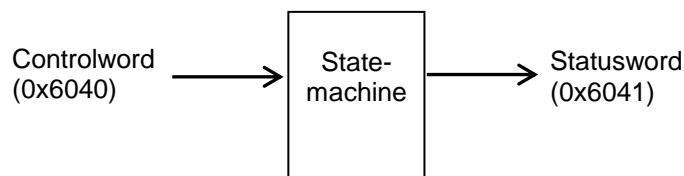

Simplified diagram of speed control in "Velocity" mode:

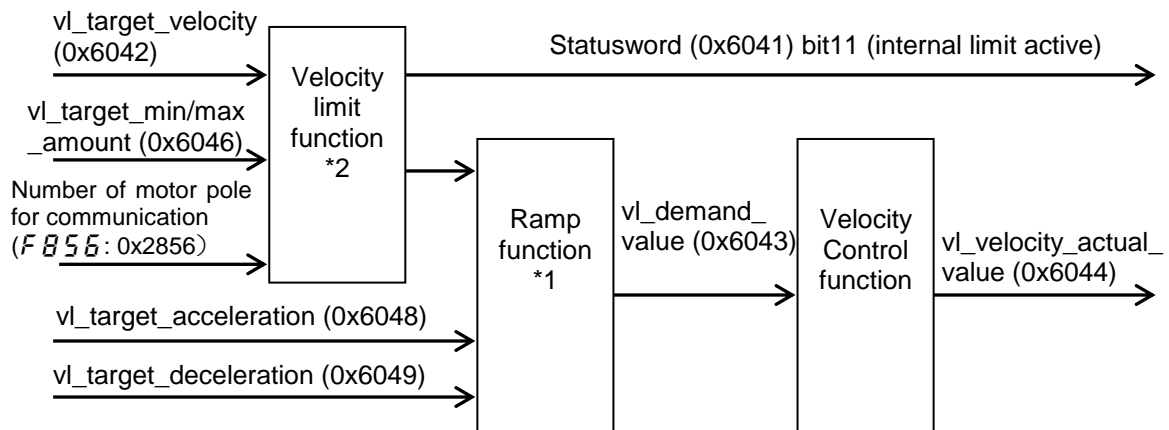

*1: Do not change the acceleration/deceleration time unit (parameter *F519*), if change the parameter, the setting value range will be different from above range.

In this case, set 0(Linear) to acceleration/deceleration 1 pattern (*F502*: 0x2502). (S-p altern isn't supported.)

*2: Set Maximum frequency (*FH*) to the right max value. See "8.1.8" for the detailed information.

8.1.1. Object 0x6040: Controlword

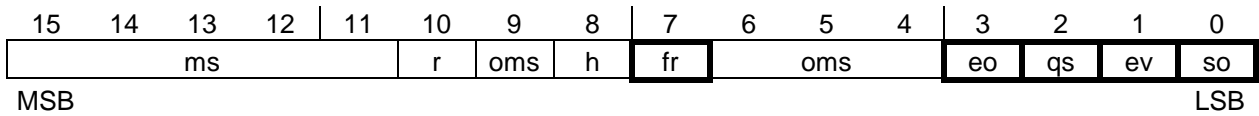

- ms = manufacturer-specific
(bit11: 0 = Forward direction asked, 1 = Reverse direction asked)
- r = reserved
- oms = operation mode specific
- h = halt
- fr = fault reset
- eo = enable operation
- qs = quick stop
- ev = enable voltage
- so = switch on

8.1.2. Object 6041: Statusword

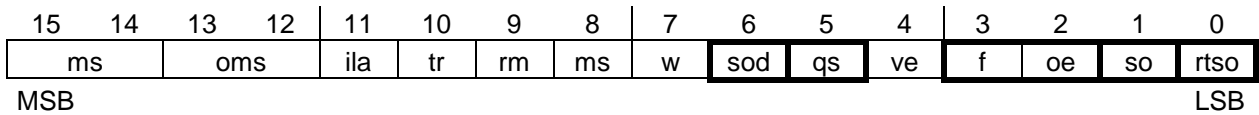

- ms = manufacturer-specific
- oms = operation mode specific
- ila = internal limit active
- tr = target reached
- rm = remote
- w = warning
- sod = switch on disabled
- qs = quick stop
- ve = voltage enabled
- f = fault
- oe = operation enabled
- so = switched on
- rtso = ready to switch on

Status	bit 6	bit 5	bit 4	bit 3	bit 2	bit 1	bit 0	Status Word
	Switch on disabled	Quick stop	Voltage enabled	Fault	Operation enabled	Switched on	Ready to switch on	
1 - Not ready to switch on	0	×	×	0	0	0	0	-
2 - Switch on disabled	1	×	×	0	0	0	0	-
3 - Ready to switch on	0	1	×	0	0	0	1	-
4 - Switched on	0	1	1	0	0	1	1	0x0033
5 - Operation enabled	0	1	1	0	1	1	1	0x0037
Status	bit 6	bit 5	bit 4	bit 3	bit 2	bit 1	bit 0	Status Word
	Switch on disabled	Quick stop	Voltage enabled	Fault	Operation enabled	Switched on	Ready to switch on	
6 - Quick stop active	0	0	1	0	1	1	1	0x0017
7 - Fault reaction active	0	×	×	1	1	1	1	-
8 - Fault	0	×	×	1	0	0	0	*0x0008 or 0x0028

×: In this state, the value of the bit can be 0 or 1.

*Detected fault following state "6 - Quick stop active".

8.1.3. CiA402 State Chart

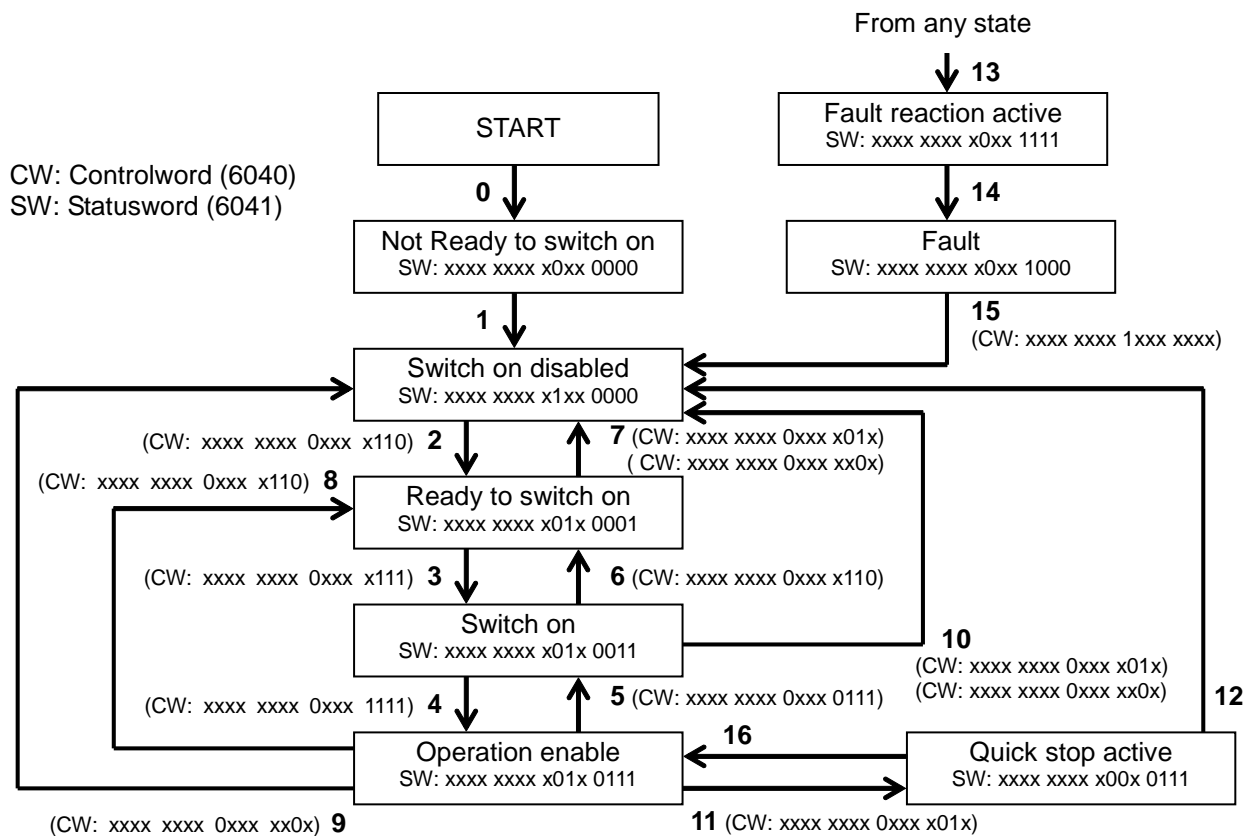

Command coding (IEC 61800-7-200/Ed.1.0 Table 27)

Command	Bits of the controlword					Transitions
	fault reset	enable operation	Quick stop	enable voltage	switch on	
	Bit 7	Bit 3	Bit 2	Bit 1	Bit 0	
Shutdown	0	x	1	1	0	2, 6, 8
Switch on	0	0	1	1	1	3
Switch on + enable operation	0	1	1	1	1	3 + 4 Note
Disable voltage	0	x	x	0	x	7, 9, 10, 12
Quick stop	0	x	0	1	x	7, 10, 11
Disable operation	0	0	1	1	1	5
Enable operation	0	1	1	1	1	4, 16
Fault reset	↑	x	x	x	x	15

NOTE Automatic transition to Enable operation state after executing SWITCHED ON state functionality. When detects main power loss or not release main power loss in 3 sec after change to "Switch on state", the state is changed to "Switch on disable".

8.1.4. Information of CiA402 State

Description of States

Each state represents an internal reaction by the drive.

This chart will change depending on whether the control word is sent "CMD" or an event occurs (a detected fault, for example).

The drive state can be identified by the value of the status word "ETA."

State	Drive internal reaction
1- Not Ready to switch on	Initialization stats. This is a transient state invisible to the communication network.
2 - Switch on disable	The drive is inactive. The drive is locked, no power is supplied to the motor.
3 – Ready to switched on	The drive is supplied with AC power but is stationary. The drive is locked, no power is supplied to the motor.
4 - Switched on	The drive is supplied with AC power but is stationary. The drive is locked, no power is supplied to the motor. The power stage of the drive is ready to operate, but voltage has not yet been applied to the output.
5 - Operation enabled	The drive is running. The drive is unlocked, power is supplied to the motor. The drive functions are activated and voltage is applied to the motor terminals. If the reference is zero or the "Halt" command is applied, no power is supplied to the motor when the output frequency is zero. But, the drive is running the case of "DC braking" or "Motor shaft fixing control" or "Auto turning" although the output frequency is zero. NOTE: The command "4 - Enable operation" must be taken into consideration only if the channel is valid. In particular, if the channel is involved in the command and the reference, transition 4 will take place only after the reference has been received for the first time.
6 - Quick stop active	Emergency stop. The drive performs a fast stop, after which restarting will only be possible once the drive has changed to the "Switch on disabled" state. During fast stop, the drive is unlocked and power is supplied to the motor. The condition for transition 12 to state "2 - Switch on disabled" depends on the value of the parameter "Quick stop mode": If the "Quick stop mode" parameter has the value 0, the drive stops freewheel and then changes to state "2 - Switch on disabled". If the "Quick stop mode" parameter has the value 1, the drive stops according to the slow down ramp and then changes to state "2 - Switch on disabled". If the "Quick stop mode" parameter has the value 2, the drive stops according to the quick stop ramp (0x604A) and the changes to state "2 - Switch on disabled". Do not set the value 3 to "Quick stop parameter". If the "Quick stop mode" parameter has the value 4, the drive stops according to the voltage limit and the changes to state "2 - Switch on disabled".

State	Drive internal reaction
7 - Fault reaction active	Transient state during which the drive performs an action appropriate to the type of detected fault. The drive function is activated or deactivated according to parameter <i>F603</i> when detected the emergency stop.
8 - Fault	Drive has detected a fault. The drive is locked, no power is supplied to the motor.

Summary

State	Power supplied to motor
1 - Not ready to switch on	No
2 - Switch on disabled	No
3 - Ready to switch on	No
4 - Switched on	No
5 - Operation enabled	Yes
6 - Quick stop active	Yes, during fast stop
7 - Fault reaction active	Depends on parameter <i>F603</i> when detected the emergency stop.
8 - Fault	No

8.1.5. Object 0x6042: vl_target_velocity

This object shall indicate the required velocity of the system. The value is given in revolutions per minute (min^{-1}). Positive values forward direction and negative values indicate reverse direction.

At changing to "Operation enable" state, this target velocity is cleared. So set this target velocity data after changed the state to "Operation enable."

Warning



▼ This object value is depending on the *F856* parameter and confirms its setting value. The motor rotational speed of the forecast is not obtained when the setting is mistaken, and there is danger of causing the accident etc.

8.1.6. Object 0x6043: vl_velocity_demand

This object provides the instantaneous velocity generated by the ramp function. It is an internal object of the drive device. The value is given same unit as the vl_target_velocity. Positive values indicate forward direction and negative values indicate direction.

8.1.7. Object 0x6044: vl_velocity_actual_value

This object provides the velocity at the motor spindle or load. Depending on the implementation (simple drive device, without sensor, etc.), the drive provides the appropriate image of the actual velocity (velocity demand, velocity control effort, calculated velocity).

The value is given in the same unit as the vl_target_velocity. A positive value indicates forward direction and negative values indicate reverse direction.

8.1.8. Object 0x6046: vl_velocity_min_max_amount

This object indicates The vl_velocity_max amount sub-object is mapped internally to the vl_velocity_max positive and vl_velocity_max negative values. The vl_velocity_min positive and vl_velocity_min negative values.

At initial configuration, the vl_velocity_max value is 1500min^{-1} and vl_velocity_min value is 0min^{-1} . Set the value of Object 0x6046 if the value is enough.

Then, max value of speed is limited by Maximum frequency (*FH*). Set *FH* to the right value.

<example>

Motor pole number for communication (*F856*) = 2: 4 pole

Max value of speed = 3000min^{-1}

Maximum frequency (*FH*) = $4 * 3000 / 120 = 100\text{Hz}$

In the result, set *FH* to 100Hz.

8.1.9. Object 0x6048: vl_velocity_acceleration

This object indicates the configured delta speed and delta time of the slope of the acceleration ramp.

VF-MB1/S15

Velocity Acceleration Delta Speed : 225 to 30,000 min⁻¹

Velocity Acceleration Delta Time : 1 to 3,600 s

VF-AS3

Velocity Acceleration Delta Speed : 225 to 32,700 min⁻¹

Velocity Acceleration Delta Time : 1 to 6,000 s

Note: Do not change the acceleration/deceleration time unit (parameter *F519*), if change the parameter, the setting value range will be different from above range. In this case, set 0(Linear) to acceleration/deceleration 1 pattern (*F502*: 0x2502). (S-pattern isn't supported.)

8.1.10. Object 0x6049: vl_velocity_deceleration

This object indicates the configured delta speed and delta time of the slope of the deceleration ramp.

VF-MB1/S15

Velocity Deceleration Delta Speed : 225 to 30,000 min⁻¹

Velocity Deceleration Delta Time : 1 to 3,600 s

VF-AS3

Velocity Deceleration Delta Speed : 225 to 32,700 min⁻¹

Velocity Deceleration Delta Time : 1 to 6,000 s

Note: Do not change the acceleration/deceleration time unit (parameter *F519*), if change the parameter, the setting value range will be different from above range. In this case, set 0(Linear) to acceleration/deceleration 1 pattern (*F502*: 0x2502). (S-pattern isn't supported.)

8.1.11. Object 0x604A: vl_velocity_quick_stop

This object indicates the configured delta speed and delta time of the slope of the deceleration ramp for quick stop.

VF-MB1/S15

Velocity Deceleration Delta Speed : 225 to 30,000 min⁻¹

Velocity Deceleration Delta Time : 1 to 3,600 s

VF-AS3

Velocity Deceleration Delta Speed : 225 to 32,700 min⁻¹

Velocity Deceleration Delta Time : 1 to 6,000 s

Note: Do not change the acceleration/deceleration time unit (parameter *F519*), if change the parameter, the setting value range will be different from above range.

8.1.12. Object 0x605A: Quick stop option code

This object shall indicate what action is performed when the quick stop function is executed.

The slow down ramp is the deceleration value of the used mode of operations.

Value	Definition
-32768 to -1	No function
0	Disable drive function
+1	Slow down on slow down ramp and transit into Switch On Disabled
+2	Slow down on quick stop ramp and transit into Switch On Disabled
+3	Do not set
+4	Slow down on voltage limit and transit into Switch On Disabled
+5*	Slow down on slow down ramp and stay in Quick Stop Active
+6*	Slow down on quick stop ramp and stay in Quick Stop Active
+7*	Do not set
+8*	Slow down on voltage limit and stay in Quick Stop Active
+9 to +32 767	Reserved

*Not supported these values. Do not set these values. If set the value 5-8, the drive slow down ramp and transit into Switch On Disabled.

8.1.13. Object 0x6060: Mode of operation

The object shall indicate the requested operation mode.
 This module supports the “vl (= 2)” (velocity mode) only.

NOTE: This object shows only the value of the requested operation mode, the actual operation mode of the PDS* is reflected in the object modes of operation display.

*PDS: Power drive system

Value	Definition
-128 to -1	Manufacturer-specific operation modes
0	No mode change/no mode assigned
+1	Profile position mode
+2	Velocity mode
+3	Profile velocity mode
+4	Torque profile mode
+5	Reserved
+6	Homing mode
+7	Interpolated position mode
+8	Cyclic sync position mode
+9	Cyclic sync velocity mode
+10	Cyclic sync torque mode
+11 to +127	Reserved

8.1.14. Object 0x6061: Mode of operation display

This object shall provide the actual operation mode.
 This module supports the “vl (= 2)” (velocity mode) only.

8.1.15. Object 0x6502: Supported drive mode

This object shall provide information on the supported drive modes.
 This module supports the “vl (= 2)” (velocity mode) only.

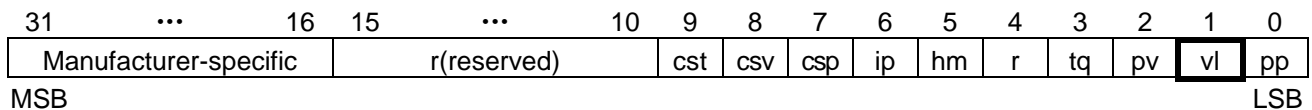

8.1.16. Object 603F: Error Code

Below table describes the relations of the error code and drive error.

Error code	Meaning	Drive error code	Drive error name	Drive condition
0x0000	No error	0x00	---	---
0x1000	Generic error	0x0E	<i>OL 2</i>	Motor overload
		0x15	<i>Err 2</i>	Main unit RAM fault
		0x16	<i>Err 3</i>	Main unit ROM fault
		0x17	<i>Err 4</i>	CPU fault 1
		0x19	<i>Err 6</i>	Gate array fault [VF-AS3] *1
		0x1A	<i>Err 7</i>	Current detector fault
		0x1C	<i>Err 9</i>	Remote keypad disconnection fault
		0x24	<i>OCr</i>	Overcurrent (Braking resistor) [VF-AS3] *1
		0x28	<i>Errn</i>	Auto-tuning error
		0x2B	<i>E-11</i>	Brake answer error [VF-AS3] *1
		0x2C	<i>E-12</i>	PG error
		0x35	<i>E-21</i>	CPU fault 2
		0x38	<i>E-24</i>	Option fault (slot B) [VF-AS3] *1
		0x39	<i>E-25</i>	Option fault (slot C) [VF-AS3] *1
		0x3A	<i>E-26</i>	CPU fault 3
		0x3C	<i>Ut</i>	Undertorque [VF-AS3] *1
		0x3D	<i>E-29</i>	Control power option failure [VF-AS3] *1
0x3F	<i>E-31</i>	Rush current suppression relay fault [VF-AS3] *1		
0x55	<i>Errn2</i>	Auto-tuning error		
0x56	<i>Errn3</i>	Auto-tuning error		
0x2230	Short circuit/earth leakage (device internal)	0x05	<i>OCRA</i> <i>OCRA1</i>	Short circuit in arm [VF-MB1/S15] Overcurrent (U-phase arm) [VF-AS3] *1
		0x06	<i>OCRA2</i>	Overcurrent (V-phase arm) [VF-AS3] *1
		0x07	<i>OCRA3</i>	Overcurrent (W-phase arm) [VF-AS3] *1
0x2310	Continuous over current	0x01	<i>OC1</i>	Overcurrent during acceleration
		0x02	<i>OC2</i>	Overcurrent during deceleration
		0x03	<i>OC3</i>	Overcurrent during constant speed operation
0x2311	Continuous over-current No. 1	0x20	<i>Ot</i>	Over-torque trip 1
		0x41	<i>Ot2</i>	Over-torque trip 2
		0x48	<i>Otc3</i>	Over-torque / Overcurrent fault
0x2320	Short circuit/earth leakage (motor-side)	0x04	<i>OCL</i>	Overcurrent (An overcurrent on the load side at start-up)
0x2330	Earth leakage	0x22	<i>EF2</i>	Ground fault
0x3110	Mains over-voltage	0x0A	<i>OP1</i>	Overvoltage during acceleration
		0x0B	<i>OP2</i>	Overvoltage during deceleration
		0x0C	<i>OP3</i>	Overvoltage during constant speed operation
0x3120	Mains under-voltage	0x1E	<i>UP1</i>	Undervoltage fault (main circuit)
0x3130	Phase failure	0x08	<i>EPH1</i>	Ground fault

0x3310	Output over-voltage	0x09	<i>EPHO</i>	Output phase failure
		0x0F	<i>OLr</i>	Dynamic braking resistor overload trip
		0x47	<i>E-39</i>	Auto-tuning error (PM motor)
0x4130	Ambient temperature	0x4A	<i>E-42</i>	Cooling fan fault [VF-AS3] *1
0x4210	Excess temperature device	0x0D	<i>OLI</i>	Inverter overload
		0x10	<i>OH</i>	Overheat
		0x3E	<i>OL3</i>	Main module overload
0x5140	Battery failure	0x4C	<i>E-44</i>	Battery of panel failure [VF-AS3] *1
0x5500	Unit internal fault	0x50	<i>E-48</i>	A6 Brake Unit internal fault [VF-AS3] *1
0x5530	Control EEPROM failure	0x12	<i>EEP1</i>	EEPROM fault 1
		0x13	<i>EEP2</i>	EEPROM fault 2
		0x14	<i>EEP3</i>	EEPROM fault 3
		0x29	<i>EtYP</i>	Inverter type error
0x6100	Internal software	0x33	<i>E-19</i>	CPU communication error
		0x37	<i>E-23</i>	Optional unit fault 2 [VFMB1/S15], Option fault (slot A) [VF-AS3]
0x7300	Sensor	0x2E	<i>OH2</i>	Thermal fault stop command from external device
		0x32	<i>E-18</i>	Analog input break detection fault
		0x40	<i>E-32</i>	PTC fault
0x7310	Speed	0x2D	<i>E-13</i>	Over speed fault
0x7500	External communication fault	0x36	<i>E-22</i>	Embedded Ethernet fault [VF-AS3] *1
		0x46	<i>E-38</i>	Communication time-out of A6 Brake Unit
		0x4b	<i>E-43</i>	Communication time-out (embedded Ethernet) [VF-AS3] *1
0x7510	Serial interface No. 1	0x18	<i>E-r-5</i>	Communication error
0x7520	Serial interface No. 2	0x1B	<i>E-r-8</i>	Optional unit fault 1
0x8331	Torque fault	0x2F	<i>SOULt</i>	Step-out (for PM motor drive only)
		0x34	<i>E-20</i>	Over torque boost fault
0x8501	Servo lock failure	0x45	<i>E-37</i>	Servo lock fault
0x9000	External malfunction	0x11	<i>E</i>	Emergency stop
		0x58	<i>E-99</i>	Trip for test [VF-AS3] *1
0xFF00	Additional functions - generic error	0x54	<i>Et n 1</i>	Auto-tuning error
		004D	<i>E-45</i>	GD2 auto-tuning error
0xFF03	Device specific - generic error	0x1D	<i>UL</i>	Low-current operation Trip
		0x3B	<i>P-r-F</i>	Safe torque switching check alarm
		0x49	<i>ULt3</i>	Undertorque / Undercurrent [VF-AS3] *1
		0x57	<i>E-27</i>	Power removal fault [Only VF-S15]

*1: These errors are for VF-AS3.

9. EtherCAT State Machine (ESM)

ESM Diagram

The EtherCAT State machine coordinates the master and slave applications at start up and during operation. State changes are typically initiated requests of the master. They are acknowledged by the local application after the associated operations have been executed.

Description of the state management

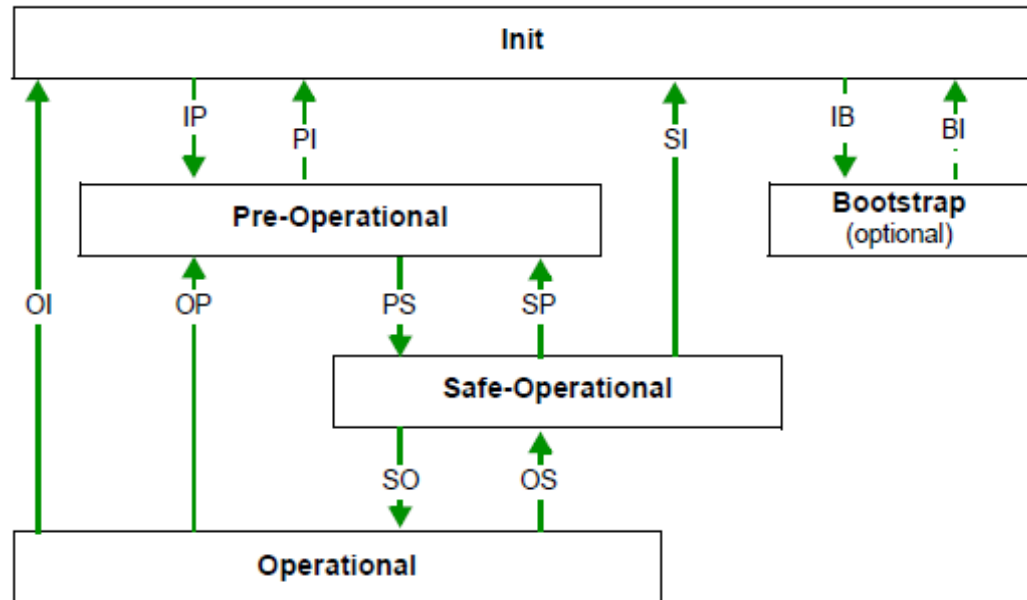

ESM states

The state **Init** defines the foundation of the communication relationship between the master and the slaves at the application layer. Direct communication between the master and the slave is impossible at the application layer. The master uses the **Init** state to initialize a set of configuration registers of the EtherCAT slave controllers. If the slaves support mailbox services is configured in this state.

In the **Pre-Operational** state, the mailbox is active. Both master and slave use the mailbox and the corresponding protocol to interchange application-specific initialization data and parameters. In this state, process data communication is not possible.

If the drive does not receive a valid mapping for the process data from the EtherCAT master, it remains in this state.

In the **Safe-Operational** state, the slave application provides current input data such as limit switch data.

Output data of the master are ignored in this state. This is not a safety function.

In the state **Operational**, the slave applications deliver current input data and the drive processes the current output data from the drive, such as target velocity.

State transitions

State transition	Local management service	Value
IP	Start Mailbox Communication	0x02
PI	Stop Mailbox Communication	0x01
PS	Start Input Update	0x04
SP	Stop Input Update	0x02
SO	Start Output Update	0x08
OS	Stop Output Update	0x04
OP	Stop Output Update and Stop Input Update	0x02
SI	Stop Input Update, Stop Mailbox Communication	0x01
OI	Stop Input Update, Stop Mailbox Communication	0x01
IB	Start Bootstrap Mode, redirection to (BI)	0x03
BI	Restart Device	0x01

ESM states management

The ESM states are managed with the library: TC EtherCAT lib. See the example, step 15 page 65.

ESM states and communication interruptions

The ESM states are managed with the library: TC EtherCAT lib. See the example, step 15 page 65.

Some transitions in the ESM state chart will trigger a communication interruption.

These transitions suppress a service, which can be used to control the drive.

A detected fault is triggered in order to avoid losing control of the drive (only if the drive is running).

State transition	Service lost
PI	SDO
SI	SDO, TPDO
SP	TPDO
OS	RPDO
OP	PDO
OI	SDO, PDO

Depending on the communication status of the drive, the following services are available:

	Init	Pre-operational	Safe-Operational	Operational
PDO	No response	No response	TPDO, inputs only active, no outputs to drive active	active
SDO	No response	active	active	active

10. Example:VF-MB1 with TwinCAT® “PLC-Configuration”

This example shows a combination of VF-MB1 and TwinCAT®.
When you use VF-S15/AS3, please read MB1 as S15/AS3.

10.1. Hardware

Connect your computer and the IPE003Z with a standard Cat 5e cable (2 x RJ45, shielded twisted pair cable).

10.2. TwinCAT® software installation

Install the TwinCAT® software to PC. This example is shown with TwinCAT® software version 2.11.

Note: The screenshots or procedure in this example will be changed with a new TwinCAT®

There are ESI files for VF-MB1/S15/AS3.
Filename: TOSVERT_VFxx.xml

Copy this XML file on your computer in C:\TwinCAT\Io\EtherCAT.

Note) The drive name for each product exist only one on TwinCAT®. If the software is updated, delete the old ESI file and copy to the new ESI to the folder. If the old and new ESI are need, select the right file. See “1.Product version and ESI file” to select it.

10.3. ESI file (EtherCAT Slave Information)

You can use the ESI file in XML format for VF-MB1/S15/AS3. See “1.Product version and ESI file” to select the file.

The ESI file must be integrated into the system on the master controller.
For example (directory pass): C:\TwinCAT\Io\EtherCAT

As for acquisition of the ESI file, please contact your Toshiba distributor.

10.4. VF-MB1 configuration

Set the configuration parameter when the Drive is controlled by CiA402 drive profile.

VF-MB1/S15

Set *CnQd* to 4 and *FnQd* to 7 and controlled with 0x6040 and 0x6041 objects.

VF-AS3

Set *CnQd* to 5 and *FnQd* to 23 and controlled with 0x6040 and 0x6041 objects.

10.5. System Manager: Declare your computer on Ethernet network

Start TwinCAT® system-manager®  TwinCAT System Manager

Select Options -> “Show Real Time Ethernet Compatible devices”

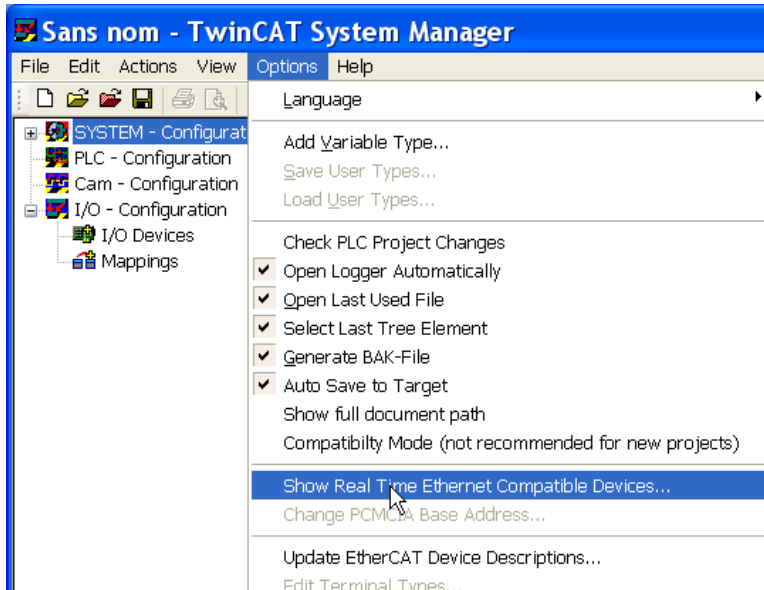

① Select your Computer Ethernet board, and “Install”.

② Enable it.

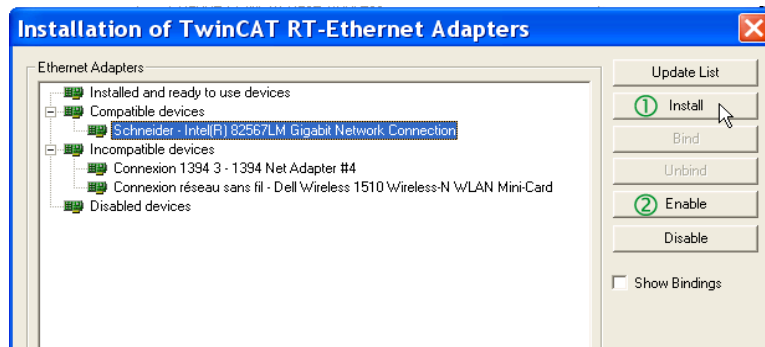

10.6. System Manager: Install the master

In this example we use the computer to run TwinCAT® and PLC runtime as Mater.

- ① Select "Choose Target"
- ② Select "Search (Ethernet)"

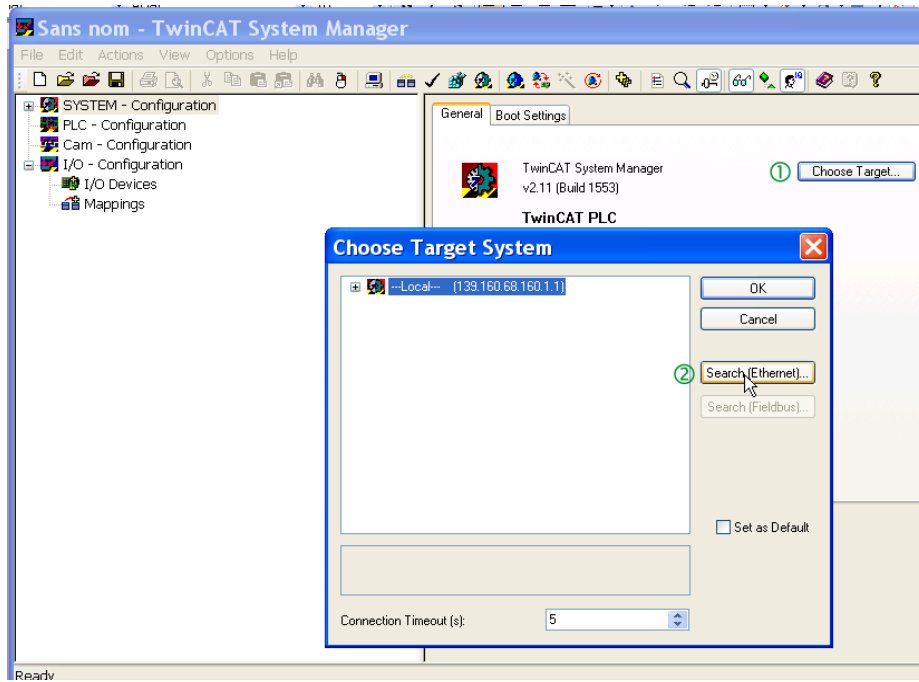

- ③ Start the "Broadcast Search"
- ④ Select your Master in the Host Name list (your computer in this example)

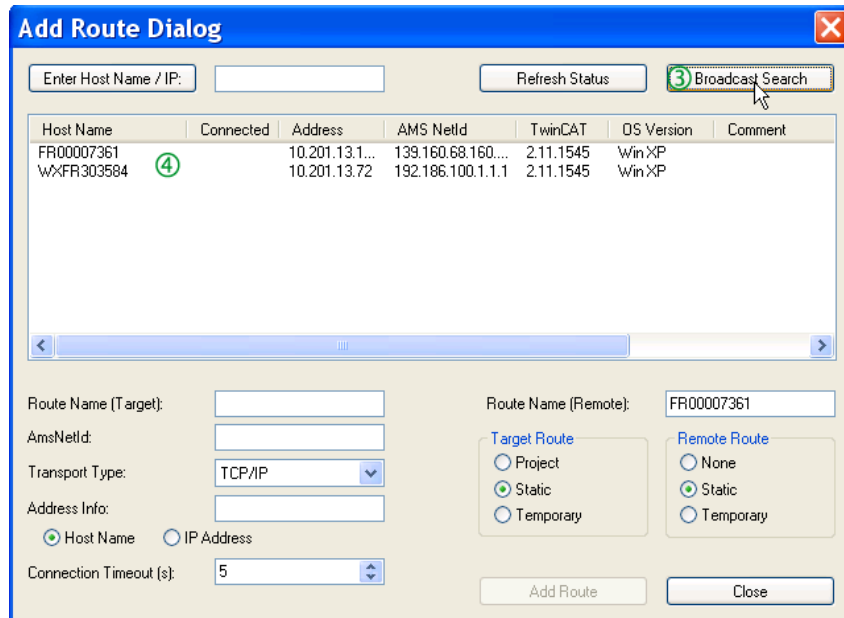

⑤ Check that you are in “config mode”

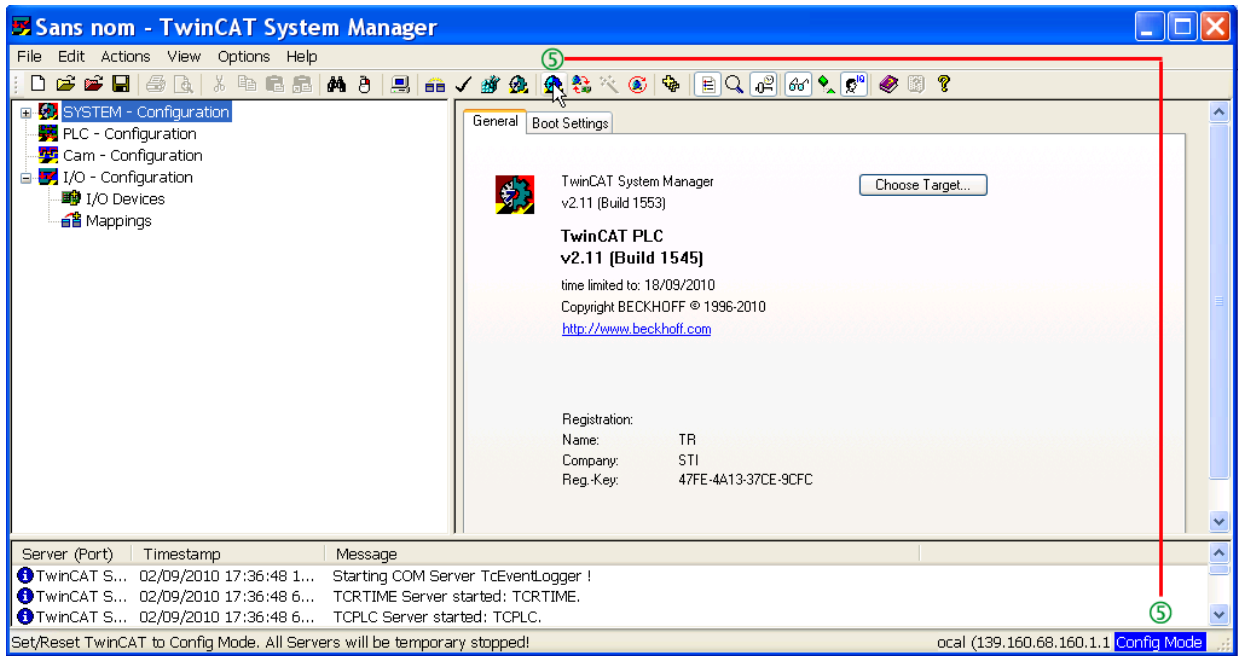

10.7. System Manager – Install the slave: MB1 in “PLC- configuration”

① Select the I/O Devices -> Scan Devices

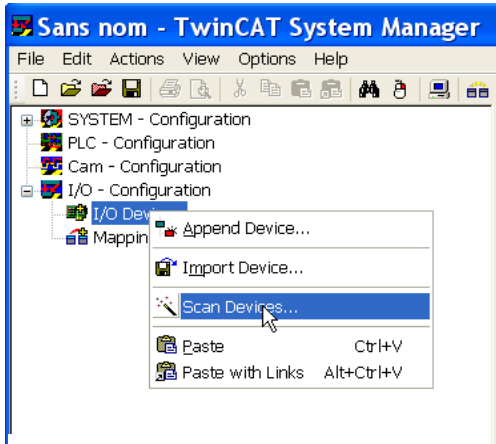

② Choose the “OK.”

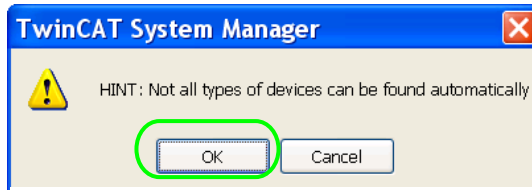

③ Check the “Device 1[EtherCAT]” -> Choose the “OK.”

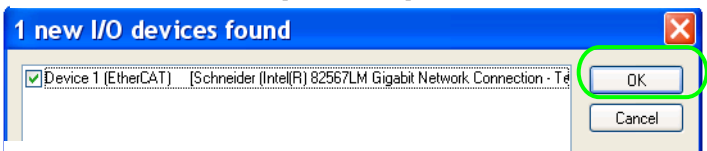

④ Choose the “Yes”.

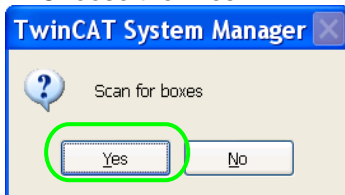

⑤ Choose the “Yes.”

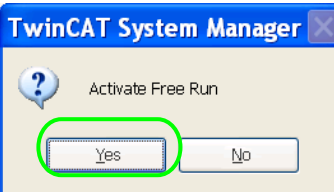

⑥ Shows the boxes and activates Free Run.

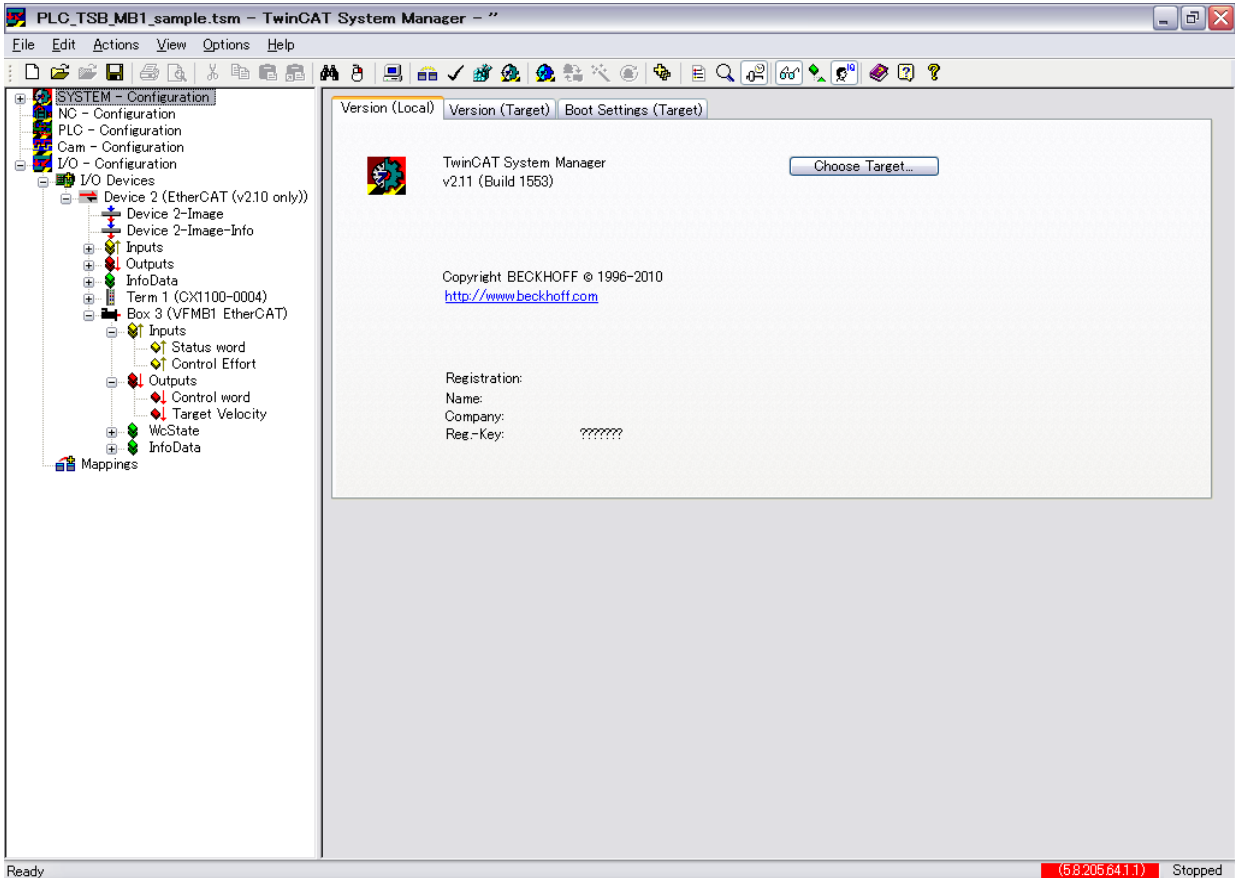

10.8. PLC – Control: initialization

- ① Start TwinCAT PLC control® software  TwinCAT PLC Control
- ② File -> new

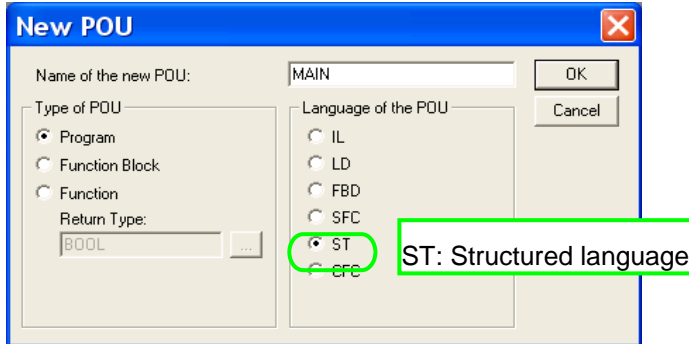
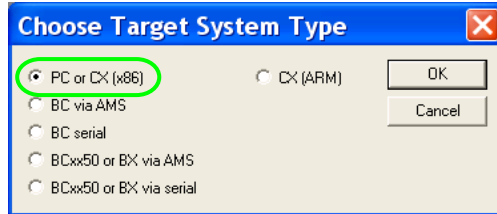

- ③ Select; Resources -> Library Manager
- ④ Add EtherCAT libraries

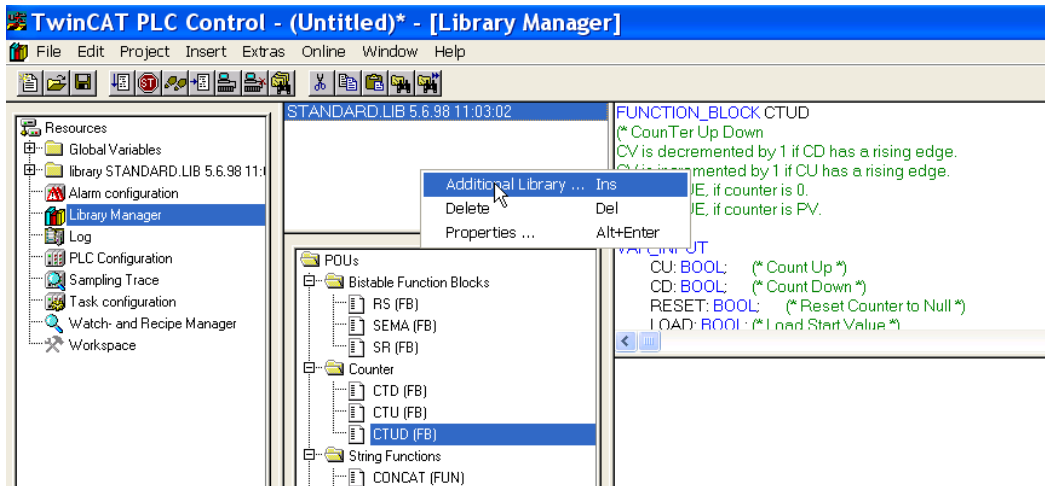

⑤ Add TcEtherCAT.lib

⑥ All EtherCAT libraries are added:

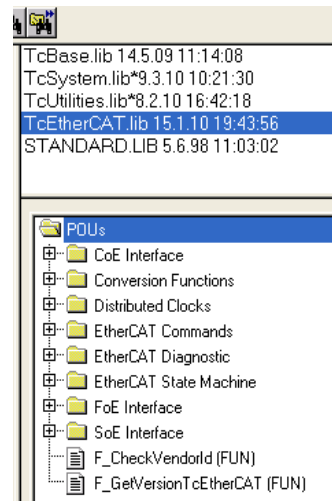
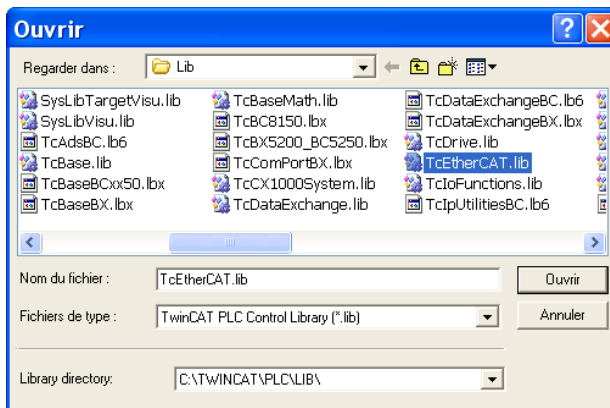

10.9. PLC – Control: Declare the variables

① Select Global_Variables

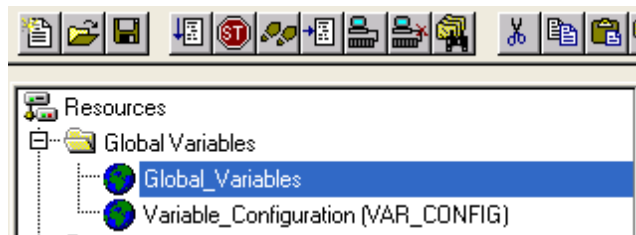

② Create the Master Global_Variables for MB1 as below. Copy/paste the variables:

VAR_GLOBAL

```

MB1_State AT %I*:WORD;
PLC_state AT %I*:UINT;
MB1_TPDO_Input1_Status_Word AT %I*:WORD;
MB1_TPDO_Input2_Control_Effort AT %I*:WORD;
MB1_TPDO_Input3 AT %I*:WORD;
MB1_TPDO_Input4 AT %I*:WORD;
MB1_TPDO_Input5 AT %I*:WORD;
MB1_TPDO_Input6 AT %I*:WORD;
MB1_RPDO_Output1_Control_Word AT %Q*:WORD;
MB1_RPDO_Output2_Target_Velocity AT %Q*:WORD;
MB1_RPDO_Output3 AT %Q*:WORD;
MB1_RPDO_Output4 AT %Q*:WORD;
MB1_RPDO_Output5 AT %Q*:WORD;
MB1_RPDO_Output6 AT %Q*:WORD;

```

END_VAR

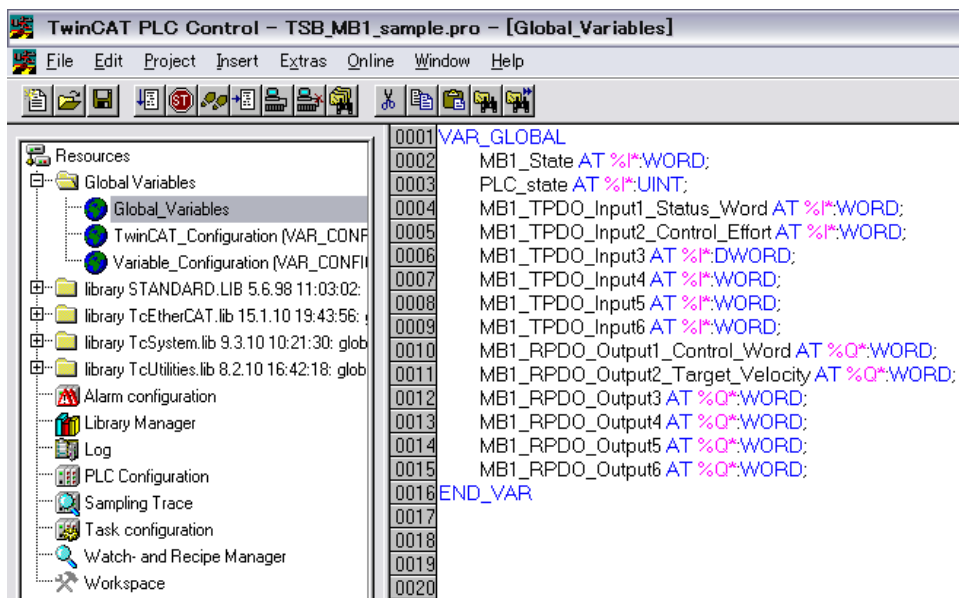

- RPDO (Receive PDO), containing 6 input words of the communication scanner. RPDO is set to index 0x1600 (sub-index 1 to 6).
- TPDO (Transmit PDO), containing 6 input words of the communication scanner. TPDO is set to index 0x1A00 (sub-index 1 to 6).

③Add 1 instruction minimum in POU's before rebuild;

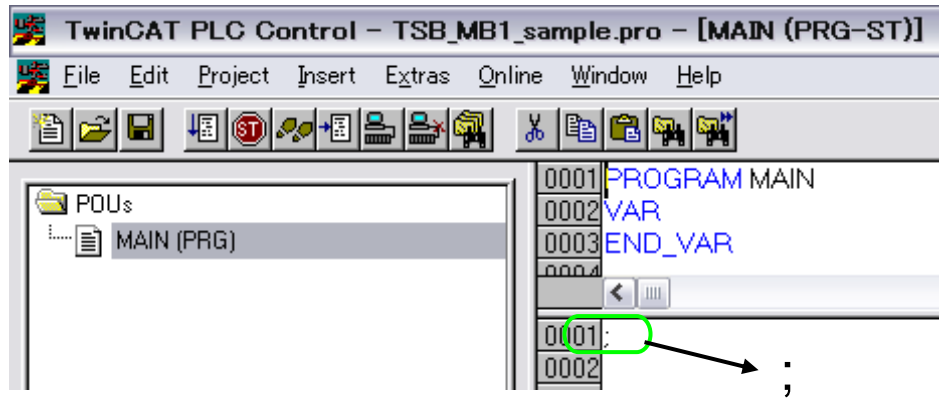

④Select: Project -> Rebuild All

⑤Check the compilation result without error.

⑥This action creates file in: C:\TwinCAT\Plc

As example, create: TSB_MB1_sample.tpy

10.10. System Manager – Append PLC Project

In System Manager software, realize the link between the Master and the slave. Creation of the links between “PLC – Configuration” and “I/O - Configuration”

①Select “Append PLC Project...”:

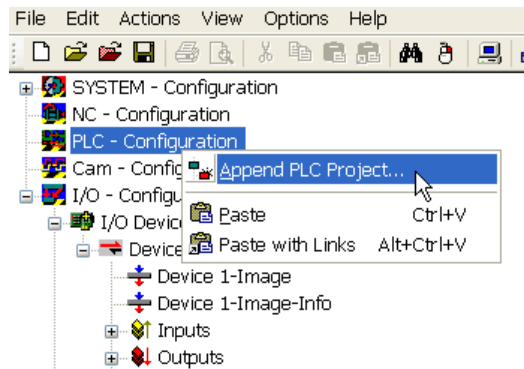

As example, select: C:\TwinCAT\Plc\TSB_MB1_sample.tpy

②For each parameter, create the link with the MB1/IO listing

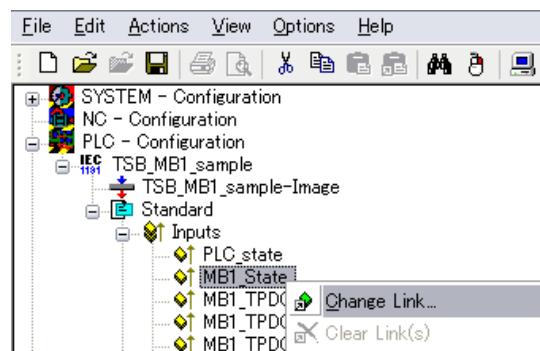

Example for “MB1_State”

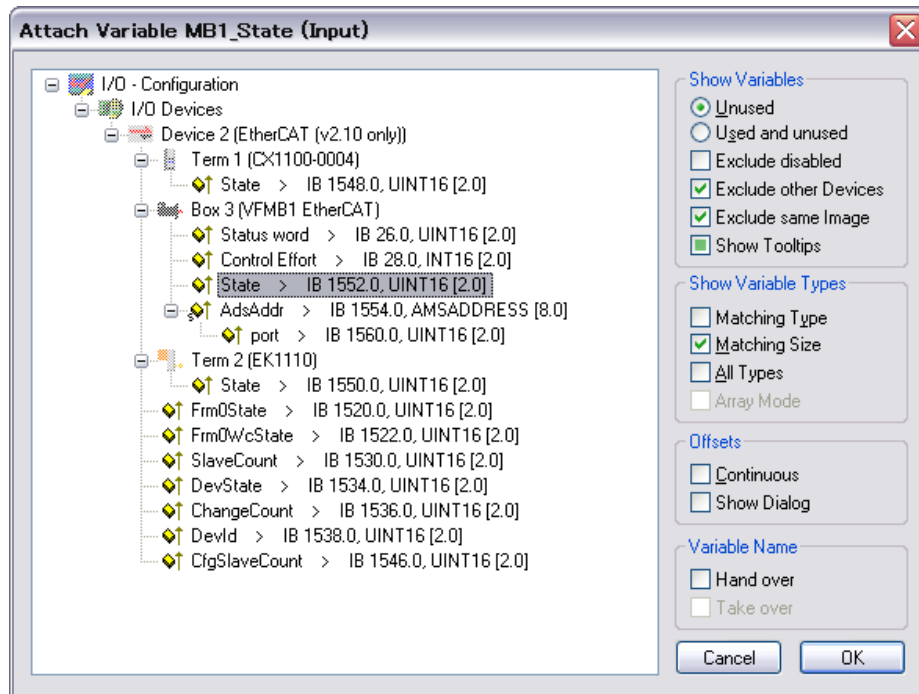

Links to create

PLC – Configuration		I/O - Configuration
Inputs	MB1_State	State
Inputs	PLC_State	DevState (with Device1)
Inputs	MB1_TPDO_input1_Status_Word	Status word
Inputs	MB1_TPDO_input2_Control_Effort	Control effort
Inputs	MB1_TPDO_input3	Available for other parameter
Inputs	MB1_TPDO_input4	Available for other parameter
Inputs	MB1_TPDO_input5	Available for other parameter
Inputs	MB1_TPDO_input6	Available for other parameter
Outputs	MB1_RPDO_Output1_Control_Word	Control word
Outputs	MB1_RPDO_Output2_Target_Velocity	Target Velocity
Outputs	MB1_RPDO_Output3	Available for other parameter
Outputs	MB1_RPDO_Output4	Available for other parameter
Outputs	MB1_RPDO_Output5	Available for other parameter
Outputs	MB1_RPDO_Output6	Available for other parameter

Note: if more than 6 input or output parameters are created in TwinCAT® System Manager, the MB1 will be blocked in “PreOp” State. The MB1 has maximum 6 TPDO and 6 RPDO.

③Select: Actions -> Generate Mappings.

10.11. PLC - Control: new compilation

Select: Project -> Rebuild All
This action updates the information.

10.12. System Manager: Activate configuration

Select: Actions -> Activate Configurations

10.13. PLC - Control: Run

①Select: Online -> login

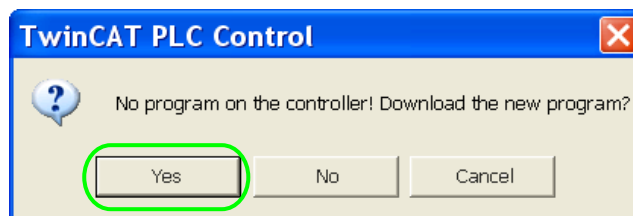

②Select: Online -> Run

The PLC and the EtherCAT fieldbus are now running.

In TwinCAT® PLC Control, you see the list of the variables and values:

0001	MB1_State (%IB0) = 16#0008
0002	PLC_state (%IB2) = 16#0000
0003	MB1_TPDO_Input1_Status_Word (%IB4) = 16#0237
0004	MB1_TPDO_Input2_Control_Effort (%IB6) = 16#0469
0005	MB1_TPDO_Input3 (%IB8) = 16#0000
0006	MB1_TPDO_Input4 (%IB10) = 16#0000
0007	MB1_TPDO_Input5 (%IB12) = 16#0000
0008	MB1_TPDO_Input6 (%IB14) = 16#0000
0009	MB1_RPDO_Output1_Control_Word (%QB0) = 16#000F
0010	MB1_RPDO_Output2_Target_Velocity (%QB2) = 16#0708
0011	MB1_RPDO_Output3 (%QB4) = 16#0000
0012	MB1_RPDO_Output4 (%QB6) = 16#0000
0013	MB1_RPDO_Output5 (%QB8) = 16#0000
0014	MB1_RPDO_Output6 (%QB10) = 16#0000
0015	SystemInfo (%MB32768)
0016	SystemTaskInfoArr (%MB32832)
0017	
0018	

10.14. PLC - Control: start and stop the motor

To modify the MB1 state, See “8.1.3.CiA402 state chart”.

Example to start motor:

1. The MB1 is on “Switch on disabled” state.
2. Set “TSB_MB1_RPDO_Output1_Control_Word (%QB0)” = 0x0006
3. The MB1 is on “Ready to switch on” state.
4. Set “TSB_MB1_RPDO_Output1_Control_Word (%QB0)” = 0x0007
5. The MB1 is on “Switch on” state.
6. Set “TSB_MB1_RPDO_Output1_Control_Word (%QB0)” = 0x000F
7. The MB1 is on “Operational enable” state.
8. Set “TSB_MB1_RPDO_Output2_Target_Velocity (%QB2)” = 0x05DC
9. The Motor starts, and the MB1 displays “50.0”Hz
10. Set “TSB_MB1_RPDO_Output1_Control_Word (%QB0)” = 0x0000
11. The motor stops and MB1 go back on “Switch on disabled” state.

Example for exchanges with ESM states

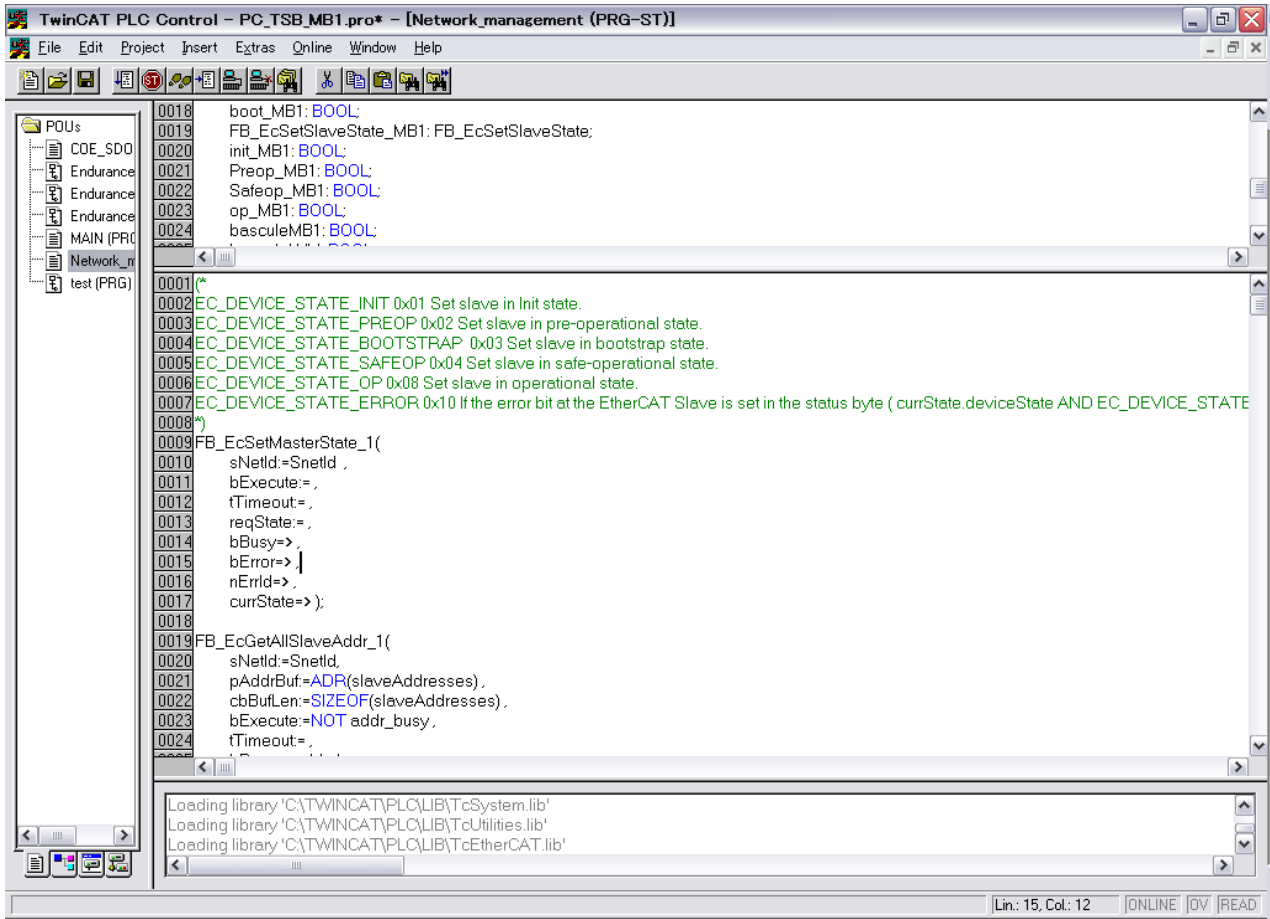

10.16. Method of add the PDOs

Select the "Process Data" tag

- ① Select the "PDO List" (Inputs or Outputs)
- ② Select the "PDO content"
- ③ Right click and select the "Insert..."

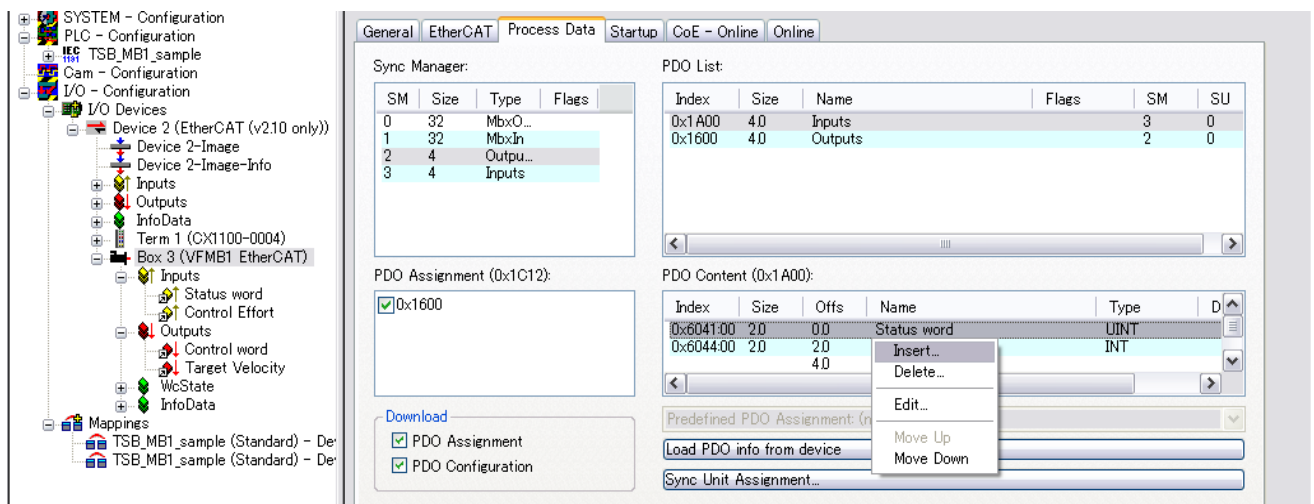

The image shows a software dialog box titled "Edit Pdo Entry". It contains several input fields and a list of options. Four callout boxes with arrows point to specific fields:

- Set the Name of PDO:** Points to the "Name:" text input field.
- Set the Index of PDO:** Points to the "Index (hex):" field, which contains the value "0".
- Set the Sub Index of PDO:** Points to the "Sub Index:" field, which contains the value "0".
- Set the Data Type of PDO:** Points to the "Data Type:" dropdown menu, which is currently set to "(none)".

Other fields in the dialog include "Bit Length:" set to "1", "OK" and "Cancel" buttons, and a "From Dictionary:" list with the following items:

- 0x2880 - Free notes
- 0x2C91 - Alarm code
- 0x2D00 - Output frequency (Real time)
- 0x2D01 - Inverter status (Real time)
- 0x2D03 - Output current (Real time)
- 0x2D04 - Voltage at DC bus (Real time)
- 0x2D05 - Output voltage (Real time)
- 0x2D06 - Status of input terminal block
- 0x2D07 - Status of output terminal block
- 0x2D16 - Estimated speed (Real time)
- 0x2D18 - Torque
- 0x2D20 - Torque current
- 0x2D22 - Feedback value of PID (Real time)
- 0x2D23 - Motor overload
- 0x2D24 - Inverter overload

