

| CPU Specifications | | | | | | | | | | | | | | | |
|---|---|-----------------------|-----|-----------------|-----------------|-----------------|------------------|----------------|------------------|---------------|----------|-----------------|-------|----------------|----------------|
| User Memory | 50MB (Includes program, data and documentation) | | | | | | | | | | | | | | |
| Memory Type | Flash and Battery Backed RAM | | | | | | | | | | | | | | |
| Retentive Memory | 500kB | | | | | | | | | | | | | | |
| Scan Time | 1.7 ms (1K Boolean, 240 I/O) | | | | | | | | | | | | | | |
| External Power Required | 24VDC ±2% @ 5W plus 1.25 W per additional I/O module In-Rush 35A** See page 6 for Power Supply Options | | | | | | | | | | | | | | |
| Protection Circuit | Edison S5062-R, Time Delay, 2A Fuse (15 I/O Modules) | | | | | | | | | | | | | | |
| Communications; 5 Integrated Ports | <p>USB: Programming, Monitoring, Debug, Firmware</p> <p>ETHERNET: (10/100Mbps Ethernet) Programming, Monitoring, Debug, Firmware, Email SMTP Client, Modbus TCP Client (32 Servers) and Server (16 Clients), EtherNet/IP Scanner (32 Adapters) and Adapter (4 scanners) with 8 connections per device. Custom Protocol over Ethernet, ProNet, MQTT.</p> <p>REMOTE I/O: 16 GS Drives*, 4 ProtosX TCP couplers, 4 P1-RX remote bases, 1 PS-AMC module</p> <p>RS-232: (RJ12, 1200-115.2k Baud) ASCII, Modbus</p> <p>RS-485: Removable Terminal Included, (1200-115.2k Baud) ASCII, Modbus RTU</p> | | | | | | | | | | | | | | |
| Data Logging | MicroSD card slot | | | | | | | | | | | | | | |
| Hardware Limits of System | <p>5 Base Groups: 1 local (P1-550) + 4 Remote (P1-RX)</p> <p>752 Hardware I/O Points All local and remote 16-point I/O Modules)</p> | | | | | | | | | | | | | | |
| Instruction Types | <table border="0"> <tr> <td>Application Functions</td> <td>PID</td> </tr> <tr> <td>Array Functions</td> <td>Program Control</td> </tr> <tr> <td>Counters/Timers</td> <td>String Functions</td> </tr> <tr> <td>Communications</td> <td>System Functions</td> </tr> <tr> <td>Data Handling</td> <td>Contacts</td> </tr> <tr> <td>Drum Sequencers</td> <td>Coils</td> </tr> <tr> <td>Math Functions</td> <td>Motion Control</td> </tr> </table> | Application Functions | PID | Array Functions | Program Control | Counters/Timers | String Functions | Communications | System Functions | Data Handling | Contacts | Drum Sequencers | Coils | Math Functions | Motion Control |
| Application Functions | PID | | | | | | | | | | | | | | |
| Array Functions | Program Control | | | | | | | | | | | | | | |
| Counters/Timers | String Functions | | | | | | | | | | | | | | |
| Communications | System Functions | | | | | | | | | | | | | | |
| Data Handling | Contacts | | | | | | | | | | | | | | |
| Drum Sequencers | Coils | | | | | | | | | | | | | | |
| Math Functions | Motion Control | | | | | | | | | | | | | | |
| Real Time Clock Accuracy | <p>+/-2s per day typical at 25°C</p> <p>+/-10s per day maximum at 60°C</p> | | | | | | | | | | | | | | |

*GS drive requires communication module/ card **Rev B and Higher

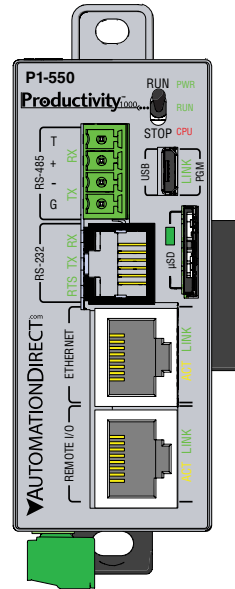

P1-550 CPU

The P1-550 is a full-featured, high-performance CPU for use with the Productivity1000 System.

| | |
|---|---|
| CPU Specifications | 1 |
| CPU Front Panel | 2 |
| Module Installation Procedure | 2 |
| Battery Installation Procedure | 3 |
| Micro SD Specifications | 3 |
| Port Specifications | 4 |
| Micro USB Specifications | 5 |
| CPU Status Indicators | 6 |
| CPU Stop/Run Switch Specifications | 6 |
| Removable Terminal Block Specifications | 6 |
| General Specifications | 8 |
| Warning | 8 |

Battery Installation Procedure

Step One:

Open battery compartment located on the top of the CPU and pull up to locked position.

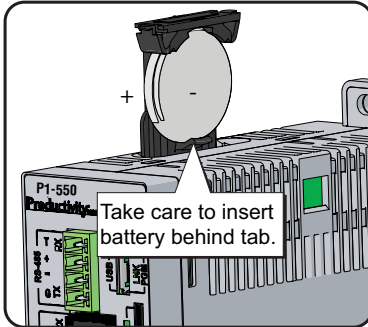
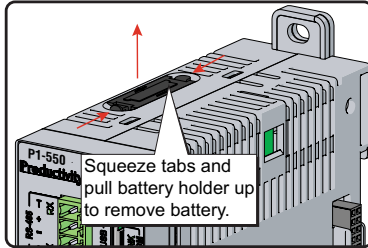

Step Two:

Insert battery under top two tabs in battery compartment. Press and snap battery behind bottom tab then close the battery compartment.

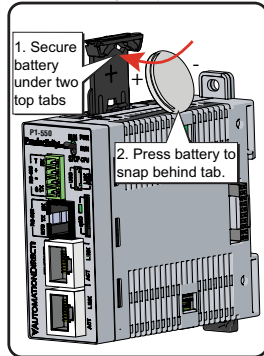

Battery (Optional)

D2-BAT-1 Coin type, 3.0V Lithium battery, 560mA, battery number CR2354

Note: Although not needed for program backup, an uninstalled battery is included with the P1-550. Install this battery if you want the CPU to retain the Time and Date along with any Tagname values that you have set up as retentive.

microSD Specifications

| Port Name | microSD | | | |
|--|---|---------|---------|------|
| Description | Standard microSD socket for data logging | | | |
| Maximum Card Capacity | 32GB | | | |
| Transfer Rate (ADATA microSDHC Class 4 memory card) | Minimum | Typical | Maximum | |
| | Read | 14.3 | 14.4 | 14.6 |
| | Write | 4.8 | 4.9 | 5.1 |
| Port Status LED | Green LED is illuminated when card is inserted/detected | | | |

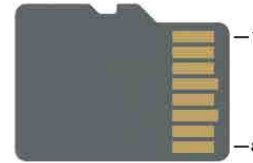

NOTE: Card not included with unit.

| Pin | SD |
|-----|---------|
| 1 | DAT2 |
| 2 | CD/DAT3 |
| 3 | CMD |
| 4 | VDD |
| 5 | CLK |
| 6 | VSS |
| 7 | DAT0 |
| 8 | DAT1 |

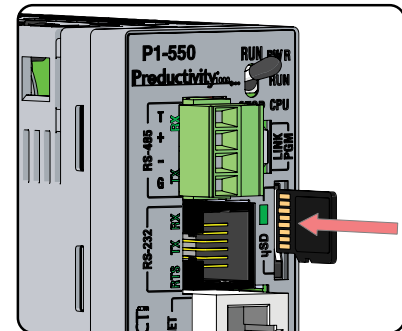

Port Specifications

RS-232 Specifications

| | |
|--|--|
| Port Name | RS-232 |
| Description | Non-isolated RS-232 DTE port connects the CPU as a Modbus/ASCII master or slave to a peripheral device. Includes ESD and built-in surge protection |
| Data Rates | Selectable, 1200, 2400, 4800, 9600, 19200, 33600, 38400, 57600, and 115200 |
| +5V Cable Power Source | 210mA maximum at 5V, ±5%. Reverse polarity and overload protected |
| TXD | RS-232 Transmit output |
| RXD | RS-232 Receive input |
| RTS | Handshaking output for modem control |
| GND | Logic ground |
| Maximum Output Load (TXD/RTS) | 3kΩ, 1000 pf |
| Minimum Output Voltage Swing | ±5 V |
| Output Short Circuit Protection | ±15 mA |
| Port Status LED | Green LED is illuminated when active for TXD, RXD and RTS |
| Cable Options | EA-MG-PGM-CBL D2-DSCBL USB-RS232 with D2-DSCBL FA-CABKIT FA-ISOCOON for converting RS-232 to isolated RS-485 |

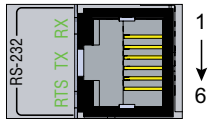

6-pin RJ12 Female Modular Connector

| Pin # | Signal |
|-------|-------------------|
| 1 | GND Logic Ground |
| 2 | +5V 210mA Maximum |
| 3 | RXD RS-232 Input |
| 4 | TXD RS-232 Output |
| 5 | RTS RS-232 Output |
| 6 | GND Logic Ground |

RS-485 Port Specifications

| | |
|---|--|
| Port Name | RS-485 |
| Description | Non-isolated RS-485 port connects the CPU as a Modbus/ASCII master or slave to a peripheral device. Includes ESD/EFT protection and automatic echo cancellation when transmitter is active |
| Data Rates | Selectable, 1200, 2400, 4800, 9600, 19200, 33600, 38400, 57600, and 115200 |
| TXD+/RXD+ | RS-485 transceiver high |
| TXD-/RXD- | RS-485 transceiver low |
| GND | Logic ground |
| Input Impedance | 19kΩ |
| Termination Resistance (TB Jumper wire "T" to "+") | 120Ω. To use, add jumper between "T" and "+". Resistor is internally connected between "T" and "-". |
| Maximum Load | 50 transceivers, 19kΩ each, 60Ω termination |
| Output Short Circuit Protection | ± 250mA, thermal shut-down protection |
| Electrostatic Discharge Protection | ± 8KV per IEC1000-4-2 |
| Electrical Fast Transient Protection | ± 1KV per IEC1000-4-4 |
| Minimum Differential Output Voltage | 1.5 V with 60Ω load |
| Fail Safe Inputs | Logic high input state if inputs are unconnected |
| Maximum Common Mode Voltage | -7.5 V to 12.5 V |
| Port Status LED | Green LED illuminated when active for TXD and RXD |
| Cable Options | Go to AutomationDirect.com for RS-232 and RS-485 cables |

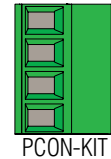
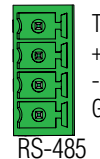

| Pin # | Signal |
|-------|-------------|
| T | TERMINATION |
| + | TXD+/RXD+ |
| - | TXD-/RXD- |
| G | GND |

Port Specifications

| Ethernet Specifications | | |
|-------------------------|---|---|
| Port Name | ETHERNET | REMOTE I/O |
| Description | Standard transformer isolated Ethernet port with built-in surge protection for programming, online monitoring and Ethernet communication protocols. See table on page 1 for supported devices and protocols. | Standard transformer isolated Ethernet port with built-in surge protection for connection to supported remote I/O devices. See table on page 1 for supported remote I/O devices. |
| Transfer Rate | 10Mbps (Orange LED) and 100Mbps (Green LED) (auto-crossover) | |
| Port Status LED | LED is solid when network LINK is established. LED flashes when port is active (ACT). | |

| Micro USB Type B Slave Input Specifications | |
|---|---|
| Port Name | MICRO USB |
| Description | Standard Micro USB Slave input for programming and online monitoring, with built-in surge protection. Not compatible with older full speed USB devices. |
| Transfer Rate | 480 Mbps |
| Port Status LED | Green LED is illuminated when LINK is established to programming software. |
| Cables | USB Type A to Micro USB Type B: 6ft cable part # USB-CBL-AMICB6 15ft cable part # USB-CBL-AMICB15 |

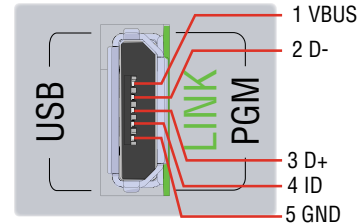
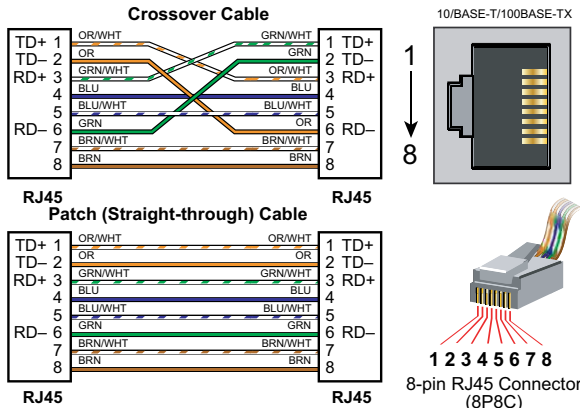

| CPU Status Indicators | |
|-----------------------|---|
| PWR | Green LED is illuminated when power is ON |
| RUN | Green LED is illuminated when CPU is in RUN mode |
| CPU | Red LED is illuminated during power ON reset, power down, or watch-dog time-out |

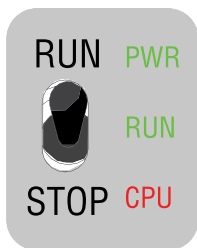

| CPU Run/Stop Switch Specifications | |
|------------------------------------|---|
| RUN position | Executes user program, run-time edits possible |
| STOP position | Does not execute user program, normal program load position |

| Removable Terminal Block Specifications | |
|---|---|
| Part Number | PCON-KIT |
| Number of Positions | 3 Screw Terminals |
| Pitch | 3.5 mm |
| Wire Range | 28–16 AWG Solid Conductor 28–16 AWG Stranded Conductor |
| Screw Driver Width | 1/8 in (3.175 mm) Maximum |
| Screw Size | M2 |
| Screw Torque | 1.7 lb-in (0.4 N-m) |

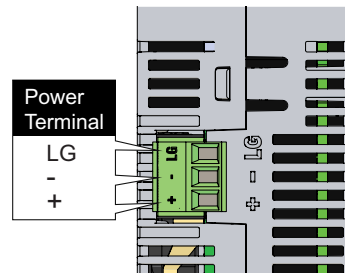

Productivity1000 Power Supplies

All Productivity1000 PLC CPUs require 24VDC input power from either a P1000 power supply or other 24VDC $\pm 2\%$ external power supply.

- P1-01AC: AC Input 85–132 / 170–264 VAC, 16W (power for CPU and up to 8 modules)
- P1-02AC: AC Input 85–132 / 170–264 VAC, 26W (power for CPU and up to 15 modules)
- P1-01DC: DC Input 12–24 VDC, 16W (power for CPU and up to 8 modules)
- The LG and minus terminals on the external power supply connection are internally shorted.
- Use different 24VDC supplies for the CPU and inductive loads to keep the CPU power clean and free of voltage spikes caused by switching inductive loads

General Specifications

| | |
|------------------------------|--|
| Operating Temperature | 0° to 60°C (32° to 140°F), |
| Storage Temperature | -20° to 70°C (-4° to 158°F) |
| Humidity | 5 to 95% (non-condensing) |
| Altitude | 2,000 meters max |
| Pollution Degree | 2 |
| Environmental Air | No corrosive gases permitted |
| Vibration | IEC60068-2-6 (Test Fc) |
| Shock | IEC60068-2-27 (Test Ea) |
| Heat Dissipation | 5020mW |
| Overvoltage Category | II |
| Enclosure Type | Open Equipment |
| Module Location | Controller connector on the side of the power supply in a Productivity1000 System. |
| Weight | 130g (4.5 oz) |
| Agency Approvals | UL 61010-1 and UL 61010-2-201 file E139594, Canada & USA CE (EN 61131-2 EMC, EN 61010-1 and EN 61010-2-201 Safety)* |

*See CE Declaration of Conformance for details.

WARNING: To minimize the risk of potential safety problems, you should follow all applicable local and national codes that regulate the installation and operation of your equipment. These codes vary from area to area and it is your responsibility to determine which codes should be followed, and to verify that the equipment, installation, and operation are in compliance with the latest revision of these codes.

Equipment damage or serious injury to personnel can result from the failure to follow all applicable codes and standards. We do not guarantee the products described in this publication are suitable for your particular application, nor do we assume any responsibility for your product design, installation, or operation.

If you have any questions concerning the installation or operation of this equipment, or if you need additional information, please call Technical Support at 770-844-4200.

This publication is based on information that was available at the time it was printed. At AutomationDirect.com® we constantly strive to improve our products and services, so we reserve the right to make changes to the products and/or publications at any time without notice and without any obligation. This publication may also discuss features that may not be available in certain revisions of the product.

CAUTION Battery May Explode If Mistreated.
Do Not Recharge, Disassemble or Dispose Of In Fire

| Document Name | Edition/Revision | Date |
|---------------|---------------------|-----------|
| P1-550-DS | 3rd Edition, Rev A2 | 7/12/2024 |

Copyright 2018, AutomationDirect.com Incorporated/All Rights Reserved Worldwide